ALYCO

NUESTRA HISTORIA

Desde 1912 Alyco ha evolucionado de un fabricante de machetes y barrenas para la industria, a suministrador global de herramientas manuales. Nos hemos ido adaptando a los tiempos anteponiendo siempre las necesidades de nuestros clientes. Nuestro último hito ha sido el traslado a nuestras nuevas instalaciones en Itziar, donde continuaremos nuestra misión como empresa.

DISEÑO & CALIDAD

Diseñamos todos nuestros productos siguiendo los estándares más exigentes tanto en seguridad como en ergonomía. Además trabajamos continuamente para incorporar nuevas prestaciones y fabricar el mejor producto posible.



MISIÓN

Proveer herramientas profesionales de mano a nuestros clientes cumpliendo con sus necesidades y contribuir a mantener nuestra historia industrial centenaria.

VISIÓN

Hacer sostenible nuestro negocio convirtiéndonos en referente del mercado nacional en Servicio y Calidad. Ampliar nuestro catálogo y llevar nuestra experiencia al mercado internacional, impulsando de esta manera el crecimiento de la compañía.

VALORES

Honestidad / Transparencia y responsabilidad social / Pasión / Orientación al cliente.



NUEVO CATÁLOGO ALYCO

Tras la fase de integración de catálogos realizada en la versión 2022, os presentamos esta nueva versión 2024, con más de 1.800 referencias nuevas.

UN ÚNICO CATÁLOGO PARA TODOS NUESTROS PRODUCTOS.

Hemos rediseñado el packaging de más de 2.500 referencias para tener una imagen más actualizada que de uniformidad a la presentación en tienda de nuestros productos.



En este proceso de rediseño, hemos aprovechado para minimizar tanto plásticos como cartones, aumentando nuestro compromiso con el medio ambiente.



ALYCO ORANGE

Alyco Orange está compuesta por unas 450 referencias que son la entrada a la gama profesional. Nos gusta definir las como herramientas profesionales para un uso menos intensivo.



ALYCO ORANGE

Encontraras la gama Orange en casi todas nuestras familias a lo largo del catálogo. La gama viene identificada mediante el icono naranja de la llave y el engranaje, siempre a la derecha del título del producto.

Esta gama se presenta habitualmente en color naranja y gris, y tiene sus propios diseños de packaging para una fácil identificación.

Encontrarás fácilmente la gama Orange en nuestra B2B donde podrás elegir entre la gama Alyco y la gama Alyco Orange.

UNA HERRAMIENTA B2B DISEÑADA PARA EL CLIENTE

Seguimos desarrollando nuestra B2B para dotarla de nuevas funcionalidades interesantes para nuestros agentes y clientes. Recientemente hemos incorporado una nueva página de inicio, a través de la cual poder controlar toda la información desde promociones personalizadas hasta pedidos, albaranes, etc. Todo comienza a partir de nuestro QR, desde donde puedes acceder a todo nuestro universo digital o entrando directamente en la B2B.

01

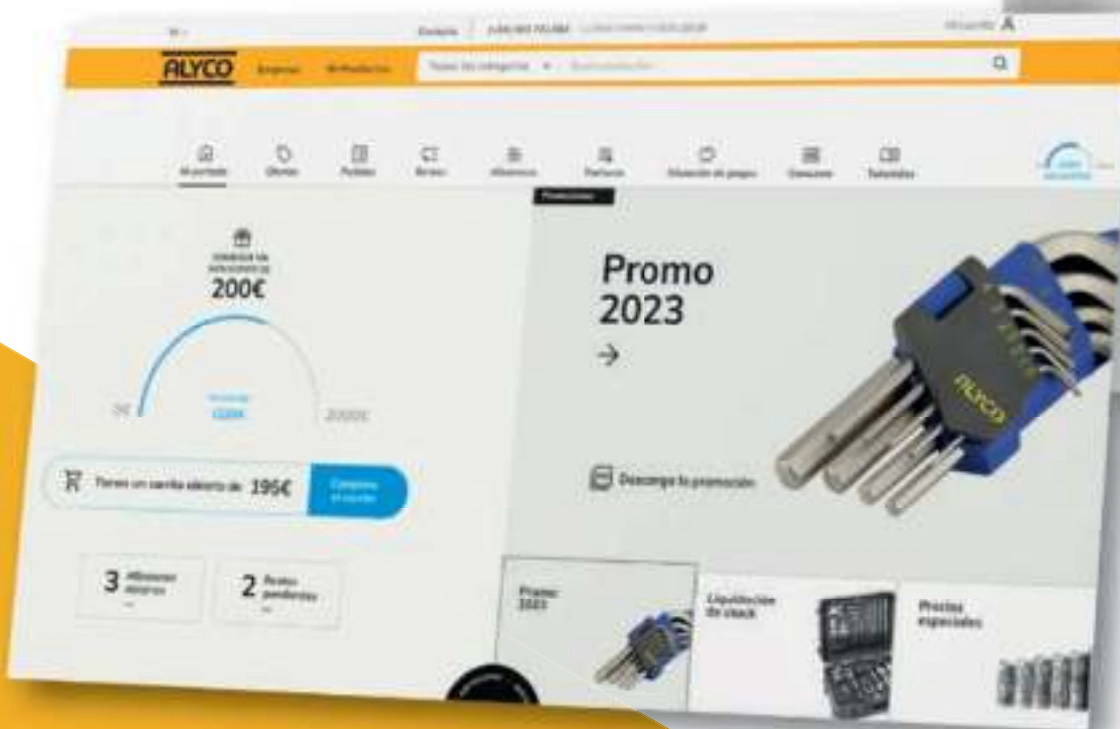

01

NUEVA HOME

La nueva Home permite moverse por la B2B con mayor facilidad. Puedes ir a cualquier menú o ver las promociones en vigor desde la misma página. El nuevo diseño persigue que tengas todo más a mano para hacerte la navegación más fácil y amena.

02

NUEVA FICHA DE PRODUCTO

Cada producto cuenta con su propia ficha donde puedes consultar todos los documentos, especificaciones e incluso videos sobre el mismo. Las fichas de producto se actualizan constantemente con nuevos contenidos.

02



03



03

CONSULTA DE LISTADOS, FACTURAS, ALBARANES

Consulta en un solo vistazo los productos seleccionados, si están en nuestro stock y el total de la compra. Además, podrás subir pedidos de muchas líneas de una manera muy rápida a través de un CSV.

04

UN CARRITO MUY VISUAL

El carrito muestra las condiciones especiales que se pueden dar en ferias virtuales o presenciales, ofertas y promociones, precios especiales, etc.

COMPROMISO DE SERVICIO

Condiciones vigentes a la fecha
01/05/2024 para península Ibérica.

100% SEGURO 100% RÁPIDO



25kg MÁX



14h del día siguiente

CERTIFICADOS DE CALIDAD

Disponemos de certificados a nivel de empresa que certifican que cumplimos con todos los estándares de calidad a nivel de organización y, a nivel de producto, que corroboran que todos aquellos artículos que precisan de una certificación especial, cumplen todos las normativas exigidas a nivel nacional y europeo.



TARIFA DE PRECIOS

CONDICIONES DE LA TARIFA

PRECIOS



(P.V.P.) Precio Venta Público recomendado.
Impuestos no incluidos.

PEDIDO MÍNIMO



No hay cifra de pedido mínimo.

PAGOS



A los 60 días de fecha de factura por recibo domiciliado o transferencia.

VIGENCIA DE ESTA TARIFA



Esta tarifa anula cualquier otra edición anterior. Alyco se reserva el derecho de modificar los modelos sin previo aviso. Las especificaciones de este catálogo no constituyen un compromiso contractual.

PORTES



Los portes serán pagados por Alyco cuando la suma del importe neto supere los siguientes importes:

1. España peninsular: 100 €.
2. Portugal peninsular: 150 €.
3. Baleares: 300 €.
4. Canarias, Ceuta y Melilla: 900 €.

En caso de portes en factura, cobraremos 9 € en factura en España peninsular y 12 € en Baleares y Portugal. Cuando se use la agencia del cliente, se cargarán 9 € por gastos de gestión.

OTRAS CONDICIONES DE VENTA

COMPROBACIÓN DE ENVÍO



Para reclamaciones por faltas de producto comprobar que los cierres de los paquetes no están abiertos antes de firmar el albarán de la agencia de transporte. En caso contrario hacer constar en el albarán la incidencia y reclamar en menos de 24 horas a Alyco.

DEVOLUCIÓN DE LA MERCANCÍA



Se aceptará por error de envío o por defectos atribuibles a Alyco, dentro de los 30 días siguientes a la fecha de expedición.

DESCARGA DEL FICHERO DE PRECIOS



Puedes descargar el fichero Excel de código, descripción, precio, código de barras y página de catálogo en la página www.alycotools.com/ descargas

DESCARGA DE IMÁGENES DE PRODUCTOS



Puedes descargar las imágenes de todos nuestros productos en la pág. www.raizferretera.com (solicitar claves e instrucciones)

GARANTÍA



Todos los artículos están garantizados contra defectos de materiales o fabricación. Esta garantía cubre exclusivamente el cambio o reparación de las herramientas defectuosas.

NUESTRAS INSTALACIONES

La alta automatización de nuestras instalaciones nos permite expedir más del 85% de nuestras referencias desde almacenes robotizados, disminuyendo el tiempo de gestión interna de los pedidos.



UBICACIÓN & CONTACTO



NÚMERO DE TELÉFONO

+34 943 741 604

HORARIO

Horario ininterrumpido de atención al público:

De 07:00 a 19:00 de lunes a jueves.

De 07:00 a 18:00 los viernes.

DIRECCIÓN

Pol. Industrial Itziar, T1; Itziar-Deba 20829.
Guipúzcoa (Spain)

CORREO ELECTRÓNICO

alyco@alycotools.com

ÍNDICE GRÁFICO

01

MONTAJES
PÁGS. 15-36



02

ALMACENAJE
PÁGS. 37-84



03

**ALICATES Y
CORTANTES**
PÁGS. 85-118



04

LLAVES
PÁGS. 119-150



05

LLAVES MACHO
PÁGS. 151-162



06

**DESTORNILLADORES
Y PUNTAS**
PÁGS. 163-188



07

LLAVES DE VASO
PÁGS. 189-224



08

PERCUSIÓN

PÁGS. 225-242



09

CORTE Y TALADRADO

PÁGS. 243-268



10

JARDINERÍA

PÁGS. 269-274



11

CONSTRUCCIÓN

PÁGS. 275-292



12

ACCESORIOS DE PINTURA

PÁGS. 293-300



13

FONTANERÍA Y MEDICIÓN

PÁGS. 301-322



14

ILUMINACIÓN Y ELECTRICIDAD

PÁGS. 323-342



ÍNDICE GRÁFICO

15

HERRAMIENTA VARIA

PÁGS. 343-368



16

HERRAMIENTA ANTICHISPA

PÁGS. 369-392



17

HERRAMIENTA DE TITANO

PÁGS. 393-400



18

HERRAMIENTA DE INOXIDABLE

PÁGS. 401-414



19

EXPOSITORES

PÁGS. 415-421



ÍNDICE DE PICTOGRAMAS

	QR que te lleva a la ficha de producto.		Tipo de enganche SDS Plus.
	Estándar DIN.		Número de dientes de la carraca.
	Alta potencia mecánica. Diseñado para reducir los esfuerzos.		Número de caras de la herramienta.
	Certificado VDE. Federación alemana de industrias electrónicas y de tecnología de la información.		Ángulo entre la cabeza de la llave y el mango.
	Nivel de tensión soportado.		Punta imantada.
	Advertencia o limitación de uso.		Con pivote.
	Boca para corte biselado.		Conexión hexagonal macho.
	Mango disipativo de energía estática.		Cabeza punta tipo bola.
	Marcado GS. Geprüfte Sicherheit.		Boca Torx inviolable.
	Bocas planas.		Boca Torx.
	Bocas redondas.		Boca hexagonal hembra.
	Puntas semiredondas.		Tipo de conexión y medida.
	Arandelas Seeger exteriores.		Tipo de conexión y medida.
	Arandelas Seeger interiores.		Conexión estandarizada.
	Para cables de fibra óptica.		Recubrimiento superficial.
	Terminal.		Punta con resalte para evitar deslizamientos.
	Terminal redondo.		Diseño especial para evitar sobrecargas y roturas.
	Terminal plano.		Boca plana.
	Terminal horquilla.		Boca Phillips o PH.
	Conector.		Boca Pozidrive o PZ.
	Terminal lengüeta.		Longitud de la punta de atornillar.
	Dirección corte.		Especial automoción.
	En pulgadas.		Punta especial destornillador.
	Aristas redondeadas.		Punta especial destornillador.

ÍNDICE DE PICTOGRAMAS

	Para uso con herramienta eléctrica.		Tiempo de carga.
	Lima triangular.		Tipo conexión.
	Lima cuadrada.		Gancho giratorio para colgar.
	Lima redonda.		Intensidad lúmenes.
	Lima media caña.		Alcance de la luz en línea recta.
	Lima plana.		Autonomía de la batería.
	Peso del producto.		Voltaje de carga.
	Punta especial destornillador.		Con clip.
	Punta especial destornillador.		Potencia máxima recomendada.
	Punta especial destornillador.		Tipo de conector eléctrico a la red.
	Capacidad de corte.		Carga máxima.
	Apto para vídeo.		Preparado para candado.
	Material de fabricación.		Cerradura centralizada.
	Medida carraca.		Especial construcción.
	Incluye cuchilla de recambio.		Sistema antivuelco.
	Atención láser.		Especial electricistas.
	Necesaria protección individual.		Anticorrosión.
	Medidas del producto.		Dimensión rueda.
	Marcado CE.		Longitud de cable.
	Nivel de protección o sellado.		Tipo de cable.
	Tipo de batería.		Clase energética.
	Tipo y potencia de LED.		Capacidad de apriete del tornillo.
	Impermeable.		Protección infantil.
	Carga máxima admisible.		

01

MONTAJES

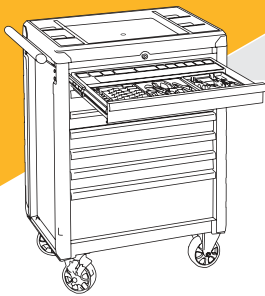

Carro con composición grande **17**

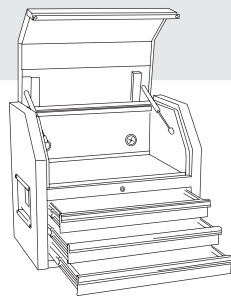

Arcón con composición pequeña **21**

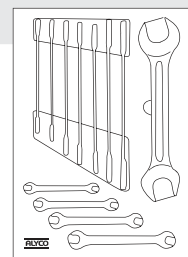

Bandeja de espuma para carro **23**



Maleta con herramientas **29**

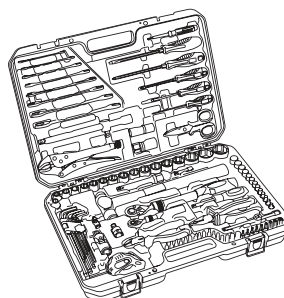

Juego combinado **31**

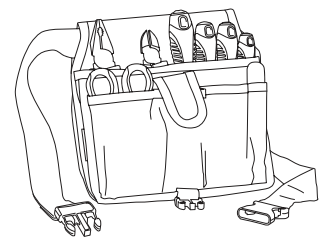

Bolsa con herramientas **33**

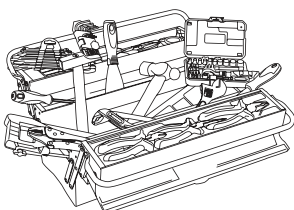

Caja con herramientas **34**

01



CARRO DE 7 CAJONES REFORZADO CON HERRAMIENTAS

Cód.	Descripción	Nº piezas	P.V.P unid. €
192826	CARRO + COMPOSICIÓN GRANDE	177	1.973,48
192827	CARRO + COMPOSICIÓN PEQUEÑA	80	1.465,87



Carro con accesorios

Características del carro en pág. 38 / Accesorios y recambios en páginas 45 a 49.



SISTEMA ANTIVUELCO



Cerradura centralizada



Ruedas Ø 5"x2"



Carga máxima



92 KG



482x1013x722 mm.

COMPOSICIÓN GRANDE
177 htas.



114060



114061



114062



114063



114053

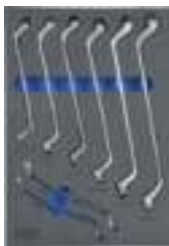

114057



114058



114056



114059



Carro 192825

COMPOSICIÓN PEQUEÑA
80 htas.



114060

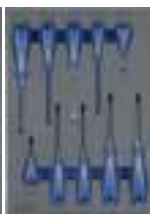

114058



114062



114053



114059



CARRO DE 7 CAJONES CON HERRAMIENTAS

Cód.	Descripción	Nº piezas	P.V.P unid. €
129727	CARRO + COMPOSICIÓN GRANDE	177	1.745,20
129724	CARRO + COMPOSICIÓN MEDIANA	142	1.247,43



Características del carro en pág. 39 / Accesorios y recambios en páginas 45 a 49.



SISTEMA ANTIVUELCO



Cerradura centralizada



Ruedas Ø 5"x2"



Carga máxima



480x980x700 mm.

COMPOSICIÓN GRANDE
177 htas.



114060



114061



114062



114063



114053

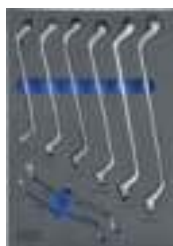

114057



114058



114056



114059



Carro 129725

COMPOSICIÓN MEDIANA
142 htas.



114060



114058



114062

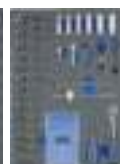

114063



114053

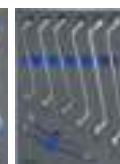

114057



114059

01



CARRO DE 7 CAJONES CON HERRAMIENTAS

Cód.	Descripción	Nº piezas	P.V.P. unid. €
192712	CARRO + COMPOSICIÓN GRANDE	177	1.610,45
192709	CARRO + COMPOSICIÓN MEDIANA	142	1.095,85



Características del carro en pág. 39 / Accesorios y recambios en páginas 45 a 49.



Cerradura centralizada



Ruedas Ø 5"x2"



Carga máxima



81 KG



458x993x699 mm.

COMPOSICIÓN GRANDE
177 htas.

114060 114061

114062 114063

114053 114057

114058 114056

114059



Carro 192710

COMPOSICIÓN MEDIANA
142 htas.

114060 114058 114062 114063 114053 114057 114059



CARRO DE 8 CAJONES CON HERRAMIENTAS

Cód.	Descripción	Nº piezas	P.V.P. unid. €
129716	CARRO + COMPOSICIÓN MAXI	200	1.635,20
129714	CARRO + COMPOSICIÓN MEDIANA	142	1.115,09



Características del carro en pág. 40 / Accesorios y recambios en páginas 45 a 49.



Cerradura centralizada



Ruedas Ø 5"x2"

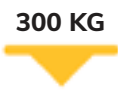

Carga máxima

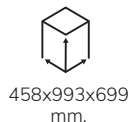

458x993x699 mm.

COMPOSICIÓN MAXI
200 htas.

114060 114061

114062 114063

114053 114054

114057 114051

114058 114056

114059



Carro 129715

COMPOSICIÓN MEDIANA
142 htas.

114060 114058 114062 114063 114053 114057 114059

01



BANCO DE TRABAJO MÓVIL CON HERRAMIENTAS

Cód.	Descripción	Nº piezas	P.V.P. unid. €
192679	BANCO + COMPOSICIÓN GRANDE	177	2.125,60
192680	BANCO + COMPOSICIÓN MEDIANA	142	1.605,24



192679



192680

Características del banco en pág. 41 / Accesorios y recambios en páginas 46 a 49.



Cerradura centralizada



Ruedas Ø 5"x2"



400 KG

Carga máxima



114 KG



458x1007x1067 mm.

**COMPOSICIÓN GRANDE
177 htas.**

114060 114061

114062 114063

114053 114057

114058 114056

114059



Banco 192678

**COMPOSICIÓN MEDIANA
142 htas.**

114060 114058 114062 114063 114053 114057 114059



CARRO DE 5 CAJONES CON HERRAMIENTAS

Cód.	Nº piezas	P.V.P. unid. €
129719	80	1.070,35

Características del carro en pág. 40.
Accesorios y recambios en páginas 45 a 49.



Cerradura centralizada



Ruedas
Ø 5"x2"



300 KG

Carga máxima



77 KG



458x993x699
mm.

COMPOSICIÓN PEQUEÑA
80 htas.



114060

114058

114062

114053

114059



Carro 129720



ARCÓN METÁLICO DE 3 CAJONES CON HERRAMIENTAS

Cód.	Nº piezas	P.V.P. unid. €
129704	80	991,71

Características del carro en pág. 43.
Accesorios y recambios en páginas 45 a 49.



Cerradura centralizada



90 KG

Carga máxima



45 KG



445x584x684
mm.

COMPOSICIÓN PEQUEÑA
80 htas.



114060

114058

114062

114053

114059



Arcón 129705

01



CARRO DE 6 CAJONES CON HERRAMIENTAS



Cód.	Descripción	Nº piezas	P.V.P. unid. €
170862	CARRO CON HERRAMIENTAS	164	935,16

Características del carro en pág. 42 / Accesorios y recambios en páginas 46 a 49.



Cerradura centralizada



Ruedas Ø 5"x2"

250 KG



Carga máxima



61 KG



460x1020x680 mm.



Carro 170860

COMPOSICIÓN
164 htas.



170906



170900



170902



170904



CARRO DE 2 CAJONES + PORTÓN



Cód.	Descripción	Nº piezas	P.V.P. unid. €
170873	CARRO CON HERRAMIENTAS	70	700,06

Características del carro en pág. 42 / Accesorios y recambios en páginas 46 a 49.



Cerradura centralizada



Ruedas Ø 5"x2"

200 KG



Carga máxima



41 KG



460x860x680 mm.



Carro 170871

COMPOSICIÓN
70 htas.



170906



170900



170904



BANDEJA DE ESPUMA CON ALICATES

COMPOSICIÓN

1	101202 Alicate Universal 180 mm.	1	110303 Alicate corte diagonal 180 mm.
1	101302 Alicate bocas semiredondas 200 mm.	1	108015 Tijera multiusos 145 mm.
1	115105 Tenacilla canal 250 mm.		

Cód.	Nº piezas	P.V.P. unid. €	
114060	5	150,27	1

279x35x398
mm.

BANDEJA DE ESPUMA CON ALICATES AISLADOS

CERTIFICADO **VDE**

COMPOSICIÓN

1	101802 Alicate Universal 180 mm.	1	101822 Alicate corte diagonal 180 mm.
1	101811 Alicate bocas semiredondas 200 mm.	1	108315 Tijera multiusos 165 mm.
1	101845 Tenacilla canal 240 mm.		



Cód.	Nº piezas	P.V.P. unid. €	
114064	5	150,27	1

279x35x398
mm.

BANDEJA DE ESPUMA CON ALICATES Y TENAZAS

COMPOSICIÓN

1	106203 Ext. Recto Ø 19-60 mm.	1	106207 Ext. Curvo Ø 19-60 mm.
1	106210 Int. Recto Ø 19-60 mm.	1	106213 Int. Curvo Ø 19-60 mm.
1	109103 Tenaza grip bocas curvas 235 mm.	1	172252 Llave ajustable 250 mm.

Cód.	Nº piezas	P.V.P. unid. €	
114061	6	126,76	1

279x35x398
mm.

BANDEJA DE ESPUMA CON LLAVES FIJAS

COMPOSICIÓN

12	6x7, 8x9, 10x11, 12x13, 14x15, 16x17, 18x19, 20x22, 21x23, 24x27, 25x28, 30x32 mm.
----	---

Cód.	Nº piezas	P.V.P. unid. €	
114053	12	82,28	1

279x35x398
mm.

01



BANDEJA DE ESPUMA CON LLAVES COMBINADAS

COMPOSICIÓN

12
6, 7, 8, 9, 10, 11, 12, 13, 14, 17, 19, 22 mm.

Cód.	Nº piezas	P.V.P. unid. €	
114054	12	77,44	1



279x35x398 mm.



BANDEJA DE ESPUMA CON LLAVES DE ESTRELLA ACODADAS

COMPOSICIÓN

8
6x7, 8x9, 10x11, 12x13, 14x15, 16x17, 18x19, 20x22 mm.

Cód.	Nº piezas	P.V.P. unid. €	
114057	8	73,55	1



279x35x398 mm.

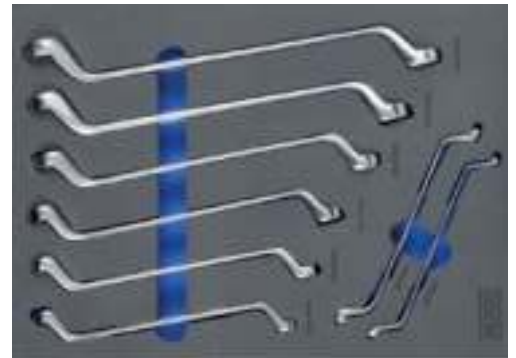

BANDEJA DE ESPUMA CON DESTORNILLADORES

COMPOSICIÓN

5
3,0x100, 4,0x100, 5,5x100, 6,5x125, 6,5x38 mm.

3
PH1x100, PH2x100, PH2x38 mm.

2
PZ1x100, PZ2x100 mm.

Cód.	Nº piezas	P.V.P. unid. €	
114058	10	48,32	1



279x35x398 mm.

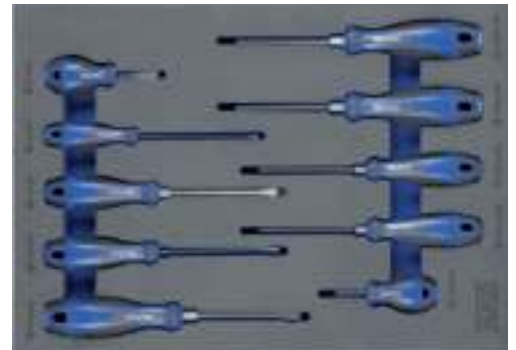

BANDEJA DE ESPUMA CON DESTORNILLADORES AISLADOS

CERTIFICADO **VDE**

COMPOSICIÓN

3
3,0x100, 4,0x100, 5,5x100 mm.

2
PH1x100, PH2x100 mm.

2
PZ1x100, PZ2x100 mm.

1
Tester 3x140 mm.



Cód.	Nº piezas	P.V.P. unid. €	
114065	8	41,64	1



279x35x398 mm.

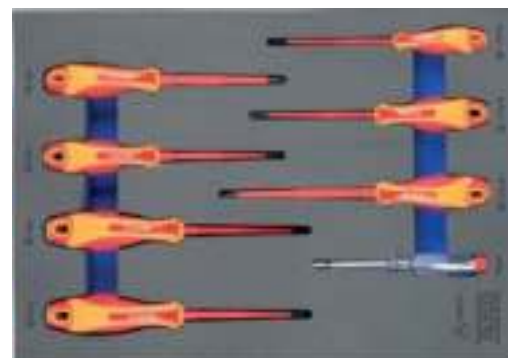



BANDEJA DE ESPUMA CON MANGOS EN T

COMPOSICIÓN

8 2,0 - 2,5 - 3,0 - 4,0 - 5,0 - 6,0 - 8,0 - 10,0 mm.

Cód.	Nº piezas	P.V.P. unid. €	
114055	8	42,92	1

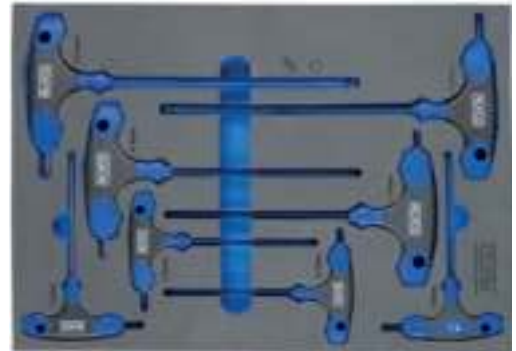

BANDEJA DE ESPUMA CON LLAVES ALLEN

COMPOSICIÓN

9 1,5 - 2,0 - 2,5 - 3,0 - 4,0
5,0 - 6,0 - 8,0 - 10,0 mm.

9 T10, T15, T20, T25, T27
T30, T40, T45, T50.

9 1,5 - 2,0 - 2,5 - 3,0 - 4,0
5,0 - 6,0 - 8,0 - 10,0 mm.

1 12 mm.

1 14 mm.

Cód.	Nº piezas	P.V.P. unid. €	
114056	29	51,59	1



BANDEJA DE ESPUMA CON LLAVES DE VASO DE 1/4"

COMPOSICIÓN

1 Carraca 1/4"
72 dtes.

6 Vasos largos 1/4"
6-13 mm.

13 Vasos 1/4"
4-14 mm.

1 Atornillador 1/4"
150 mm.

2 Alargaderas 1/4"
50, 150 mm.

1 Alargadera flexible 1/4"
150 mm.

1 Junta universal
1/4"

1 Adapt. vasos
1/4"

1 Adaptador puntas
1/4"

1 Adaptador
3/8" H x 1/4" M

4 Llaves allen
1,27 - 1,50
2,00 - 2,50 mm.

3 Vasos 1/4"
con punta plana
4,0 - 5,5 - 7,0 mm.

3 Vasos 1/4"
con punta Phillips
PH1, PH2, PH3

3 Vasos 1/4"
con punta Pozidrive
PZ1, PZ2, PZ3

6 Vasos 1/4" con punta hexagonal
3,0 - 4,0 - 5,0 - 6,0
7,0 - 8,0 mm.

6 Vasos 1/4"
con punta Torx
T10, T15, T20, T25, T30, T40

1 Caja de plástico

Cód.	Nº piezas	P.V.P. unid. €	
114063	54	73,18	1



BANDEJA DE ESPUMA CON LLAVES DE VASO DE 1/2"

COMPOSICIÓN

1 Carraca 1/2"
72 dtes.

1 Adaptador
1/2" M x 3/8" H

16 Vasos 1/2"
10-20, 22, 24, 27, 30, 32 mm.

1 Junta universal
1/2"

1 Adap. puntas
5/16"

5 Puntas Torx 5/16"
T40, T45, T50, T55, T60

2 Alargaderas
75, 250 mm.

1 Adapt. vasos
1/2"

2 Puntas Pozidrive 5/16"
PZ3, PZ4

3 Puntas Phillips 5/16"
PH2, PH3, PH4

3 Puntas planas 5/16"
8,0-10,0-12,0 mm.

3 Puntas Hexagonales 5/16"
8, 10, 12 mm.

Cód.	Nº piezas	P.V.P. unid. €	
114062	39	113,43	1



01  **BANDEJA DE ESPUMA CON MARTILLOS**

COMPOSICIÓN

-  1 Martillo peña
Ø 22 mm.
-  1 Martillo bocas nylon
Ø 34 mm.
-  1 Martillo bola
455 grs.

Cód.	Nº piezas	P.V.P. unid. €	
114052	3	43,58	1



279x35x398 mm.



 **BANDEJA DE ESPUMA CON LIMAS**

COMPOSICIÓN

-  Lima plana
100 mm.
-  Lima plana
200 mm.
-  Lima de media caña
100 mm.
-  Lima de media caña
200 mm.
-  Lima redonda
100 mm.
-  Lima redonda
200 mm.
-  Lima cuadrada
100 mm.
-  Lima cuadrada
200 mm.
-  Lima triangular
100 mm.
-  Lima triangular
200 mm.
-  Lima plana punta
100 mm.

Cód.	Nº piezas	P.V.P. unid. €	
114051	11	56,47	1

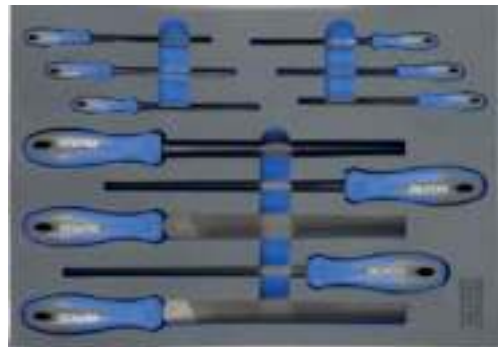

279x35x398 mm.



 **BANDEJA DE ESPUMA CON HERRAMIENTA VARIA**

COMPOSICIÓN

-  5 Botadores cilindricos
2, 3, 4, 5, 6 mm.
-  1 Granete
5 mm.
-  1 Prensaterminales
250 mm.
-  1 Martillo bola
455 grs.
-  1 Linterna bifocal
COB-LED 2W
-  1 Arco de sierra
400 mm.
-  1 Cutter
18 mm.
-  1 Flexómetro
3M
-  1 Cortafíos
250 mm.
-  1 Calibre digital
150 mm.

Cód.	Nº piezas	P.V.P. unid. €	
114059	14	120,58	1

558x35x398 mm.





COMPOSICIÓN PEQUEÑA PARA CARROS - 3 CAJONES

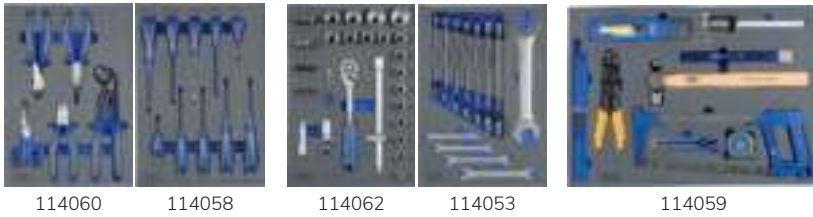

Cód.	Nº piezas	P.V.P. unid. €	
192704	80	552,00	1



COMPOSICIÓN MEDIANA PARA CARROS - 4 CAJONES



Cód.	Nº piezas	P.V.P. unid. €	
192701	142	698,74	1



COMPOSICIÓN GRANDE PARA CARROS - 5 CAJONES

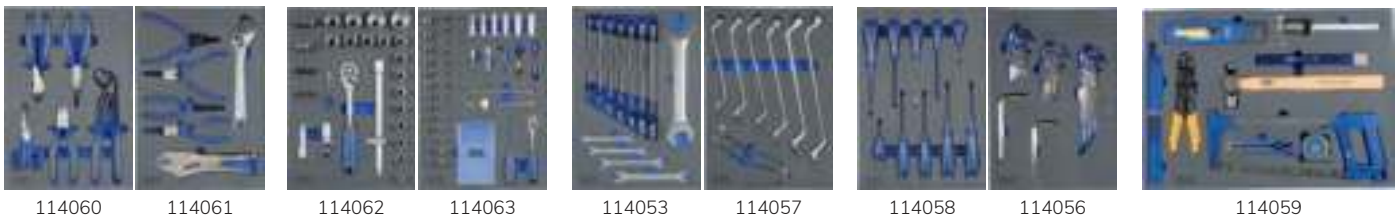

Cód.	Nº piezas	P.V.P. unid. €	
192714	177	877,08	1



COMPOSICIÓN MAXI PARA CARROS - 6 CAJONES

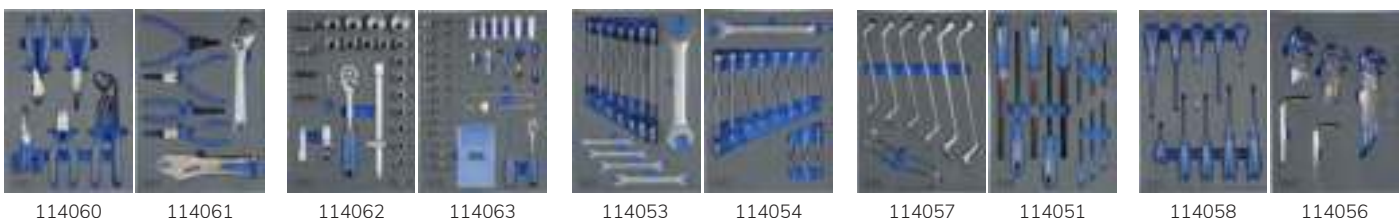

Cód.	Nº piezas	P.V.P. unid. €	
192713	200	932,54	1



114059

01



BANDEJA DE ESPUMA CON ALICATES, DESTORNILLADORES Y LLAVES MACHO



COMPOSICIÓN

- 4 Destornilladores planos 4,0 - 5,5 - 6,5 - 8,0 mm.
- 2 Destornilladores Phillips PH1, PH2
- 2 Destornilladores Pozidrive PZ1, PZ2
- 1 Tenaza pico de loro 250 mm.
- 9 Llaves allen bola 1,5 - 2 - 2,5 - 3 - 4 - 5 - 6 - 8 - 10 mm.
- 9 Llaves Torx inviolables T9, T10, T15, T20, T27, T30, T40, T50, T55
- 1 Alicata universal 180 mm.
- 1 Alicata corte diagonal 160 mm.
- 1 Alicata bocas semiredondas 200 mm.
- 1 Tenaza grip 235 mm.

Cód.	Nº piezas	P.V.P. unid. €	
170906	31	83,77	1



558x35x398 mm.



BANDEJA DE ESPUMA CON LLAVES



COMPOSICIÓN

- 8 Llaves fijas 6x7, 8x9, 10x11, 12x13, 14x15, 16x17, 18x19, 20x22 mm.
- 8 Llaves estrella acodadas 6x7, 8x9, 10x11, 12x13, 14x15, 16x17, 18x19, 20x22 mm.
- 12 Llaves combinadas 6, 7, 8, 9, 10, 11, 12, 13, 14, 17, 19, 22 mm.
- 1 Llave ajustable 250 mm.

Cód.	Nº piezas	P.V.P. unid. €	
170900	29	88,26	1



558x35x398 mm.

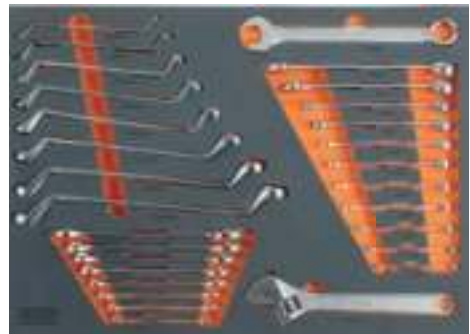

BANDEJA DE ESPUMA CON LLAVES DE VASO DE 1/4" Y 1/2"



COMPOSICIÓN 1/2"

- 18 Vasos 10 a 32 mm.
- 4 Vasos largos 14, 15, 17, 19 mm.
- 1 Carraca 72 dtes.
- 3 Llaves allen 1,5 - 2 - 2,5 mm.
- 2 Alargaderas 125, 250 mm.
- 1 Junta universal
- 1 Adaptador 1/2" M x 3/8" H
- 1 Adaptador puntas 5/16"
- 2 Llaves bujía 16, 21 mm.
- 15 Puntas 5/16"

COMPOSICIÓN 1/4"

- 13 Vasos 4 a 14 mm.
- 8 Vasos largos 6 a 13 mm.
- 1 Carraca 72 dtes.
- 17 Vasos con puntas
- 2 Alargaderas 50, 100 mm.
- 1 Alargadera flexible 150 mm.
- 1 Atornillador 150 mm.
- 1 Mango en "T" 100 mm.
- 1 Junta universal
- 1 Adapt. vasos 1/4" M x 1/4" M

Cód.	Nº piezas	P.V.P. unid. €	
170902	94	114,45	1



558x35x398 mm.

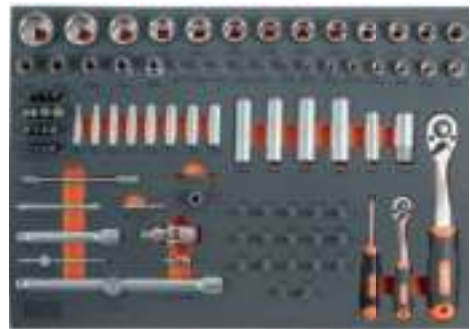

BANDEJA DE ESPUMA CON HERRAMIENTA VARIA



COMPOSICIÓN

- 1 Espátula 60 mm.
- 1 Nivel 400 mm.
- 1 Linterna bifocal COB-LED 3W
- 1 Martillo peña 30 mm.
- 1 Arco de sierra 430 mm.
- 1 Cutter 18 mm.
- 1 Flexómetro 3M
- 1 Cortafíos 250 mm.
- 1 Tornillo apriete 200 mm.
- 1 Tijera multiusos 145 mm.

Cód.	Nº piezas	P.V.P. unid. €	
170904	10	80,87	1



558x35x398 mm.





MALETA DE ALUMINIO REFORZADA CON HERRAMIENTAS

Cód.	Descripción	Nº piezas	P.V.P. unid. €
198101	MALETA + COMPOSICIÓN	45	402,00
198106	MALETA + BOLSA + COMPOSICIÓN	46	469,01



198101



198106



Maleta



Maleta + Bolsa

Características de la maleta en pág. 77 y de la bolsa en pág. 79.



Cerradura
doble



20
KG



340x205x482
mm.



Parte trasera del panel.

COMPOSICIÓN

1 101202 Alicata universal 180 mm.	1 110310 Alicata corte diagonal reforzado 180 mm.	1 101301 Alicata bocas semi-redondas con corte 160 mm.
1 111199 Tenaza pico loro 200 mm.	8 191080 Llaves fijas 6x7 a 20x22 mm.	1 109103 Tenaza grip 235 mm.
1 108015 Tijera multiusos	1 172252 Llave ajustable 250 mm.	1 196520 Martillo Peña 22 mm. hickory
1 144004 Arco de sierra	1 197512 Lima media caña 200 mm.	8 193082 Llaves allen 1,5 a 8 mm.
8 193283 Llaves Torx Inv. T9 a T40	1 186618 Cutter 18 mm.	1 197300 Flexómetro 3 metros
8 119055 Destornilladores: 1 3x100 (119023) (recto) 2 PZ1x100 (119041) PZ2x150 (119042)	3 4x80 (119004), 6.5x150 (119006), 8x150 (119008) (planos)	2 PH1x100 (119031) PH2x150 (119032)



Maleta 198100



MALETA DE ALUMINIO DE 1 PANEL CON HERRAMIENTAS

Cód.	Descripción	Nº piezas	P.V.P. unid. €
198111	MALETA + COMPOSICIÓN	24	185,17
198116	MALETA + BOLSA + COMPOSICIÓN	25	252,17



198111



198116



Maleta



Maleta + Bolsa

Características de la maleta en pág. 76 y de la bolsa en pág. 79.



Cerradura
doble



12
KG



330x152x455
mm.



Parte trasera del panel.

COMPOSICIÓN

1 101202 Alicata universal 180 mm.	8 191080 Llaves fijas 6x7 a 20x22 mm.	1 172252 Llave ajustable 250 mm.
1 196520 Martillo Peña 22 mm. hickory	1 144004 Arco de sierra	9 193070 Llaves allen 1,5 a 10 mm.
1 186618 Cutter 18 mm.	1 197300 Flexómetro 3 metros	



Maleta 198110

01



MALETA DE ALUMINIO DE 1 PANEL CON HERRAMIENTAS



Cód.	Nº piezas	P.V.P. unid. €
170822	120	272,45

Características de la maleta en pág. 77.



Cerradura doble



10 KG



330x152x455 mm.



COMPOSICIÓN 1/2" (39 piezas)

- | | | |
|---|------------------------------------|---------------------------------|
| 12 Vasos
15 a 32 mm. | 1 Carraca 1/2"
45 dientes | 2 Alargaderas
75, 250 mm. |
| 1 Junta universal | 1 Adaptador puntas
5/16" | 1 Adapt. vasos
1/2" |
| 1 Adaptador
3/8"H x 1/2"M | 3 Llaves allen
1.5, 2, 2.25 mm. | 1 Adapt. puntas
5/16" |
| 16 Puntas 5/16"
4 ⚙- 8, 10, 12, 14mm.
3 ⚙- 8, 10, 12mm. | 2 ⚙- PH3, PH4
2 ⚙- PZ3, PZ4 | 5 ⚙- T40, T45, T50,
T55, T60 |

COMPOSICIÓN 1/4" (46 piezas)

- | | | |
|--|--|--|
| 13 Vasos
4 a 14 mm. | 1 Carraca 1/4"
45 dientes | 1 Adapt. vasos
1/4" |
| 2 Alargaderas
50, 150 mm. | 1 Atornillador
150 mm. | 1 Adaptador
3/8"H x 1/4"M |
| 1 Junta universal | 1 Adaptador puntas
1/4" | 1 Adapt. puntas
1/4" |
| 24 Puntas 1/4"
5 ⚙- 3, 4, 5, 6, 7 mm.
4 ⚙- 3, 4, 5, 5, 7 mm. | 3 ⚙- PH0, PH1, PH2
3 ⚙- PZ0, PZ1, PZ2 | 9 ⚙- T6, T7, T8,
T9, T10, T15,
T20, T25, T30 |

COMPOSICIÓN VARIOS (34 piezas)

- | | | | |
|-------------------------------------|--|--------------------------------|---|
| 1 170165 Martillo peña
25 mm. | 8 170080 Llaves fijas
6x7 a 20x22 mm. | 1 170830 Flexómetro 3 m | 2 170518 Alicates universal 180 mm.
170555 Alicates corte diagonal 160 mm. |
| 1 170660 Llave ajustable
250 mm. | 1+3 170814 Cutter 18 mm. | 9 170610 Allen bola 1.5 a 10 m | 8 170450 Destornilladores
4 ⚙- 4x100, 5,5x125
6,5x150, 8x150 |
| | | | 2 ⚙- PH1x100
PH2x150 |
| | | | 2 ⚙- PZ1x100
PZ2x150 |



Panel abatible vista posterior



BOLSA ENROLLABLE CON HERRAMIENTAS



Cód.	Nº piezas	P.V.P. unid. €
196856	14	42,65

Características de la bolsa en pág. 84.

COMPOSICIÓN

- | | | |
|--|---------------------------|---|
| 1 170516 Alicates universal
160 mm. | 1 170830 Flexómetro
3M | 1 108025 Tijera multiusos
145 mm. |
| 1 170650 Llave ajustable
150 mm. | 1 170812 Cutter
9 mm. | 9 170457 Adaptador 1/4"
+8 puntas ⚙-⚙-⚙-⚙- |



1 KG



315xØ120 mm.
Medida enrollada





JUEGO DE HERRAMIENTA COMBINADA AISLADA

CERTIFICADO VDE

Cód.	Nº piezas	P.V.P. unid. €
101460	98	369,49

ACERO CR-V

72^{5º}
Dientes

9,8
KG



370x120x520 mm.



ESPECIAL ELECTRICISTAS



Carracas extensibles de 1/2" y 1/4"



Caja de plástico con bisagra central reforzada

COMPOSICIÓN AISLADA

- 1 101802 Alicata Universal 180 mm.
- 1 101821 Alicata corte diagonal 160 mm.
- 1 193369 Tester 1000 V
- 5 Destornilladores
 - 3 ⊖ Boca recta
 - 3x100 (119303)
 - 4x100 (119304)
 - 6,5x150 (119306)
 - 2 ⊕ PH1x100 (119311)
 - PH2x100 (119312)

COMPOSICIÓN 1/2"

- 17 Vasos 10 a 32 mm.
- 1 Carraca 1/2" extensible 72 dientes
- 2 Alargaderas 125, 250 mm.
- 1 Junta universal
- 1 Adap. puntas 5/16"
- 2 Llaves bujía 16 y 21 mm.
- 1 Adaptador 3/8"H x 1/2"M

COMPOSICIÓN 1/4"

- 13 Vasos 4 a 14 mm.
- 1 Carraca 1/4" extensible 72 dientes
- 2 Alargaderas 50, 150 mm.
- 1 Adaptador 3/8"H x 1/4"M
- 1 Atornillador 150 mm.
- 1 Junta universal

COMPOSICIÓN VARIOS

- 8 191080 Llaves fijas 6x7 a 20x22 mm.
- 9 193130 Allen bola 1,5 a 10 mm.
- 1 109103 Tenaza grip
- 1 108015 Tijera electricista
- 1 197315 Flexómetro 5M
- 25 Puntas 5/16"
- 1 196550 Martillo bola 455 grs.



JUEGO DE HERRAMIENTA COMBINADA

Cód.	Nº piezas	P.V.P. unid. €
101450	98	346,92

ACERO CR-V

72^{5º}
Dientes

9,8
KG



370x120x520 mm.



Carracas extensibles de 1/2" y 1/4"



Caja de plástico con bisagra central reforzada

COMPOSICIÓN NO AISLADA

- 1 101202 Alicata Universal 180 mm.
- 1 110302 Alicata corte diagonal 160 mm.
- 5 Destornilladores
 - 2 ⊖ Boca plana
 - 4x80 (119004)
 - 6,5x150 (119006)
 - 1 ⊖ Boca recta 3x100 (119023)
 - 2 ⊕ PH1x100 (119031)
 - PH2x150 (119032)

VARIOS

- 1 193369 Tester 1000 V

COMPOSICIÓN 1/2"

- 17 Vasos 10 a 32 mm.
- 1 Carraca 1/2" extensible 72 dientes
- 2 Alargaderas 125, 250 mm.
- 1 Junta universal
- 1 Adap. puntas 5/16"
- 2 Llaves bujía 16 y 21 mm.
- 1 Adaptador 3/8"H x 1/2"M

COMPOSICIÓN 1/4"

- 13 Vasos 4 a 14 mm.
- 1 Carraca 1/4" extensible 72 dientes
- 2 Alargaderas 50, 150 mm.
- 1 Adaptador 3/8"H x 1/4"M
- 1 Atornillador 150 mm.
- 1 Junta universal

COMPOSICIÓN VARIOS

- 8 191080 Llaves fijas 6x7 a 20x22 mm.
- 9 193130 Allen bola 1,5 a 10 mm.
- 1 109103 Tenaza grip
- 1 108015 Tijera electricista
- 1 197315 Flexómetro 5M.
- 25 Puntas 5/16"
- 1 196550 Martillo bola 455 grs.

01  **JUEGO DE HERRAMIENTA COMBINADA**



Cód.	Nº piezas	P.V.P. Unid. €
170742	113	229,63



540x400x110 mm.

COMPOSICIÓN 1/2"

- | | |
|----------------------------|-----------------------------|
| 16 Vasos 10 a 32 mm. | 1 Carraca 72 dientes |
| 2 Alargaderas 125, 250 mm. | 1 Adaptador 1/2" M x 3/8" H |

COMPOSICIÓN 1/4"

- | | |
|----------------------|-----------------------------|
| 10 Vasos 4 a 13 mm. | 1 Carraca 72 dientes |
| 1 Alargadera 100 mm. | 1 Adaptador 1/4" M x 3/8" H |

COMPOSICIÓN VARIOS

- | | | |
|---|---|---|
| 1 170518 Alicate universal 180 mm. | 1 170555 Alicate corte diagonal 160 mm. | 1 Atornillador 150 mm. |
| 9 170610 Llaves Allen bola 1.5 a 10 mm. | 1 170165 Martillo Peña 25 mm. | 1 170814 Cutter 18 mm. |
| 1 Adaptador de puntas 1/4" | 1 170660 Llave ajustable 250 mm. | 1 170960 Linterna |
| 12 Llaves combinadas 8 a 19 mm. | 1 170830 Flexómetro 3M. | 4 170449 Destornilladores
2 ⊖ 3x100, 5.5x125 2 ⊕ PH1x100, PH2x100 |
| 1 171055 Nivel torpedo | 1 170542 Tenacilla 250 mm. | 44 Puntas 1/4"
 |



Caja de plástico con bisagra central reforzada



Puntas especiales

 **BOLSA DE NYLON CON HERRAMIENTAS**



Cód.	Nº piezas	P.V.P. unid. €
171111	15	50,27

Características de la bolsa en pág. 84.

COMPOSICIÓN

- | | |
|------------------------------------|-------------------------|
| 1 170655 Llave ajustable 200 mm. | 1 170830 Flexómetro 3M. |
| 1 170518 Alicate universal 180 mm. | 1 108025 Tijera |
| 9 170457 Adaptador + 8 puntas 1/4" | 1 170955 Linterna |



Bolsa 171110



BOLSA DE NYLON CON HERRAMIENTAS AISLADAS

CERTIFICADO VDE

01

Cód.	Nº piezas	P.V.P. unid. €
101410	9	110,86

Características de la bolsa en pág. 84.

ESPECIAL
ELECTRICISTAS

COMPOSICIÓN AISLADA

1 101802 Alicates Universal 180 mm.	1 101821 Alicates corte diagonal 160 mm.
4 Destornilladores 2 Boca recta 4x100 (119304) 5'5x125 (119305)	2 PH1x100 (119311) PH2x100 (119312)

COMPOSICIÓN NO AISLADA

1 108015 Tijera electricista	1 108030 Navaja electricista
-------------------------------	-------------------------------



Bolsa 196880



BOLSA DE NYLON CON HERRAMIENTAS

Cód.	Nº piezas	P.V.P. unid. €
101400	9	86,49

Características de la bolsa en pág. 84.

COMPOSICIÓN

1 101202 Alicates Universal 180 mm.	1 110302 Alicates corte diagonal 160 mm.
1 108015 Tijera electricista	1 108030 Navaja electricista
4 Destornilladores 1 Boca plana 5,5x125 (119005)	1 Boca recta 4x100 (119024) 2 PH1x100 (119031) PH2x100 (119029)



Bolsa 196880

01



CAJA METÁLICA DE 5 BANDEJAS CON HERRAMIENTAS

Cód.	Nº piezas	P.V.P. unid. €
192736	76	426,37



























Características de la caja en pág. 68.

 Preparada para candado
 **28 KG** Carga máxima
 **14 KG**
 200x240x500 mm.



Caja 192736

COMPOSICIÓN

- | | | |
|--|--|---|
| 1  101202
Alicate Universal
180 mm. | 1  110302
Alicate corte diagonal
160 mm. | 1  101302
Alicate bocas semi redondas
200 mm. |
| 1  115100
Tenacilla canal
250 mm. | 1  109103
Tenaza grip bocas
curvas 235 mm. | 1  172252
Llave ajustable
250 mm. |
| 8  191080
Llaves fijas
6x7 a 20x22 mm. | 1  119100
Portapuntas 1/4" | 1  196523
Martillo peña 25 mm. |
| 1  196555
Martillo bola
680 grs. | 1  197512
Lima media caña
200 mm. | 9  193070
Llaves allen
1,5 a 10 mm. |
| 1  144004
Arco de sierra | 5  197260
Hoja de sierra
bimetálica | 1  106210
Seeger interiores recto
180 mm. |
| 1  197300
Flexómetro
3 metros | 1  106203
Seeger exteriores recto
180 mm. | 1  186618
Cutter 18 mm. |
| 1  196406
Espátula inox
60 mm. | 1  108015
Tijera multiusos | |
| 29  192195
Composición pág. 193 | 1  197455
Cortafíos 250 mm. | |
| 6  119050 Destornilladores:
2  \ominus 3x100 (119023)
4x100 (119024)
(rectos) | 2  \ominus 5,5x125 (119005)
6,5x150 (119006)
(planos) | 2  \oplus PH0x75 (119030)
PH1x100 (119031) |



CAJA METÁLICA DE 3 BANDEJAS CON HERRAMIENTAS

Cód.	Nº piezas	P.V.P. unid. €
192732	82	242,42

Características de la caja en pág. 69.

 Preparada para candado
 **18 KG** Carga máxima
 **8,4 KG**
 200x200x420 mm.



Caja 192732

COMPOSICIÓN

- | | | |
|---|--|--|
| 1  101202
Alicate universal
180 mm. | 1  110302
Alicate corte diagonal
160 mm. | 1  172251
Llave ajustable
200 mm. |
| 9  193070
Llaves allen 1,5 a
10 mm. | 1  108015
Tijera multiusos | 8  191080
Llaves fijas
6x7 a 20x22 mm. |
| 21  119115
Destornillador carraca +
vasos 1/4" + puntas 1/4" | 1  196406
Espátula inox
60 mm. | 1  197300
Flexómetro 3 metros |
| 32  193725
Puntas 1/4"
Ver composición pág. 169 | 1  119005
Destornillador
plano 5,5x125 mm. | 1  119032
Destornillador
PH2x150 mm. |
| 1  186618
Cutter 18 mm. | 1  144004
Arco de sierra | 1  196524
Martillo peña 30 mm. |





CAJA METÁLICA DE 5 BANDEJAS CON HERRAMIENTAS



01

Cód.	Nº piezas	P.V.P. unid. €
171131	68	196,86

Características de la caja en pág. 69.



Preparada para candado

25 KG

Carga máxima

**10 KG**

200x200x530 mm.



Caja 171130



COMPOSICIÓN

35 170735 Composición pág. 194	1 170518 Alicate universal 180 mm.	1 170555 Alicate corte diagonal 160 mm.
8 170080 Llaves fijas 6x7 a 20x22 mm.	1 170542 Tenacilla de canal 250 mm.	1 170840 Arco de sierra
9 170610 Llaves allen bola 1.5 a 10 mm.	1 170830 Flexómetro 3M	1 170814 Cutter 18 mm.
1 170152 Martillo bola 680 gr.	1 170660 Llave ajustable 250 mm.	1 171024 Nivel 400 mm.
1 170968 Linterna bifocal	5 170448 Destornilladores 3 3x75 (Recto) 4x100 (170404) 6.5x100 (170406) (Planos)	
	2 PH1x100 (170421) PH2x150 (170422)	



CAJA METÁLICA DE 3 BANDEJAS CON HERRAMIENTAS



Cód.	Nº piezas	P.V.P. unid. €
171136	65	154,10

Características de la caja en pág. 69.



Preparada para candado

15 KG

Carga máxima

**7 KG**

200x160x430 mm.



Caja 171135



COMPOSICIÓN

35 170735 Composición pág. 194	1 170518 Alicate universal 180 mm.	1 170555 Alicate corte diagonal 160 mm.
8 170080 Llaves fijas 6x7 a 20x22 mm.	1 170660 Llave ajustable 250 mm.	1 170160 Martillo Peña 20 mm.
9 170609 Llaves allen 1.5 a 10 mm.	1 170830 Flexómetro 3 M	1 170957 Linterna bifocal
1 170814 Cutter 18 mm.	5 170448 Destornilladores 3 3x75 (Recto) 4x100 (170404) 6.5x100 (170406) (Planos)	
	2 PH1x100 (170421) PH2x150 (170422)	



01 CAJA METÁLICA CON HERRAMIENTAS



Cód.	Nº piezas	P.V.P. unid. €
170781	60	125,72

Características de la caja en pág. 70.



Caja 170780

Preparada para candado
18 KG
 Carga máxima
 217x210x470 mm.

COMPOSICIÓN

- 8 170080 Llaves fijas 6x7 a 20x22 mm.
- 1 170518 Alicata universal 180 mm.
- 1 170814 Cutter 18 mm.
- 1 170555 Alicata corte diagonal 160 mm.
- 9 170609 Llaves allen 1.5 a 10 mm.
- 1 170830 Flexómetro 3M.
- 1 170160 Martillo Peña 20 mm.
- 1 170660 Llave ajustable 250 mm.
- 31 170490 Puntas 1/4" Ver composición en pág. 170
- 5 170448 Destornilladores
 - 2 ⊖ Boca plana 4x100 (170404)
 - 1 ⊖ Boca recta 3x75
 - 2 ⊕ PH1x100 (170421)
 - 2 ⊕ PH2x150 (170422)



CAJA DE PLÁSTICO CON HERRAMIENTAS



Cód.	Nº piezas	P.V.P. unid. €
170796	33	83,14

Características de la caja en pág. 74.



Caja 170795

5 KG
 Carga máxima
 215x195x420 mm.

COMPOSICIÓN

- 8 170080 Llaves fijas 6x7 a 20x22 mm.
- 1 170518 Alicata universal 160 mm.
- 1 170655 Llave ajustable 200 mm.
- 1 195625 Cutter 18 mm.
- 1 170830 Flexómetro 3M.
- 1 170955 Linterna
- 1 170160 Martillo Peña 20 mm.
- 1 170518 Alicata universal 160 mm.
- 9 170609 Llaves allen 1.5 a 10 mm.
- 9 170457 Adaptador + 8 puntas 1/4"



02

ALMACENAJE

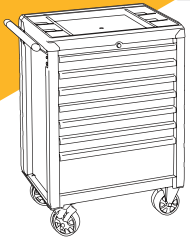

Carro metálico **39**

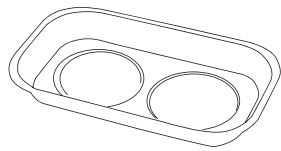

Accesorio carro **47**

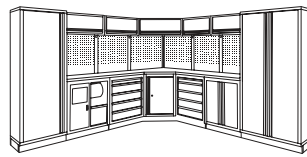

Conjunto de taller **50**

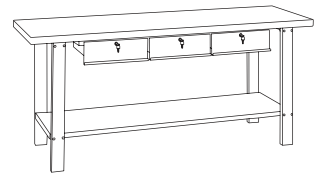

Mesa de trabajo **65**

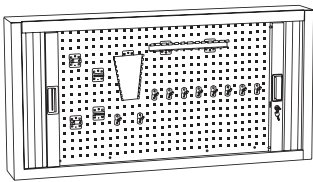

Armario panel **67**

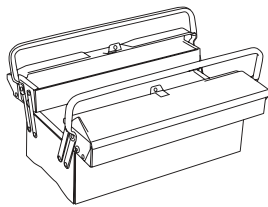

Caja metálica **68**

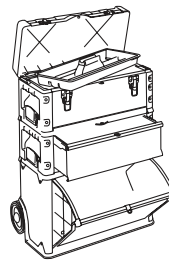

Carro modular **71**

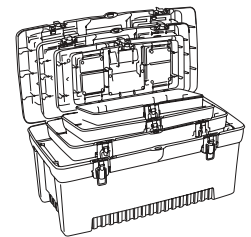

Caja de plástico **73**

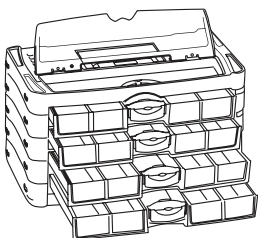

Organizador **74**

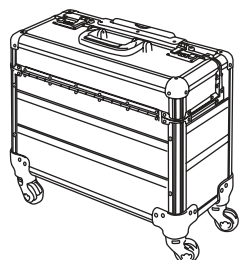

Maleta de aluminio **76**



Bolsa y trolley **81**

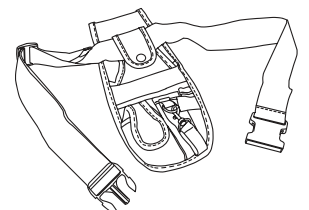

Bolsa de nylon **83**



CARRO METÁLICO REFORZADO DE 7 CAJONES

02

- Chapa de 1 mm de acero.
- Tratamiento anti-corrosión.
- Freno con posibilidad de bloqueo total en dos de las ruedas.
- Dos ruedas giratorias y dos fijas.
- Cierre de todos los cajones con cerradura centralizada.
- Tiradores de los cajones fabricados en aluminio.
- Rodamientos a bolas en las guías de los cajones.



Cerradura centralizada

400 KG



Carga máxima



Ruedas Ø 5" x 2"

Cajones	Medida mm	Peso admisible Kg
5 cajones	570x410x75	25
2 cajones	570x410x155	30



SISTEMA ANTIVUELCO
 Cuando hay un cajón abierto no se puede abrir ningún otro, para evitar el vuelco del carro.



Tras los desplazamientos, pisar el freno.



482x1013x722 mm.

ACCESORIOS INCLUIDOS



Asa reforzada



Bandeja metálica



Portadocumentos metálico



Bandeja Superior Acero Inoxidable



Soporte rollo papel



Papelera metálica



Cód.	P.V.P. unid. €	
192825	1.134,49	1



CARRO METÁLICO DE 7 CAJONES

- Chapa de 0,8 mm de acero.
- Tratamiento anti-corrosión.
- Bandeja superior en plástico moldeado con alojamientos.
- Freno con posibilidad de bloqueo total en dos de las ruedas.
- Dos ruedas giratorias y dos fijas.
- Cierre de todos los cajones con cerradura centralizada.
- Tiradores de los cajones fabricados en aluminio.
- Rodamientos a bolas en las guías de los cajones.



Cerradura centralizada

300 KG

Carga máxima



Ruedas Ø 5" x 2"

Cajones	Medida mm	Peso admisible Kg
6 cajones	570x410x75	20
1 cajón	570x410x155	30



SISTEMA ANTIVUELCO

Cuando hay un cajón abierto no se puede abrir ningún otro, para evitar el vuelco del carro.



Tras los desplazamientos, pisar el freno.

Cód.	P.V.P. unid. €	
129725	733,68	1



52 KG



480x980x700 mm.



CARRO METÁLICO DE 7 CAJONES

- Chapa de 0,8 mm de acero.
- Tratamiento anti-corrosión.
- Caucho protector en la bandeja superior y en la base de los cajones.
- Freno con posibilidad de bloqueo total en dos de las ruedas.
- Dos ruedas giratorias y dos fijas.
- Cierre de todos los cajones con cerradura centralizada.
- Tiradores de los cajones fabricados en aluminio.
- Rodamientos a bolas en las guías de los cajones.



Cerradura centralizada

300 KG

Carga máxima



Ruedas Ø 5" x 2"

Cajones	Medida mm	Peso admisible Kg
5 cajones	570x410x75	20
2 cajones	570x410x155	30



- Tras los desplazamientos, pisar el freno.
- No abrir dos cajones a la vez, por riesgo de vuelco.

Cód.	P.V.P. unid. €	
192710	707,95	1



59 KG



458x993x699 mm.

02



CARRO METÁLICO DE 8 CAJONES

- Chapa de 0,8 mm de acero.
- Tratamiento anti-corrosión.
- Caucho protector en la bandeja superior y en la base de los cajones.
- Freno con posibilidad de bloqueo total en dos de las ruedas.
- Dos ruedas giratorias y dos fijas.
- Cierre de todos los cajones con cerradura centralizada.
- Tiradores de los cajones fabricados en aluminio.
- Rodamientos a bolas en las guías de los cajones.



Cerradura centralizada

300 KG

Carga máxima



Ruedas Ø 5" x 2"

Cajones	Medida mm	Peso admisible Kg
7 cajones	570x410x75	20
1 cajón	570x410x155	30



- Tras los desplazamientos, pisar el freno.
- No abrir dos cajones a la vez, por riesgo de vuelco.

Cód.	P.V.P. unid. €	
129715	719,03	1



458x993x699 mm.



CARRO METÁLICO DE 5 CAJONES

- Chapa de 0,8 mm de acero.
- Tratamiento anti-corrosión.
- Caucho protector en la bandeja superior y en la base de los cajones.
- Freno con posibilidad de bloqueo total en dos de las ruedas.
- Dos ruedas giratorias y dos fijas.
- Cierre de todos los cajones con cerradura centralizada.
- Tiradores de los cajones fabricados en aluminio.
- Rodamientos a bolas en las guías de los cajones.



Cerradura centralizada

300 KG

Carga máxima



Ruedas Ø 5" x 2"

Cajones	Medida mm	Peso admisible Kg
2 cajones	570x410x75	20
2 cajones	570x410x155	30
1 cajón inferior	570x410x235	40



- Tras los desplazamientos, pisar el freno.
- No abrir dos cajones a la vez, por riesgo de vuelco.

Cód.	P.V.P. unid. €	
129720	674,08	1



458x993x699 mm.

**BANCO MÓVIL METÁLICO DE TRABAJO DE 10 CAJONES**

- Chapa de 0,8 mm de acero.
- Tratamiento anti-corrosión.
- Caucho protector en la bandeja superior y en la base de los cajones.
- Freno con posibilidad de bloqueo total en dos de las ruedas.
- Dos ruedas giratorias y dos fijas.
- Cierre de todos los cajones con cerradura centralizada.
- Tiradores de los cajones fabricados en aluminio.
- Rodamientos a bolas en las correderas de los cajones.



Cerradura centralizada

400 KG

Carga máxima



Ruedas Ø 5" x 2"

Cajones	Medida mm	Peso admisible Kg
1 Superior largo	937x406x122	30
2 4 cajones	570x406x 74	20
3 Inferior largo alto	570x406x311	30
4 2 cajones	313x406x 74	15
5 1 cajón	313x406x153	20
6 Inferior corto alto	313x406x311	25



- Tras los desplazamientos, pisar el freno.
- No abrir dos cajones a la vez, por riesgo de vuelco.

Cód.

P.V.P. unid. €

**192678****1.133,53**

1

**02****88 KG**

458x1007x1067 mm.

**CARRO METÁLICO ANCHO DE 7 CAJONES**

- Chapa de 0,8 mm de acero.
- Tratamiento anti-corrosión.
- Caucho protector en bandeja superior y en la base de los cajones.
- Freno con posibilidad de bloqueo total en dos de las ruedas.
- Dos ruedas giratorias y dos fijas.
- Cierre de todos los cajones con cerradura centralizada.
- Tiradores de los cajones fabricados en aluminio.
- Rodamientos a bolas en las correderas de los cajones.



Cerradura centralizada

350 KG

Carga máxima



Ruedas Ø 5" x 2"

Cajones	Medida mm	Peso admisible Kg
5 cajones	821x410x75	20
2 cajones	821x410x155	30



- Tras los desplazamientos, pisar el freno.
- No abrir dos cajones a la vez, por riesgo de vuelco.

Cód.

P.V.P. unid. €

**192815****826,52**

1

**69 KG**

458x993x914 mm.



CARRO METÁLICO DE 6 CAJONES



02

- Chapa de 0,8 mm de acero.
- Tratamiento anti-corrosión.
- Caucho protector en la bandeja superior y en la base de los cajones.
- Freno con posibilidad de bloqueo total en dos de las ruedas.
- Dos ruedas giratorias y dos fijas.
- Cierre de todos los cajones con cerradura centralizada.
- Rodamientos a bolas en las guías de los cajones.



Cerradura centralizada

250 KG

Carga máxima



Ruedas Ø 5" x 2"

Cajones	Medida mm	Peso admisible Kg
3 cajones	568x398x75	25
3 cajones	568x398x154	25



- Tras los desplazamientos, pisar el freno.
- No abrir dos cajones a la vez, por riesgo de vuelco.

Cód.	P.V.P. unid. €	
170860	648,84	1



CARRO METÁLICO DE 2 CAJONES Y PORTÓN



- Chapa de 0,8 mm de acero.
- Tratamiento anti-corrosión.
- Caucho protector en la bandeja superior y en la base de los cajones.
- Freno con posibilidad de bloqueo total en dos de las ruedas.
- Dos ruedas giratorias y dos fijas.
- Cierre de todos los cajones con cerradura centralizada.
- Rodamientos a bolas en las guías de los cajones.
- Cerradura independiente en portón.



Cerradura centralizada

200 KG

Carga máxima



Ruedas Ø 5" x 2"

Cajones	Medida mm	Peso admisible Kg
1 cajón	568x398x75	25
1 cajón	568x398x154	25
1 Arcón inferior	568x398x330	25



- Tras los desplazamientos, pisar el freno.
- No abrir dos cajones a la vez, por riesgo de vuelco.

Cód.	P.V.P. unid. €	
170871	505,70	1





ARCÓN METÁLICO DE 3 CAJONES

- Tapa plegable para cierre y protección de cajones.
- Con sistema de apertura con muelles de gas.
- Caucho protector en la bandeja superior de 10 mm.
- Caucho protector en la base de los cajones.
- Asas laterales abatibles.
- Combinable con los carros cód. 192710, 129715 y 129720.



Cerradura centralizada

90 KG

Carga máxima



445x584x684 mm.

Cajones	Medida mm	Peso admisible Kg
3 cajones	560x393x59	5

Cód.	Descripción	P.V.P. unid. €	
129705	ARCÓN	439,17	1
129706	ARCÓN + CARRO 192710	1.143,83	1



129705



129706



ARCÓN METÁLICO DE 3 CAJONES

- Chapa de Acero de 0,8 mm.
- Cajones con guías con rodamiento a bolas.
- Caucho protector en la bandeja superior de 10 mm.
- Cierre centralizado de cajones con 2 llaves.
- Asas laterales abatibles.
- Combinable con los carros cód. 170860 y 170871.



Cerradura centralizada

75 KG

Carga máxima



170875



170876



170878

Cajones	Medida mm	Peso admisible Kg
2 cajones	568x398x50	20
1 cajón	568x398x75	20



- Tras los desplazamientos, pisar el freno.
- No abrir dos cajones a la vez, por riesgo de vuelco.

Cód.	Descripción	P.V.P. unid. €	
170875	ARCÓN	232,24	1
170876	ARCÓN + CARRO 170860	865,93	1
170878	ARCÓN + CARRO 170871	737,94	1



440x270x670 mm.



170876
CONJUNTO
170875 + 170860



170878
CONJUNTO
170875 + 170871



460x1290x680 mm.



460x1130x680 mm.

CARRO DE TALLER LIGERO DE 2 CAJONES CON APERTURA SUPERIOR

02

- Tapas superiores correderas.
- Caucho protector en ambas tapas superiores.
- Cerradura con llave para cajones y tapa.
- Guías de los cajones con rodamientos a bolas.
- Freno con posibilidad de bloqueo en dos de las ruedas.
- Dos ruedas fijas y dos giratorias.
- Pilares de sujeción en forma de L, sujetos por el exterior del armazón para un máximo aprovechamiento del espacio de la bandeja inferior.



Con la cerradura en posición cerrada las tapas superiores correderas no pueden abrirse.



Cerradura centralizada

150 KG

Carga máxima



Ruedas Ø 4" x 1"



Instrucciones de MONTAJE

Cajones	Medida mm	Peso admisible Kg
Bandeja superior	700x365x170	35
2 cajones	587x325x60	10
Bandeja inferior	700x365x85	35



- Tras los desplazamientos, pisar el freno.
- No abrir dos cajones a la vez, por riesgo de vuelco.

Cód.	P.V.P. unid. €	
192780	363,48	1

Se suministra desmontado.

Medida caja: 790x440x430 mm.



370x836x705 mm.



CARRO DE TALLER DE 2 BANDEJAS REFORZADO

- Estructura reforzada y fina para un fácil manejo.
- Caucho protector en toda la superficie de las dos bandejas.
- Freno con posibilidad de bloqueo en dos de las ruedas.
- Dos ruedas giratorias y dos fijas.
- Asa lateral reforzada.
- Pilares de sujeción en forma de L, colocados por el exterior de las bandejas para un máximo aprovechamiento de las mismas.
- Superficie de las dos bandejas: 882x488mm.
- Peso admisible por bandeja: 50kgs.

200 KG

Carga máxima



Ruedas Ø 5" x 2"



Instrucciones de MONTAJE



Tras los desplazamientos, pisar el freno.

Cód.	P.V.P. unid. €	
192832	346,29	1

Se suministra desmontado.

Medida caja: 950x560x220 mm.



500x870x980 mm.



CARRO DE TALLER LIGERO DE 1 CAJÓN Y 2 BANDEJAS

- Cajón con guías a rodamiento de bolas.
- Freno con posibilidad de bloqueo en dos de las ruedas.
- Dos ruedas giratorias y dos fijas.
- Asa lateral reforzada.



Cerradura centralizada

140 KG

Carga máxima



Ruedas Ø 4" x 1,5"



Instrucciones de MONTAJE

Cajones	Medida mm	Peso admisible Kg
1 Cajón	737x383x60	10
2 Bandejas	737x383x85	35



Tras los desplazamientos, pisar el freno.

Cód.	P.V.P. unid. €	
192727	331,76	1

Se suministra desmontado.



Medida caja: 800x435x375 mm.



383x727x737 mm.

02



CARRO DE TALLER DE 3 BANDEJAS

- Asa para fácil manejo del carro.
- Freno con posibilidad de bloqueo en dos de las ruedas.
- Dos ruedas giratorias y dos fijas.

100 KG

Carga máxima



Ruedas Ø 4" x 1"



Instrucciones de MONTAJE

Cajones	Medida mm	Peso admisible Kg
3 Bandejas	719x365x85	35



Tras los desplazamientos, pisar el freno.

Cód.	P.V.P. unid. €	
192725	178,25	1

Se suministra desmontado.



Medida caja: 780x420x160 mm.



365x663x719 mm.



DIVISOR PARA CAJONES

- Separadores metálicos. Chapa 1 mm.

POSIBILIDADES DE DIVISORES		
Cód.	Para carro	Piezas
192699	192825 / 129725	4 chapas 565x40 mm
	129705 / 192710	6 chapas 403x40 mm
	129715 / 129720	
192604	192815	4 chapas 565x40 mm 9 chapas 780x40 mm

Cód.	Nº Piezas	P.V.P. unid. €	
192699	10	27,47	1
192604	13	35,55	1



192604



192699



GUÍAS PARA CAJONES

- Guías de rodamientos a bolas.
- Medidas: 400x45mm.
- 1 unidad contiene: 1 guía derecha + 1 guía izquierda.



Cód.	Para códigos	P.V.P. unid. €	
190609	192854, 192859, 192860 192861, 192876, 192878	20,00	1
190610	129715, 129720, 129725 192678, 192710, 192815	20,00	1
170867	170860, 170871	19,19	1

Precio por par de guías.



RUEDAS PARA CARROS

- Estructura metálica.
- Ruedas de poliuretano.
- Incluidos 4 tornillos para montaje.
- Con rodamientos de agujas.

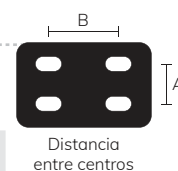

Cód.	Tipo	Ø" x Ancho"	Para códigos	Amm Bmm	P.V.P. unid. €	
190620	Fija	4x1	192780	Espárrago M9	14,62	1
190621	Móvil con freno	4x1	192780	Espárrago M9	22,09	1
190622	Fija reforzada	5x2	129715, 129720, 129725, 192678 192710, 192815, 192825, 192832	70 85	25,58	1
190623	Móvil con freno y reforzada	5x2	129715, 129720, 129725, 192678 192710, 192815, 192825, 192832	70 85	36,05	1
190624	Fija	5x2	170860, 170871	43 75	14,61	1
190625	Móvil con freno	5x2	170860, 170871	43 75	22,10	1
190626	Fija	4x1	192725	43 75	14,61	1
190627	Móvil con freno	4x1	192725	43 75	22,09	1
190628	Fija	4x1,5	192727	43 75	22,77	1
190629	Móvil con freno	4x1,5	192727	43 75	27,63	1



CERRADURA CON LLAVES PARA CARROS, ARMARIOS Y MESAS DE TRABAJO

- Cerradura metálica fácilmente montable. Conjunto de 2 llaves y bombín.

Cód.	Para Códigos	P.V.P. unid. €	
170866	Carros: 170860, 170871	5,28	1
190611	Carrito: 192727	8,52	1
190612	Carro: 192780	8,52	1
190614	Módulos con puertas: 192851, 192852, 192855, 192856, 192875	8,52	1
190615	Carros: 192825, 129725, 192678, 192710, 192815, 129715, 129720	9,24	1
190616	Mesas de trabajo: 129750, 129755	8,52	1
190617	Mesas de trabajo: 192675, 192676, 192677	8,53	1
190618	Arcón: 129705	8,52	1
190619	Módulos con armarios: 192854, 192859, 192860, 192861, 192876, 192878	8,29	1





PLATO MAGNÉTICO RECTANGULAR

ACERO
INOX1000
gauss

- Medida 237x163 mm.
- Profundidad plato 28 mm.
- 2 bases magnéticas Ø 80 mm.
- Base de PVC para evitar rayado.



02



Cód. P.V.P. unid. €

121510 **9,75** 1

Se suministra en blíster.



PLATO MAGNÉTICO REDONDO

ACERO
INOX1000
gauss

- Diámetro del plato 150 mm.
- Profundidad plato 25 mm.
- Ø Imán 80 mm.
- Base de PVC para evitar rayado.



Cód. P.V.P. unid. €

121500 **5,26** 1

Se suministra en blíster.



PLATO MAGNÉTICO PROFUNDO

800
gauss

- Recipiente de plástico.
- Diámetro exterior 109 mm.
- Profundidad plato 78 mm.
- Ø Imán 60 mm.
- Base de PVC para evitar rayado.



Cód. P.V.P. unid. €

121502 **5,58** 1

02



BANDEJA MAGNÉTICA



- Bandeja metálica de 310x110x120mm.
- 4 imanes de alta potencia.
- Capacidad de carga 1,20 kg.



Cód.	P.V.P. unid. €	
121560	10,23	1



SOPORTE MAGNÉTICO PARA SPRAYS Y DESTORNILLADORES



- Bandeja metálica de 119x300x126 mm.
- 8 imanes de alta potencia.
- Orificios para 7 destornilladores.
- Espacio para 3 sprays de Ø 76 mm.
- Capacidad de carga 1,20 kg.



Cód.	P.V.P. unid. €	
121566	16,78	1



SOPORTE MAGNÉTICO PARA DESTORNILLADORES



- Soporte metálico de 240x48x28 mm.
- 3 imanes de alta potencia.
- Orificios para 9 destornilladores.



Cód.	P.V.P. unid. €	
121562	8,06	1



SOPORTE MAGNÉTICO PARA LLAVES



- Soporte metálico: 229x150(65)x24mm.
- Imán en la parte posterior.
- Orificios para colgar.
- Para uso con llaves desde 6 a 24mm.



Cód.	P.V.P. unid. €	
121564	7,32	1



SOPORTE MAGNÉTICO PARA ROLLOS DE PAPEL



- Par de soportes metálicos.
- Dimensiones: 102x130x83mm.
- Capacidad de 0,64kg.



Cód.	P.V.P. unid. €	
121568	11,94	1



GANCHO MAGNÉTICO GRANDE



- Soporte magnético con gancho atornillado.
- Ø 64 mm.
- Capacidad de carga 11kg.



Cód.	P.V.P. unid. €	
121572	3,48	1

Se suministra en blíster.



JUEGO DE 2 GANCHOS MAGNÉTICOS



- Soporte magnético con gancho atornillado.
- Ø 36 mm.
- Capacidad de carga 6kg. cada gancho.



Cód.	P.V.P. unid. €	
121570	2,96	1

Se suministra en blíster con 2 ganchos.



SOPORTE MAGNÉTICO



- Con agujero en cada extremo para sujeción.
- Tornillos incluidos.
- Para organizar, sujetar y exponer todo tipo de herramientas.

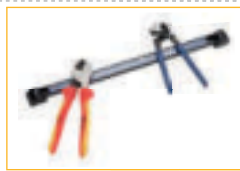

Cód.	L mm	Carga Kg	P.V.P. unid. €	
121518	450	13	9,65	1
121524	600	17	11,51	1

Se suministra en blíster.



Accesorio para unir soportes magnéticos (se incluyen 2 en 121518).



BANDA MAGNÉTICA PARA MUÑECA



- Banda regulable con velcro.
- Imán de 45x22mm.
- Útil para pequeñas herramientas, clavos, tuercas, tornillos...



Cód.	P.V.P. unid. €	
121535	3,17	1

Se suministra en blíster.



CONJUNTO DE TALLER DE 7 MÓDULOS

02



CARACTERÍSTICAS

- Espesor de chapa 0,8 mm.
- Sistema modular innovador adaptable a sus necesidades.
- Montaje rápido y sencillo.
- Posibilidad de combinaciones sin límite.
- Posibilidad de superficie de trabajo en madera y acero inoxidable.
- Los componentes se pueden vender separadamente.

COMPOSICIÓN

- 1 armario alto 192852
- 1 armario alto 192851
- 1 conjunto esquinero 192841 ó 192837
- 4 armarios superiores 192848
- 1 armario base multifunción 192858
- 2 armarios base de 5 cajones 192854
- 1 armario base de 2 puertas 192856
- 4 paneles perforados 192846
- 2 bases de trabajo 192863 ó 192873
- 14 pilares de unión 192864.



INSTRUCCIONES DE MONTAJE



VIDEO DE MONTAJE



BANDEJAS DE ESPUMA CON HERRAMIENTAS PARA CAJONES, DISPONIBLES EN PÁGINAS 23 A 28





COMPLEMENTOS

- Baldas para armarios cód. 192851 / 192852 / 192856 (ver págs. 59 y 63).
- Ganchos para paneles perforados cód. 192846 (ver pág. 64).
- Accesorios magnéticos (ver págs. 47 a 49).
- Cerraduras y llaves para cód. 192851 / 192852 / 192854 / 192856 (ver pág. 46).
- Guías para cajones para cód. 192854 (ver pág. 46).

DIMENSIONES

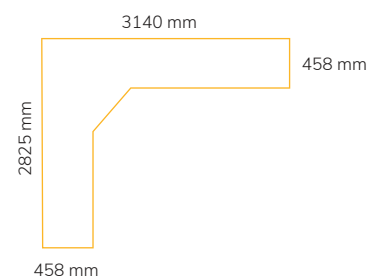

BASES DE TRABAJO DISPONIBLES

Madera



Acero Inox



Cód.	Material base	P.V.P. unid. €
192839	Madera	6.552,93
192838	Acero Inox.	6.727,41



192839



192838



CONJUNTO DE TALLER DE 4 MÓDULOS

02

- Espesor de chapa 0,8 mm.
- Sistema modular innovador adaptable a sus necesidades.
- Montaje rápido y sencillo.
- Posibilidad de combinaciones sin límite.
- Posibilidad de superficie de trabajo en madera y acero inoxidable.
- Los componentes se pueden vender separadamente.



192843



INSTRUCCIONES DE MONTAJE



192842

BANDEJAS DE ESPUMA CON HERRAMIENTAS PARA CAJONES, DISPONIBLES EN PÁGINAS 23 A 28

COMPOSICIÓN

- 1 armario alto 192852.
- 3 armarios superiores 192848.
- 1 armario base multifunción 192858.
- 1 armario base de 5 cajones 192854.
- 1 armario base de 2 puertas 192856.
- 3 paneles perforados 192846.
- 1 base de trabajo 192862 ó 192872.
- 7 pilares de unión 192864.

COMPLEMENTOS

- Baldas para armarios cód. 192852 / 192856 (ver págs. 59 y 63).
- Ganchos para paneles perforados cód. 192846 (ver pág. 64).
- Accesorios magnéticos (ver págs. 47 a 49).
- Cerraduras y llaves para cód. 192852 / 192854 / 192856 (ver pág. 46).
- Guías para cajones para cód. 192854 (ver pág. 46).

BASES DE TRABAJO DISPONIBLES

Madera



Acero Inox



458x2000x2955 mm.



192842



192843

Cód.	Material base	P.V.P. unid. €
192842	Madera	3.741,10
192843	Acero Inox.	3.820,11



CONJUNTO DE TALLER DE 3 MÓDULOS

- Espesor de chapa 0,8 mm.
- Sistema modular innovador adaptable a sus necesidades.
- Montaje rápido y sencillo.
- Posibilidad de combinaciones sin límite.
- Posibilidad de superficie de trabajo en madera y acero inoxidable.
- Los componentes se pueden vender separadamente.



INSTRUCCIONES DE MONTAJE



192844

02



192845

BANDEJAS DE ESPUMA CON HERRAMIENTAS PARA CAJONES,
DISPONIBLES EN PÁGINAS 23 A 28

COMPOSICIÓN

- 1 armario alto 192852.
- 2 armarios superiores 192848.
- 1 armario base de 5 cajones 192854.
- 1 armario base de 2 puertas 192856.
- 2 paneles perforados 192846.
- 1 base de trabajo 192863 ó 192873.
- 5 pilares de unión 192864.

COMPLEMENTOS

- Baldas para armarios cód. 192852 / 192856 (ver págs. 59 y 63).
- Ganchos para paneles perforados cód. 192846 (ver pág. 64).
- Accesorios magnéticos (ver págs. 47 a 49).
- Cerraduras y llaves para cód. 192852 / 192854 / 192856 (ver pág. 46).
- Guías para cajones para cód. 192854 (ver pág. 46).

BASES DE TRABAJO DISPONIBLES

Madera



Acero Inox

458x2000x2275
mm.

192844



192845

Cód.	Material base	P.V.P. unid. €
192844	Madera	2.661,40
192845	Acero Inox.	2.725,43



CONJUNTO DE TALLER DE 4 MÓDULOS CON CARRO ANCHO DE 7 CAJONES

02

- Espesor de chapa 0,8 mm.
- Sistema modular innovador adaptable a sus necesidades.
- Montaje rápido y sencillo.
- Posibilidad de combinaciones sin límite.
- Posibilidad de superficie de trabajo en madera y acero inoxidable.
- Los componentes se pueden vender separadamente.



129805



INSTRUCCIONES DE MONTAJE



129800

COMPOSICIÓN

- 1 armario alto 192851.
- 1 armario superior 192848.
- 1 armario base de 2 puertas 192856.
- 1 carro ancho 7 cajones con ruedas 192876.
- 3 paneles perforados 192846.
- 1 armario superior ancho 192877.
- 1 mesa de trabajo 192665.
- 1 base de trabajo 192862 ó 192872.
- 7 pilares de unión 192864.

COMPLEMENTOS

- Baldas para armarios cód. 192851 / 192856 (ver págs. 59 y 63).
- Ganchos para paneles perforados cód. 192846 (ver pág. 64).
- Accesorios magnéticos (ver págs. 47 a 49).
- Cerraduras y llaves para cód. 192851 / 192856 / 192876 (ver pág. 46).
- Guías para cajones para cód. 192876 (ver pág. 46).

BASES DE TRABAJO DISPONIBLES

Madera



Acero Inox



458x2000x2640 mm.

Cód.	Material base	P.V.P. unid. €
129800	Madera	3.152,37
129805	Acero Inox.	3.231,38



129800



129805



CONJUNTO DE TALLER DE 4 MÓDULOS CON BANCO FIJO DE TRABAJO

- Espesor de chapa 0,8 mm.
- Sistema modular innovador adaptable a sus necesidades.
- Montaje rápido y sencillo.
- Posibilidad de combinaciones sin límite.
- Posibilidad de superficie de trabajo en madera y acero inoxidable.
- Los componentes se pueden vender separadamente.



INSTRUCCIONES
DE MONTAJE



129810

02



129815

COMPOSICIÓN

- 1 armario alto 192851.
- 1 armario superior 192848.
- 1 armario base de 2 puertas 192856.
- 1 banco fijo de trabajo 192878.
- 3 paneles perforados 192846.
- 1 armario superior ancho 192877.
- 1 base de trabajo 192862 ó 192872.
- 7 pilares de unión 192864.

COMPLEMENTOS

- Baldas para armarios cód. 192851 / 192856 (ver págs. 59 y 63).
- Ganchos para paneles perforados cód. 192846 (ver pág. 64).
- Accesorios magnéticos (ver págs. 47 a 49).
- Cerraduras y llaves para cód. 192851 / 192856 / 192878 (ver pág. 46).
- Guías para cajones para cód. 192878 (ver pág. 46).

BASES DE TRABAJO DISPONIBLES

Madera



Acero Inox



458x2000x2640
mm.

Cód.	Material base	P.V.P. unid. €
129810	Madera	3.243,01
129815	Acero Inox.	3.321,83



129810



129815



CONJUNTO DE TALLER DE 3 MÓDULOS CON MÓDULO DE GRIFO

02

COMPOSICIÓN

- 1 armario alto 192852.
- 2 armarios superiores 192848.
- 1 armario base de 9 cajones 192860.
- 1 armario base con 2 puertas y grifo 192855.
- 2 paneles perforados 192846.
- 1 base de trabajo 192867 ó 192871.
- 5 pilares de unión 192864.

COMPLEMENTOS

- Baldas para armarios cód. 192852 (ver pág. 63).
- Ganchos para paneles perforados cód. 192846 (ver pág. 64).
- Accesorios magnéticos (ver págs. 47 a 49).
- Cerraduras y llaves para cód. 192852 / 192855 / 192860 (ver pág 46).
- Guías para cajones para cód. 192860 (ver pág 46).

BANDEJAS DE ESPUMA CON HERRAMIENTAS PARA CAJONES, DISPONIBLES EN PÁGINAS 23 A 28



129820



129825



458x2000x2275 mm.



INSTRUCCIONES DE MONTAJE



129820



129825

Cód.	Material base	P.V.P. unid. €
129820	Madera	3.047,21
129825	Acero Inox.	3.108,75



CONJUNTO DE TALLER DE 3 MÓDULOS CON CARRO DE 5 CAJONES

COMPOSICIÓN

- 1 armario alto 192852.
- 2 armarios superiores 192848.
- 1 base de 5 cajones con ruedas 192861.
- 2 soportes triangulares para hueco vacío 192866.
- 1 armario base de 2 puertas 192856.
- 2 paneles perforados 192846.
- 1 base de trabajo 192863 ó 192873.
- 5 pilares de unión 192864

COMPLEMENTOS

- Baldas para armarios cód. 192852 / 192856 (ver págs. 59 y 63).
- Ganchos para paneles perforados cód. 192846 (ver pág. 64).
- Accesorios magnéticos (ver págs. 47 a 49).
- Cerraduras y llaves para cód. 192852 / 192856 / 192861 (ver pág 46).
- Guías para cajones para cód. 192861 (ver pág 46).



458x2000x2275 mm.



INSTRUCCIONES DE MONTAJE



129835



129830



129830



129835

Cód.	Material base	P.V.P. unid. €
129830	Madera	2.536,86
129835	Acero Inox.	2.601,76



CONJUNTO DE TALLER DE 2 MÓDULOS CON MÓDULO DE 7 CAJONES

COMPOSICIÓN

- 1 armario alto 192852.
- 1 armario superior 2 puertas 192875.
- 1 base de 7 cajones 192859.
- 1 panel perforado 192846.
- 1 base de trabajo 192867 ó 192871.
- 3 pilares de unión 192864.

COMPLEMENTOS

- Baldas para armarios cód. 192852 (ver pág. 63).
- Ganchos para paneles perforados cód. 192846 (ver pág. 64).
- Accesorios magnéticos (ver págs. 47 a 49).
- Cerraduras y llaves para cód. 192852 / 192859 (ver pág 46).
- Guías para cajones para cód. 192859 (ver pág 46).

BANDEJAS DE ESPUMA CON HERRAMIENTAS PARA CAJONES, DISPONIBLES EN PÁGINAS 23 A 28



129840



129845

Cód.	Material base	P.V.P. unid. €
129840	Madera	1.801,79
129845	Acero Inox.	1.863,36



129840



129845

INSTRUCCIONES
DE MONTAJE458x2000x1595
mm.

02



CONJUNTO DE TALLER DE 1 MÓDULO DE 5 CAJONES

COMPOSICIÓN

- 1 armario superior 192848.
- 1 base de 5 cajones 192854.
- 1 panel perforado 192846.
- 1 base de trabajo 192867 ó 192871.
- 2 pilares de unión 192864

COMPLEMENTOS

- Ganchos para panel perforado cód. 192846 (ver pág. 64).
- Accesorios magnéticos (ver págs. 47 a 49).
- Cerraduras y llaves para cód. 192854 (ver pág 46).
- Guías para cajones para cód. 192854 (ver pág 46).

BANDEJAS DE ESPUMA CON HERRAMIENTAS PARA CAJONES, DISPONIBLES EN PÁGINAS 23 A 28



129850



129855

Cód.	Material base	P.V.P. unid. €
129850	Madera	969,65
129855	Acero Inox.	1.031,19



129850



129855

INSTRUCCIONES
DE MONTAJE458x2000x680
mm.



CONJUNTO ARMARIO ALTO DOBLE Y ESTANTERÍA SIMPLE

02 COMPOSICIÓN

- 1 armario alto doble 192852.
- 1 estantería simple 192881.

COMPLEMENTOS

- Baldas de armario cód 192852 (ver pág. 63).
- Ganchos para panel perforado de estantería cód. 192881 (ver pág. 64).



INSTRUCCIONES DE MONTAJE

Cód.	P.V.P. unid. €
129860	1.392,92



458x2000x1595 mm.



ESTANTERÍA

- Estructura de acero de 1,5 mm.
- Baldas de acero de 0,6 mm.
- Panel perforado de acero de 0,7 mm.
- Capacidad de carga 50 kgs/bandeja.
- Agujeros del panel 10x10 mm.
- Ganchos del pack 113499 compatible con 192881/192886 (ver pág. 64).

Cód.	Medida mm	P.V.P. unid. €
192881	680x458x2000	346,50
192886	1200x458x2000	456,79



192881



192886

Se suministran desmontadas.

200 KG

Carga máxima



458x2000x680 mm.

Medida caja: 500x2040x165 mm.



192881



INSTRUCCIONES DE MONTAJE



192886

200 KG

Carga máxima



458x2000x1200 mm.

Medida caja: 500x2040x165 mm.



ARMARIO BASE DE 5 CAJONES



Cerradura centralizada

- Estructura en acero de 1 mm y cajones de 0,8 mm.
- 5 cajones con guías de rodamiento a bolas.
- 1 cajón de 568x403x75 mm.
- 4 cajones de 568x403x154 mm.
- Bandejas de espuma con herramientas para cajones, disponibles en páginas 23 a 28.



Cód.	Material base	P.V.P. unid. €
192854	Sin Encimera	614,33
129862	Madera	709,02
129864	Acero Inox.	770,55



192854



129862



129864



ARMARIO BASE DE 7 CAJONES



Cerradura centralizada

- Estructura en acero de 1 mm y cajones de 0,8 mm.
- 7 cajones con guías de rodamiento a bolas.
- 5 cajones de 568x403x75 mm.
- 2 cajones de 568x403x154 mm.
- Bandejas de espuma con herramientas para cajones, disponibles en páginas 23 a 28.



Cód.	Material base	P.V.P. unid. €
192859	Sin Encimera	655,38
129866	Madera	750,07
129868	Acero Inox.	811,61



192859



129866



129868



ARMARIO BASE DE 9 CAJONES



Cerradura centralizada

- Estructura en acero de 1 mm y cajones de 0,8 mm.
- 9 cajones con guías de rodamiento a bolas de 568x403x75 mm.
- Bandejas de espuma con herramientas para cajones, disponibles en páginas 23 a 28.



Cód.	Material base	P.V.P. unid. €
192860	Sin Encimera	730,19
129870	Madera	824,88
129872	Acero Inox.	886,42



192860



129870



129872



ARMARIO BASE DE 2 PUERTAS



Cerradura centralizada

- Estructura en acero de 1 mm y puertas de 0,8 mm.
- Medida interior 678x430x769 mm.
- Incluye una balda interior cód. 192857.



Cód.	Material base	P.V.P. unid. €
192856	Sin Encimera	364,97
129874	Madera	459,65
129876	Acero Inox.	521,18
192857	Balda interior	39,85



192856



129874



129876



192857

02



ARMARIO BASE MULTIFUNCIÓN

- Estructura en acero de 1 mm y puertas de 0,8 mm.
- Con trampilla para cubo de basura de 358x433x769 mm.
- Con soporte para rollo de papel de 250x433x360 mm.
- 1 cajón de 250x403x295 mm.



458x910x680 mm.



192858



129878



129880

Cód.	Material base	P.V.P. unid. €
192858	Sin Encimera	496,69
129878	Madera	591,39
129880	Acero Inox.	652,92



ARMARIO CON 2 PUERTAS Y GRIFO

- Estructura en acero de 1 mm y puertas de 0,8 mm.
- Fregadera y grifo fabricados en Acero Inoxidable.
- Se suministra con todos los elementos de instalación de fontanería.
- Incluye jabonera en un lateral (con botella).



SOLO DISPONIBLE CON ENCIMERA DE ACERO INOX.



Cerradura centralizada



458x948x680 mm.

Cód.	P.V.P. unid. €
192855	875,26



CARRO DE 5 CAJONES



Cerradura centralizada

- Estructura en acero de 1 mm y cajones de 0,8 mm.
- Chapa de acero de 0,8 mm
- 5 cajones con guías de rodamiento a bolas.
- 2 cajones de 534x403x75 mm
- 3 cajones de 534x403x153 mm.
- Incluye dos ruedas fijas y dos giratorias con freno.
- Asas en la parte superior para poder extraer el carro.
- Bandejas de espuma con herramientas para cajones, disponibles en páginas 23 a 28.



458x861x646 mm

Cód.	P.V.P. unid. €
192861	595,80



Para situar este carro debajo de una encimera es indispensable utilizar dos soportes triangulares Cód. 192866 (ver abajo).



SOPORTE TRIANGULAR PARA HUECO VACÍO

- Estructura de acero con forma de escuadra que debe atornillarse a los dos módulos entre los que se quiera dejar un hueco vacío.



Cód.	P.V.P. unid. €
192866	67,45

Precio del par de soportes.

IMPRESINDIBLE SI SE QUIEREN INCLUIR LOS CARROS 192861 Ó 192876 DENTRO DE UN CONJUNTO MODULAR.



Medidas: 458x310mm.



BANCO FIJO DE TRABAJO



Cerradura centralizada

- Estructura en acero de 1 mm y cajones de 0,8 mm.
- Cajones con guías de rodamiento a bolas.
- 1 cajón de 1248x403x78 mm.
- 5 cajones de 783x403x58 mm.
- 1 cajón de 783x403x137 mm.
- Incluye bandeja para compartimento interior.



129886



129888



192878



450x910x1360 mm.



192878



129886



129888

Cód.	Material base	P.V.P. unid. €
192878	Sin Encimera	1.120,48
129886	Madera	1.356,09
129888	Acero Inox.	1.419,77



CARRO ANCHO DE 7 CAJONES



Cerradura centralizada

- Estructura en acero de 1 mm y cajones de 0,8 mm.
- Cajones con guías de rodamiento a bolas.
- 6 cajones de 783x403x58 mm.
- 1 cajón de 783x403x137 mm.
- Incluye dos ruedas fijas y dos giratorias con freno.
- Asas en la parte superior para poder extraer el carro.



Para situar este carro debajo de una encimera es indispensable utilizar dos soportes triangulares Cód. 192866 (ver página anterior).



458x731x895 mm.

Cód.	P.V.P. unid. €
192876	809,92



MESA DE TRABAJO

- Patas en acero de 2 mm y resto de la estructura de 1,5 mm.
- Incluye 4 patas de nivelación que permiten regular la altura de la mesa entre 875 y 910 mm.
- Debajo de la mesa de trabajo se puede introducir el carro ancho de 7 cajones cód. 192876 o el carro de 5 cajones cód. 192861.



192665



129882



129884

Cód.	Material base	P.V.P. unid. €
192665	Sin Encimera	201,17
129882	Madera	436,78
129884	Acero Inox.	500,46



INSTRUCCIONES DE MONTAJE



129882

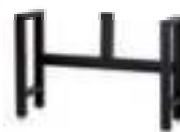

192665



129884



461x909x1361 mm.

Medida caja: 1235x560x173 mm.

100 KG

Carga máxima

Se suministra desmontada.



ARMARIO SUPERIOR

02

- Estructura de acero de 1 mm.
- Puerta con apertura hacia arriba.
- Apertura suave por muelles de gas. Uno a cada lado.



Cód.	P.V.P. unid. €
192848	197,40



281x350x680 mm.



ARMARIO SUPERIOR 2 PUERTAS

- Estructura de acero de 1 mm.



Cerradura centralizada



Cód.	P.V.P. unid. €
192875	174,19



281x350x680 mm.



ARMARIO SUPERIOR ANCHO

- Estructura en acero de 1 mm.
- Puerta con apertura hacia arriba.
- Apertura suave por muelles de gas. Uno a cada lado.



Cód.	P.V.P. unid. €
192877	276,91



281x350x1360 mm.



BANDEJA PARA PANEL PERFORADO

- Estructura y bandeja en acero de 1 mm.
- Base de la bandeja de 602 x 281 mm.



Cód.	P.V.P. unid. €
192850	40,24



281x178x602 mm.



PANEL PERFORADO DE PARED

- Chapa en acero de 1mm.
- Panel con agujeros cuadrados de 10x10 mm (distancia entre centros 38 mm).
- Para ensamblar a cualquier base hacen falta dos pilares de unión 192864.
- Ganchos del pack 113499 compatibles (ver página 64).



24x1052x614 mm.

Cód.	P.V.P. unid. €
192846	117,31



PANEL PERFORADO CON REGLETA DE ENCHUFES

- Mismas características que el panel perforado de pared cód. 192846.
- Incluye regleta eléctrica con interruptor, 3 enchufes y 2 puertos USB.
- Ganchos del pack 113499 compatibles (ver pág. 64)



CABLE COBRE



44x1052x614 mm.

TIPO DE CABLE: H05VV-F



MAX. 3680W - 230 V - 16 A
1,4 M Longitud

Cód.	P.V.P. unid. €
192847	163,31

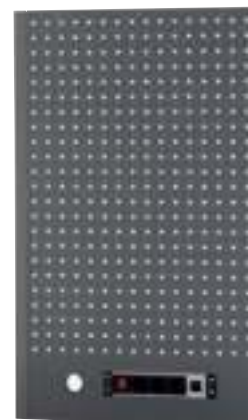



ARMARIO ALTO CON PUERTA DOBLE

- Chapa de acero de 0,8 mm.
- Incluye 4 baldas interiores.



Cerradura centralizada



INSTRUCCIONES DE MONTAJE

Cód.	P.V.P. unid. €
192852	1.005,60
BALDA INTERIOR	
192853	52,33



Balda

Se suministra desmontado.

Baldas interiores.



458x2000x915 mm.



ARMARIO ALTO CON PUERTA SIMPLE

- Chapa de acero de 0,8 mm.
- Incluye 4 baldas interiores.



Cerradura centralizada



INSTRUCCIONES DE MONTAJE

Cód.	P.V.P. unid. €
192851	708,09
BALDA INTERIOR	
192849	44,88



Balda

Se suministra desmontado.

Baldas interiores.



458x2000x600 mm.



CONJUNTO ESQUINERO

- Chapa de acero de 0,8 mm.
- Medidas parte trasera 864x864mm.
- Armarios irregulares de gran capacidad.

COMPOSICIÓN

- 1 armario alto 192834.
- 1 armario base de 1 puerta 192831.
- 2 paneles perforados 192833.
- 1 base de trabajo 192835 (madera) ó 192836 (inox.).
- 4 pilares de unión 192864.



Cerradura centralizada



INSTRUCCIONES DE MONTAJE

Cód.	Material base	P.V.P. unid. €
192841	Madera	1.414,92
192837	Acero Inox.	1.462,04



192841



192837

Se suministra desmontado.



Los componentes del conjunto esquinero no se venden individualmente salvo los pilares de unión cód. 192864.



02



BASE DE TRABAJO DE MADERA

- Tablero aglomerado de 38 mm.
- Lacado especial protector.



192867

Cód.	Para nº módulos	Medida mm	P.V.P. unid. €
192867	1	680 x 463	94,69
192863	2	1420 x 463	235,61
192862	3	2100 x 463	334,89



192863



192862



BASE DE TRABAJO DE ACERO INOXIDABLE

- Chapa de acero inoxidable de 0,5mm de espesor sobre tablero de madera de 38 mm.



192871

Cód.	Para nº módulos	Medida mm	P.V.P. unid. €
192871	1	680 x 463	156,22
192873	2	1420 x 463	299,29
192872	3	2100 x 463	413,91



192873



192872



LÁMPARA LED

- Potencia: 8W.
- Incluye lámpara LED de 600 mm de longitud y cable para conexión entre lamparas LED de 120 mm.



Cód.	P.V.P. unid. €
199246	55,87

No incluye transformador.



TRANSFORMADOR PARA LÁMPARA LED

- Transformador 220V/50-60Hz.
- Salida: 12V/1,5A/18W.
- Válido para conectar a la lámpara LED cód. 199246.



Cód.	P.V.P. unid. €
199247	24,61



PATAS NIVELADORAS

- Base redonda de 42 mm.
- Base de plástico blanco ABS y espesor 12 mm.
- Unión a la base mediante espárrago M10.



Cód.	P.V.P. unid. €
192868	14,81

Pack de 4 unidades.



PILAR DE UNIÓN Y EXTERIOR

- Este pilar es necesario para dar la debida robustez al conjunto modular.
- Cada panel perforado (cód. 192846 ó 192847) precisa de un pilar atornillado a cada lado.
- La unión de los paneles perforados se realiza atornillando dos pilares entre sí.



30x1420x32 mm.

Cód.	P.V.P. unid. €
192864	28,02



GANCHOS PARA PANELES

- Válidos para códigos: 192802, 192804, 192806, 192808, 192676, 192846, 192847, 170798, 192881 y 192886.
- Para cuadrado de panel 10x10 mm.

COMPOSICIÓN 113499 - 16 pzas.

- 10 ganchos simples.
- 2 ganchos dobles.
- 2 ganchos en "U".
- 1 soporte para llaves.
- 1 soporte destornilladores.



113499

	Cód.	Tipo	P.V.P. unid. €
1	113492	Simple	3,90
2	113490	En "U"	4,34
3	113494	Doble	4,69
4	113496	Llaves fijas	15,74
5	113498	Destornilladores	17,20
	113499	Pack 16 piezas	86,84





MESA DE TRABAJO CON 2 CAJONES



Cerradura en 2 cajones

500 KG

Carga máxima



INSTRUCCIONES DE MONTAJE 192675



INSTRUCCIONES DE MONTAJE 192676

PANEL VERTICAL

- Panel en chapa de 1,2 mm.
- Escuadra de refuerzo en el panel.
- Incluye 16 ganchos para colocar herramienta.
- Ganchos disponibles en pág. 64

MESA DE TRABAJO

- Mesa de trabajo en chapa de 2,5 mm.
- Funda de caucho protector para la mesa de trabajo.
- Balda en la parte inferior de la mesa.
- Posibilidad de sujeción al suelo.
- Dos cajones con cerradura propia.
- Pintado rugoso anticorrosión.

INCLUYE:



Funda de caucho protectora



192676



640x1555x1500 mm.

Cajones	Medida mm	Peso admisible Kg
2 cajones	446x420x100	25

Cód.	Descripción	P.V.P. unid. €	
192675	MESA SIN PANEL	749,41	1
192676	MESA CON PANEL	912,29	1

Se suministra desmontada.



192675



640x870x1500 mm.



MESA DE TRABAJO CON 3 CAJONES

- Mesa de trabajo en chapa de 2,5 mm.
- Funda de caucho protector para la mesa.
- Balda en la parte inferior de la mesa.
- Posibilidad de sujeción al suelo.



Cerradura en 3 cajones

500 KG

Carga máxima



INSTRUCCIONES DE MONTAJE

Cajones	Medida mm	Peso admisible Kg
3 cajones	430x450x145	25

Cód.	P.V.P. unid. €	
192677	898,47	1

Se suministra desmontada.



640x870x2000 mm.



MESA DE TRABAJO CON 3 CAJONES Y 2 PORTONES

02

- Chapa de acero 0,6 mm.
- Patas de acero de 2 mm.
- 2 cerraduras comunes para cajones y portones.
- Encimera de tablero aglomerado de 38 mm.
- Estructura modular de montaje rápido.
- Apertura completa de los cajones.
- Cajones con guías a rodamientos de bolas.
- Pies regulables en altura para equilibrado.



Cerradura centralizada

300 KG

Carga máxima



INSTRUCCIONES DE MONTAJE



Cajones	Medida mm	Peso admisible Kg
3 cajones	444x445x175	30

Cód.	P.V.P. unid. €	
129755	1.087,05	1

Se suministra desmontada en 2 cajas:
1ª caja: 1775 x 680 x 340 mm.
2ª caja: 870 x 610 x 370 mm.



92 KG



600x865x1700 mm.



MESA DE TRABAJO CON 3 CAJONES Y 1 PORTÓN

- Chapa de acero 0,6 mm.
- Patas de acero de 2 mm.
- 1 cerradura común para cajones y portones.
- Encimera de tablero aglomerado de 38 mm.
- Estructura modular de montaje rápido.
- Apertura completa de los cajones.
- Cajones con guías a rodamientos de bolas.
- Pies regulables en altura para equilibrado.



Cerradura centralizada

300 KG

Carga máxima



INSTRUCCIONES DE MONTAJE



Cajones	Medida mm	Peso admisible Kg
3 cajones	444x445x175	30

Cód.	P.V.P. unid. €	
129750	805,13	1

Se suministra desmontada en 2 cajas:
1ª caja: 1460 x 680 x 340 mm.
2ª caja: 870 x 610 x 275 mm.



71 KG



600x865x1200 mm.



MESA DE TRABAJO CON 3 CAJONES Y PANEL

- Panel en chapa de 1,2 mm.
- Base en madera MDF.
- Cajón superior.
- Agujeros del panel de 10x10 mm.
- Ganchos disponibles en pág. 64.

220 KG

Carga máxima



Cajones	Medida mm	Peso admisible Kg
2 cajones	457x423x93	10
1 cajón	921x483x99	25

Cód.	P.V.P. unid. €	
170798	501,55	1



609x1739x1142 mm.

Altura de la mesa 920 mm.



02

Se suministra desmontada.



ARMARIO CON PUERTAS CORREDERAS

- Chapa perforada de 1 mm.
- Agujeros de panel 10x10 mm.
- Persiana con cerradura por llave.
- Con orificios atrás para colgar en pared y debajo para colocar sobre la mesa de trabajo.



Cerradura

INCLUYE:



Pack de 16 ganchos 113499

Cód.	Medida mm	P.V.P. unid. €	
192802	1500x750x195	694,37	1
192804	1750x750x195	764,31	1

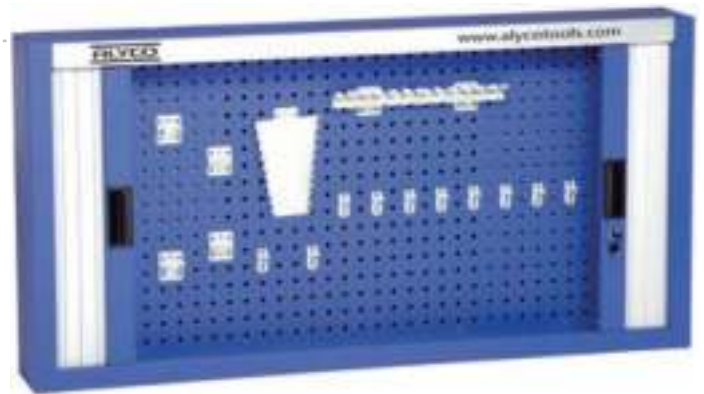

38 KG
44 KG



195x750x1500 mm.
195x750x1750 mm.



PANEL MURAL PARA HERRAMIENTAS

- Chapa perforada de 1 mm.
- Agujeros de panel 10x10 mm.
- Preparado para colgar en la pared.

INCLUYE:



Pack de 16 ganchos 113499

Cód.	Medida mm	P.V.P. unid. €	
192806	1500x750x15	221,71	1
192808	1750x750x15	265,43	1

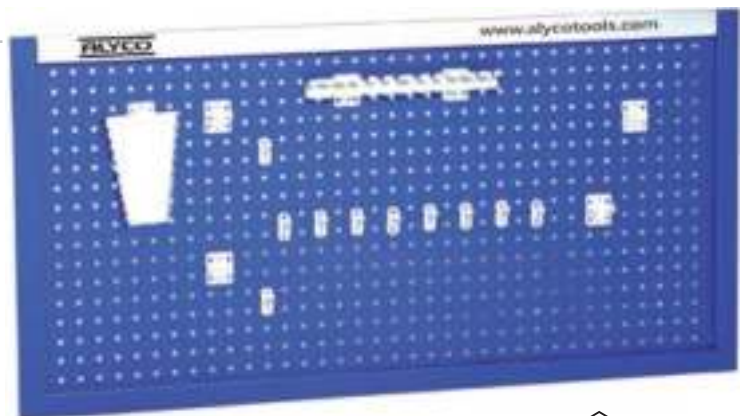

11 KG
13 KG



15x750x1500 mm.
15x750x1750 mm.



BAÚL PARA CONSTRUCCIÓN

02

- Espesor de chapa: 192792 de 1 mm, 192793 de 1,2 mm.
- Presentación pintado rugoso.
- Baúl 192793 incluye bandeja metálica interior.
- Baúl 192792 NO incluye bandeja metálica interior.



Preparado para candado

192792



40 KG



192793



50 KG



Cód.	Medida mm	P.V.P. unid. €	
192792	580x280x287	140,31	1
192793	685x355x332	231,08	1

No incluye herramientas.



CONJUNTO DE 2 BAÚLES PARA CONSTRUCCIÓN

COMPOSICIÓN

192792: Espesor de chapa de 1 mm, presentación pintado rugoso, NO incluye bandeja metálica interior. Medidas: 580x280x287 mm.

192793: Espesor de chapa de 1,2 mm, presentación pintado rugoso, incluye bandeja metálica interior. Medidas: 685x355x332 mm.

192792



+



192793



Cód.	Medida mm	P.V.P. unid. €	
192794	685x355x332	291,85	1

No incluye herramientas.



CAJA DE HERRAMIENTAS METÁLICA, 5 BANDEJAS

- Espesor de chapa 0,6 mm.
- 4 bandejas de 500x95x50 mm.
- 1 bandeja base de 500x200x125 mm.
- Pintado electrostático a dos colores.
- Secado en horno.
- Asas abatibles.



Preparado para candado

28 KG

Carga máxima



200x240x500 mm.

Cód.	P.V.P. unid. €	
192735	73,12	1



CAJA DE HERRAMIENTAS METÁLICA, 3 BANDEJAS

- Espesor de chapa 0,6 mm.
- 2 bandejas de 420x95x50 mm.
- 1 bandeja base de 420x200x125 mm.
- Pintado electrostático a dos colores.
- Secado en horno.
- Asas abatibles.



Preparado para candado

18 KG

Carga máxima



200x200x420 mm.

Cód.	P.V.P. unid. €	
192731	54,09	1



CAJA DE HERRAMIENTAS METÁLICA, 1 BANDEJA

- Espesor de chapa 0,6 mm.
- 1 bandeja base de 420x210x110 mm.
- Pintado electrostático a dos colores.
- Secado en horno.
- Asas abatibles.



Preparado para candado

8 KG

Carga máxima



210x110x420 mm.

Cód.	P.V.P. unid. €	
192733	34,83	1



CAJA DE HERRAMIENTAS METÁLICA, 5 BANDEJAS



- Chapa plegada de 0,6 mm.
- 4 bandejas de 500x95x50 mm.
- 1 bandeja base de 525x200x125 mm.
- Secado al horno.
- Asas abatibles.



Preparado para candado

23 KG

Carga máxima



125x200x525 mm.

Cód.	P.V.P. unid. €	
171130	45,94	1



CAJA DE HERRAMIENTAS METÁLICA, 3 BANDEJAS



- Chapa plegada de 0,6 mm.
- 2 bandejas de 420x95x50 mm.
- 1 bandeja base de 420x200x125 mm.
- Secado al horno.
- Asas abatibles.



Preparado para candado

15 KG

Carga máxima



125x200x420 mm.

Cód.	P.V.P. unid. €	
171135	35,44	1



CAJA DE HERRAMIENTAS METÁLICA REFORZADA

02

- Caja metálica con refuerzos de plástico.
- Chapa plegada de 0,6 mm.
- Asa móvil ergonómica.
- Cierres metálicos.
- Bandeja de plástico extraíble.
- Bisagra con pasador metálico.
- Protectores antichoque.
- Tapa Acero inoxidable (0,5 mm).



Preparado para candado



15 KG
1,5 KG



183352



6,9 KG



183350
Lote 3 cajas.

18 KG
2 KG



183354

22 KG
3,3 KG



183356

Cód.	Medida mm	P.V.P. unid. €	
183352	395x180x170	25,56	1
183354	470x238x203	37,17	1
183356	582x298x255	55,25	1
183350	Lote 3 cajas: 183352+183354+183356	116,94	1



183350



CAJA METÁLICA DE HERRAMIENTAS

- Chapa de 0,4 mm.
- Asa móvil ergonómica.
- Cierres metálicos.
- Bandeja de plástico extraíble.
- Bisagra con pasador metálico.
- Tapa Acero inoxidable (0,3 mm).



Preparado para candado



+

170790
Lote 2 cajas.



Cód.	Medida mm	P.V.P. unid. €	
170780	470x217x210	33,06	1
170785	510x285x250	39,25	1
170790	Lote 2 cajas: 170780+170785	67,54	1



170790





CARRO METÁLICO MODULAR REFORZADO



Preparado para candado

50 KG

Carga máxima

DIMENSIONES

1 caja metálica 580x280x220 mm

1 caja metálica 490x250x220 mm

1 baúl inferior 430x250x430 mm

Cód.

P.V.P. unid. €



183310

282,35

1



Asa extensible telescópica en aluminio.

Asa reforzada de aluminio.



Espesor de chapa 0,8 mm.

Guías de rodamientos a bolas.

Módulos fijados por cierres metálicos.

Ruedas de goma reforzadas de 5".

Baúl con puerta abatible inferior.



320x720x520 mm.

02



CARRO METÁLICO MODULAR

- Carro compuesto por 3 módulos.
- Caja de herramientas superior.
- Cajón central.
- Baúl con puerta abatible inferior.
- Chapa metálica de 0,8 mm.
- Módulos fijados por cierres metálicos.
- Guías de rodamientos a bolas.
- Asa extensible telescópica en aluminio.
- Ruedas de goma de 5".



Preparado para candado

50 KG

Carga máxima

DIMENSIONES

1 caja metálica 580x280x220 mm

1 caja metálica 490x250x220 mm

1 baúl inferior 430x250x430 mm

Cód.

P.V.P. unid. €



183300

208,31

1



320x720x520 mm.



BAÚL DE PLÁSTICO + CAJA DE PLÁSTICO

02

- Carro compuesto por baúl de plástico + caja de plástico con asa de aluminio y cierres metálicos.
- Ambos módulos con bandeja interior de plástico.
- Caja fijada al baúl de plástico mediante cierres metálicos.
- Caja con asa de aluminio y organizador de plástico transparente en la parte superior.
- Asa extensible telescópica.
- Ruedas de goma de gran tamaño.



Preparado para candado

20 KG

Carga máxima



No incluye herramientas



300x500x634 mm.

Cód.	P.V.P. unid. €	
192796	180,88	1

DIMENSIONES	
1 baúl inferior	634x300x279 mm
1 caja plástico	508x256x223 mm



CARRO DE PLÁSTICO MODULAR

- Carro modular en plástico de gran resistencia.
- Compartimento de carga + 3 cajones + caja de plástico con bandeja interior.
- Posibilidad de desmontar en 3 módulos.
- Asa extensible telescópica.
- Ruedas de goma de gran tamaño.



Preparado para candado

20 KG

Carga máxima



No incluye herramientas



300x824x490 mm.

Cód.	P.V.P. unid. €	
192795	110,64	1



BAÚL DE PLÁSTICO 4 EN 1

- Bandeja superior de plástico para herramientas.
- Bandeja inferior de plástico para herramientas.
- Tapa de plástico con alojamientos recubiertos.
- Asa metálica extensible.
- Compartimento de carga de gran volumen.
- Ruedas de goma para su transporte más fácil.



Preparado para candado

20 KG

Carga máxima

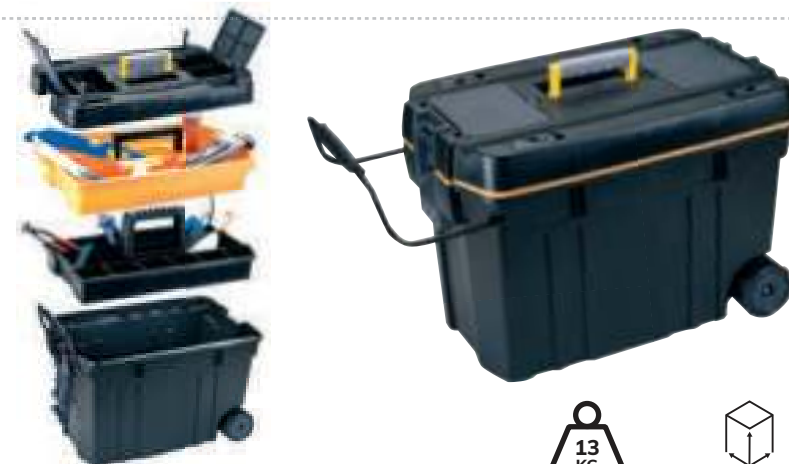

No incluye herramientas



380x420x620 mm.

Cód.	P.V.P. unid. €	
192759	102,90	1



CAJA DE PLÁSTICO CON BANDEJAS EXTRAÍBLES



Preparado para candado



192821

10 KG

Carga máxima



192822

8 KG

Carga máxima



192823

5 KG

Carga máxima



192824

3 KG

Carga máxima

- Cada caja incluye:
 - Bandeja de plástico extraíble con divisiones.
 - Cajas compartimentadas.
 - Dos cajas extraíbles de plástico situadas en la tapa de cada caja.
 - Asa de plástico ergonómica recubierta de caucho.

Cód.	Medida mm	P.V.P. unid. €
192821	606x310x300	38,04
192822	508x250x240	27,37
192823	432x220x180	18,57
192824	355x180x140	10,91



No incluye herramientas



CONJUNTO DE 3 CAJAS DE PLÁSTICO

COMPOSICIÓN

- 192822: 508x250x240 mm
- 192823: 432x220x180 mm
- 192824: 355x180x140 mm



250x240x508 mm.

Cód.	P.V.P. unid. €	
192829	49,29	1



CONJUNTO DE 4 CAJAS DE PLÁSTICO

COMPOSICIÓN

- 192821: 606x310x300 mm
- 192822: 508x250x240 mm
- 192823: 432x220x180 mm
- 192824: 355x180x140 mm



310x300x606 mm.

Cód.	P.V.P. unid. €	
192765	94,26	1



CAJA DE PLÁSTICO REFORZADA

02

- Asa móvil de aluminio ergonómica.
- Cierres metálicos.
- Bandeja de plástico extraíble.
- Bisagra con pasador metálico.
- Protectores antichoque.



Preparado para candado

8 KG

Carga máxima



282x262x490 mm.

Cód.	P.V.P. unid. €	
183370	36,42	1



CAJA DE PLÁSTICO

- Caja de plástico con nervios de refuerzo.
- Cierre metálico en la parte central de la tapa.



Preparado para candado

5 KG

Carga máxima



215x195x420 mm.

Cód.	P.V.P. unid. €	
170795	22,14	1



CAJA DE PLÁSTICO PARA CONSUMIBLES

- 4 cajones con 4 compartimentos cada uno.
- Compartimento superior con tapa de plástico.
- Asa de plástico.



255x240x415 mm.

Cód.	P.V.P. unid. €	
183360	45,30	6

Se pueden apilar hasta 7 cajas



ORGANIZADOR DOBLE PARA CONSUMIBLES

- Caja de doble cara con múltiples divisiones en cada una de ellas.
- Posibilidad de modificar la estructura interna del organizador moviendo los divisores interiores de plástico.
- Con cierres para cada tapa.
- Cubiertas transparentes de policarbonato.

Cód.	Medida mm	P.V.P. unid. €	
192766	320x260x80	13,54	5
192768	380x290x80	17,34	5



No incluye consumibles



ORGANIZADOR PARA CONSUMIBLES CON GRAN CAPACIDAD

- Asa ergonómica y bimaterial.
- Doble cierre lateral de la caja.
- Tapa transparente para poder ver el contenido de los componentes.



Diseño especial de la tapa que organiza las cajas al ser cerradas

Cód.	Compartimentos	P.V.P. unid. €	
192763	8	29,99	5



Compartimentos extraíbles

335x115x420 mm.



ORGANIZADOR ESTRECHO PARA CONSUMIBLES

- Mismas características que el organizador 192763.



Compartimentos extraíbles

335x62x210 mm.

No incluye consumibles

Cód.	Compartimentos	P.V.P. unid. €	
192760	15	11,39	5



ORGANIZADOR ANCHO PARA CONSUMIBLES

- Mismas características que el organizador 192763.



Compartimentos extraíbles

335x62x420 mm.

No incluye consumibles

Cód.	Compartimentos	P.V.P. unid. €	
192762	19	22,09	5



MALETA DE ALUMINIO TROLLEY DE 4 RUEDAS

02

- Estructura metálica con paneles de aluminio.
- 2 paneles para herramientas con elásticos para sujeción.
- Sistema de sujeción de la bandeja en vertical.



Cerradura doble

15 KG

Carga máxima

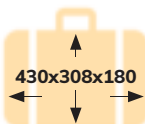

430x308x180

Medidas interiores (mm)

Asa telescópica ajustable



Maleta

Maleta+bolsa 198154



Cerradura doble con candado numérico.

4 ruedas con giro de 360° con posibilidad de extracción.

Cód.	Descripción	Medida mm	P.V.P. unid. €	
198121	MALETA	455x330x200	173,65	1
198122	MALETA + BOLSA	1000x330x200	253,35	1



198122



200x330x455 mm.



MALETA DE ALUMINIO DE 1 BANDEJA

- Bandeja para herramientas con elásticos para sujeción.
- Sistema de sujeción de la bandeja en vertical.
- Base modular con 5 separadores.
- Asa extensible y ruedas para transporte.



Cerradura doble

15 KG

Carga máxima



435x310x105

Medidas interiores (mm)

Asa extensible



Maleta

Maleta+bolsa 198154



330x152x455 mm.

Cód.	Descripción	Medida mm	P.V.P. unid. €	
198110	MALETA	455x330x152	112,00	1
198115	MALETA + BOLSA	770x330x152	191,69	1



198115



MALETA DE ALUMINIO REFORZADA



Cerradura doble

20 KG

Carga máxima

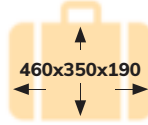

460x350x190
Medidas interiores (mm)



Cód.	Descripción	Medida mm	P.V.P. unid. €	
198100	MALETA	482x340x205	201,00	1
198105	MALETA + BOLSA	800x340x205	280,69	1



340x205x482 mm.



MALETA DE ALUMINIO DE 1 BANDEJA

- Paneles de aluminio.
- Panel interior abatible.
- Refuerzos laterales antichoque.
- Bandejas con elásticos para la sujeción de herramientas.
- Con cinta para colgar del hombro.



Cerradura doble

15 KG

Carga máxima

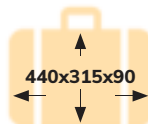

440x315x90
Medidas interiores (mm)



Cód.	P.V.P. unid. €	
170820	90,48	1



330x152x455 mm.



BOLSA DE NYLON CON ASA METÁLICA

02

Polyester 600D

45 KG

Carga máxima



Zona diseñada para artículos de formas diversas y tamaño reducido. Cierre con cremallera.



Zona diseñada para artículos de mayor tamaño (herramienta eléctrica, baterías, pinturas, etc.) Zona portadocumentos cubierta. Cierre con cremallera.



Asa metálica con recubrimiento de goma.

Cinta con refuerzo de goma en la zona de contacto con el hombro.

Zona exterior de la bolsa con diferentes tipos de bolsillos.



245x340x415 mm.

Cód.	P.V.P. unid. €	
198160	96,49	1

No incluye herramientas.



BOLSA DE NYLON CON RUEDAS

Polyester 600D

25 KG

Carga máxima

Cierre de la bolsa mediante cremallera.



Zona interior con bolsillos de diferentes tamaños.

Boca reforzada para mantenerse abierta durante el trabajo.

Asa de nylon reforzada y acolchada.



Soportes de plástico en la base para apoyar en el suelo.

Zonas frontales y laterales con bolsillos de diferentes tamaños.



250x380x440 mm.

Cód.	P.V.P. unid. €	
198150	87,29	1

No incluye herramientas.

Asa de aluminio extensible.



BOLSA DE NYLON CON TROLLEY

- Fabricada en nylon resistente.
- Costura resistente con borde reforzado.
- 6 bolsillos exteriores y 8 interiores.
- Cremallera de nylon con apertura fácil.
- Asa telescópica y ruedas integradas.
- Base rígida de plástico impermeable.
- Lazos laterales ajustables para transporte de herramientas largas.
- Clip metálico exterior para flexómetro.

Polyester
600D

20 KG

Carga
máxima

Cód.

P.V.P. unid. €



198132

93,19

1

No incluye herramientas.



BOLSA DE NYLON PARA PORTÁTIL Y HERRAMIENTAS

Polyester
600D

30 KG

Carga
máxima



Una vez cerrados todos los bolsillos y compartimentos queda totalmente compacta.



Cód.

P.V.P. unid. €



198154

79,70

1

No incluye herramientas.



140x280x360
mm.

02



MOCHILA TROLLEY DE NYLON CON RUEDAS

- Fabricada en nylon resistente.
- Cremallera de nylon con apertura fácil.
- Base rígida de plástico impermeable.
- Mango telescópico abatible de aluminio.



Preparado para candado

20 KG

Carga máxima



Gran bolsillo interior apto para ordenador.
Panel interior extraíble con múltiples compartimentos.



Departamento superior para herramientas pequeñas y documentos.

Asa telescópica con 2 posiciones de extensión.

2 lazos laterales ajustables para transporte de herramientas largas.

2 líneas de lazos frontales.

3 bolsillos externos.

Ruedas integradas.



180x520x320 mm.

Cód.	P.V.P. unid. €	
198135	120,60	1

No incluye herramientas.



MOCHILA TROLLEY DE NYLON CON RUEDAS



- Fabricada en tejido de poliéster.
- Espalda acolchada.
- Bandas de mochila ergonómicas.
- 2 asas exteriores.
- Mango telescópico abatible.
- Compartimentos interiores aptos para herramientas.



Preparado para candado

20 KG

Carga máxima



Función trolley con alojamiento que esconde las bandas de la mochila.
Función mochila con protector de espalda que esconde las ruedas.



230x540x370 mm.

Cód.	P.V.P. unid. €	
171120	88,46	1



MOCHILA DE NYLON CON PANEL INTERIOR

Polyester 600D **30 KG**
Carga máxima

Zona interior con bolsillos de diferentes tamaños.

Cinta reflectora.

Panel rígido con 56 alojamientos.

Asa de nylon reforzada y acolchada.

Zonas frontales y laterales con bolsillos de diferentes tamaños.

Cierre de la bolsa mediante cremallera.

Base reforzada de plástico duro para apoyar en el suelo.

2,2 KG

375x470x180 mm.

Cód.	P.V.P. unid. €	
198152	103,54	1

No incluye herramientas.



MOCHILA DE NYLON

- Fabricada en nylon resistente.
- Cremallera de nylon con apertura fácil.
- Base rígida de plástico impermeable.

Polyester 600D **15 KG**
Carga máxima

Asa de nylon reforzada y acolchada.

Tiras de hombro ajustables y acolchadas.

Compartimento para ordenador.

Compartimento para documentación.

10 bolsillos de diferentes tamaños.

3 bolsillos frontales y 2 laterales.

1,3 KG

180x430x310 mm.

Cód.	P.V.P. unid. €	
198134	60,08	1

No incluye herramientas.



BOLSA DE NYLON ENROLLABLE

- Tejido en Nylon con costuras reforzadas.
- 20 bolsillos de anchura 20-80 mm.
- Cinta elástica central de 17 posiciones.
- 3 bolsillos con cierre de velcro.
- Cierre de bolsa con clips.

Polyester 600D

Medida enrollada 370x100x50 mm.

Medida abierta 740x360 mm.

Cód.	P.V.P. unid. €	
171105	16,61	1

No incluye herramientas.

02



BOLSA DE NYLON

- Fabricada en nylon resistente.
- Costura resistente con borde reforzado.
- 10 bolsillos exteriores y 10 interiores.
- Panel rígido interior extraíble para reforzar el fondo.
- Cremallera de nylon con apertura fácil.
- Base de plástico impermeable.
- Clip metálico exterior para flexómetro.



20 KG

Carga máxima

Cód.	P.V.P. unid. €	
198130	60,67	1

No incluye herramientas.

Asas reforzadas con cierre plástico.

Apertura superior rígida y ancha para fácil acceso.



Correa ajustable acolchada para hombro.



240x300x440 mm.



BOLSA DE NYLON

- Fabricada en nylon resistente.
- Costura resistente con borde reforzado.
- 6 bolsillos exteriores y 6 interiores.
- Cremallera de nylon con apertura fácil.
- Base de plástico impermeable.
- Clip metálico exterior para flexómetro.



15 KG

Carga máxima

Cód.	P.V.P. unid. €	
198125	34,28	1

No incluye herramientas.

Asas reforzadas acolchadas.

Apertura superior rígida y ancha para fácil acceso.



Correa ajustable acolchada para hombro.



190x260x360 mm.



BOLSA DE NYLON

- Asas reforzadas acolchadas.
- Bolsillos interiores.
- Base reforzada impermeable.



20 KG

Carga máxima

Cód.	P.V.P. unid. €	
171100	48,09	1

Apertura superior rígida y ancha para fácil acceso.



250x310x440 mm.





BOLSA DE NYLON

**Polyester
600D**



Posibilidad de sujeción al hombro y la cintura.

Zona exterior con diferentes tipos de bolsillos.



Alojamientos interiores para diversas herramientas.

Cierre principal.

Cinta para hombro acolchada.



80x270x300 mm.

Cód.	P.V.P. unid. €	
196860	41,49	1



BOLSA DE NYLON PARA CINTURÓN

**Polyester
600D**

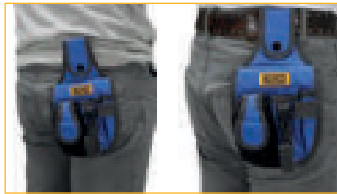

Posibilidad de sujeción al bolsillo y al cinturón.

Refuerzo de nylon acolchado.

Bolsillo de gran tamaño.

Cinturón de nylon ajustable con cierre rápido.

Bolsillo acolchado para material delicado.



20x130x150 mm.

Cód.	P.V.P. unid. €	
196850	10,78	1



BOLSA DE NYLON PARA CONSTRUCCIÓN

- Tejido de nylon con refuerzos interiores.
- Cinturón de nylon ajustable.
- Cierre rápido.

**Polyester
600D**



ESPECIAL CONSTRUCCIÓN



130x310x370 mm.

Cód.	P.V.P. unid. €	
196872	25,81	1

02



BOLSA DE NYLON

Polyester 600D

- Fabricada en nylon con refuerzos interiores.
- Cinturón de nylon ajustable.
- Cierre rápido.



196882



196880

Cód.	P.V.P. unid. €	
196880	23,57	1
196882	20,95	1



170x240x55 mm.



240x240x55 mm.



BOLSA DE NYLON PARA HERRAMIENTA ELECTROPORTÁTIL

Polyester 600D

- Cinturón de nylon ajustable con cierre rápido.
- Correa con cierre rápido para la sujeción de la herramienta electroportátil.



BOLSA DE NYLON INDIVIDUAL

Polyester 600D

- Fabricada en nylon con refuerzos interiores.



Posibilidad de sujeción al cinturón.



Cód.	P.V.P. unid. €	
196852	13,77	1



20x350x170 mm.

Cód.	P.V.P. unid. €	
196848	5,33	1



10x220x90 mm.



BOLSA DE NYLON

Polyester 600D

- Fabricada en nylon con refuerzos interiores.
- Clip metálico en la parte posterior.



Posibilidad de sujeción al bolsillo y al cinturón.



Cód.	P.V.P. unid. €	
171110	11,70	1



65x250x130 mm.

No incluye herramientas.



BOLSA ENROLLABLE

- Fabricada en cuero sintético PU que le confiere una mayor resistencia al sol, mayor comodidad para el mantenimiento, menos transpiración y más ecológico que el cuero convencional.



Cód.	P.V.P. unid. €	
196855	9,20	1



315x Ø120 mm

Medida enrollada.

03

ALICATES Y CORTANTES



Alicate de alta potencia **86**

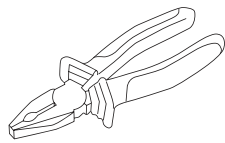

Alicate de corte y manipulación **87**

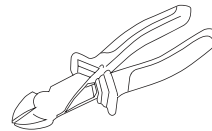

Alicate de corte **88**

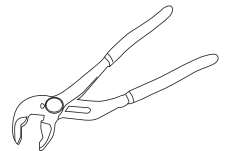

Tenacilla **91**

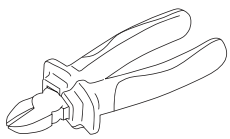

Alicate aislado **94**

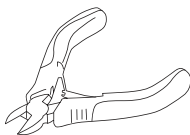

Mini alicate **96**

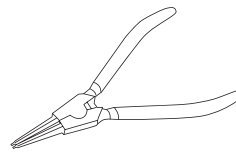

Alicate para arandelas **99**

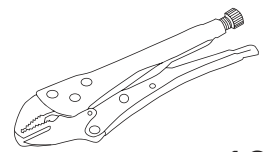

Tenaza grip **101**

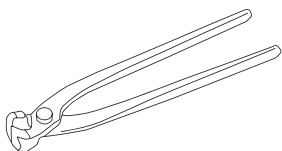

Tenaza rusa **103**

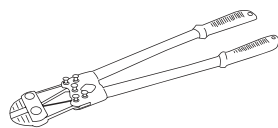

Cortabulón **104**

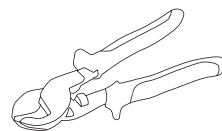

Cortacables **106**

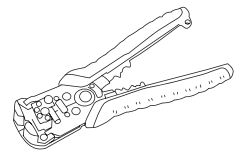

Pelacables **107**

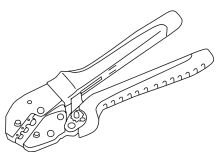

Prensaterminales **109**

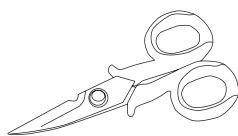

Tijera **111**

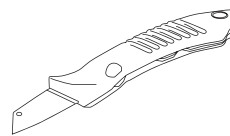

Navaja **114**

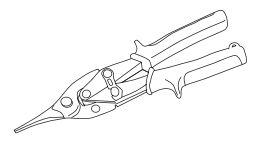

Tijera cortachapas **117**



ALICATE UNIVERSAL DE ALTA POTENCIA

DIN 5746

ACERO CR-V

ALTA POTENCIA

45% MENOR ESFUERZO

Mango bimataterial ergonómico más grueso.

Cód.	L mm	L "	P.V.P. unid. €	
101206	180	7	21,22	6
101208	200	8	26,80	5
101209	225	9	28,02	5

Se suministra con colgador.

CAPACIDAD DE CORTE	
Alambre	Ø mm
	101206
	101208 / 101209
	4,0/5,0/6,0
	2,8/3,5/4,0
	1,8/2,4/2,8
	1,6/2,0/2,4



Filo de corte templado por inducción hasta HRC 62.



Presentación pulido y lacado.

PRINCIPIO DE ALTA POTENCIA

Reducción del esfuerzo hasta un 45% tanto en las operaciones de corte como en las de manipulación (sujetar, doblar, estirar).

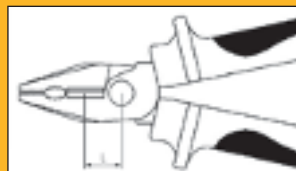

Distancia menor entre el eje de giro y el filo de corte debido a la unión excéntrica del remache.

DISTANCIA EJE - FILO ALICATE UNIVERSAL

L	Alta potencia	Estándar
mm	14	20



ALICATE DE CORTE DIAGONAL

DIN 5749

ACERO CR-V

ALTA POTENCIA

Cód.	L mm	L "	P.V.P. unid. €	
110304	160	6	21,32	6
110305	180	7	25,58	5

Se suministra con colgador.

CAPACIDAD DE CORTE	
Alambre	Ø mm
	110304
	110305
	4,0
	3,0
	2,0
	1,6



ALICATE DE CORTE DIAGONAL REFORZADO

DIN 5749

ACERO CR-V

ALTA POTENCIA

Cód.	L mm	L "	P.V.P. unid. €	
101312	200	8	26,80	5

Se suministra con colgador.

CAPACIDAD DE CORTE	
Alambre	Ø mm
	101312
	5,0
	3,5
	2,4
	2,0



ALICATE DE PUNTAS SEMIREDONDAS RECTO CON CORTE

DIN 5745

ACERO CR-V

ALTA POTENCIA

Cód.	L mm	L "	P.V.P. unid. €	
101303	160	6	22,12	6
101304	200	8	27,36	5

Se suministra con colgador.



ALAMBRE DE CORTE: Blando / Semiduro / Duro / Cuerda piano



ALICATE UNIVERSAL

DIN 5746 ACERO CR-V

- Filos de corte templados por inducción.
- Terminación pulido y lacado (antióxido).
- Mangos bimateriales y ergonómicos.

Cód.	L mm	L "	P.V.P. unid. €	
101200	130	5	13,24	6
101201	160	6	14,42	6
101202	180	7	15,68	6
101203	200	8	17,03	6

Se suministra con colgador.



CAPACIDAD DE CORTE	
Alambre	Ø mm
	101200 / 101201 101202 / 101203
○	4,0/4,0/4,0
◐	2,8/3,0/3,0
◑	1,8/2,0/2,0
●	1,4/1,6/1,6



ALICATE DE PUNTAS SEMIREDONDAS CON CORTE

DIN 5745 ACERO CR-V



Cód.	L mm	L "	P.V.P. unid. €	
101300	140	5,5	14,05	6
101301	160	6,0	15,16	6
101302	200	8,0	17,18	6

Se suministra con colgador.



ALICATE DE PUNTAS SEMIREDONDAS BOCA CURVA

DIN 5745 ACERO CR-V



Cód.	L mm	L "	P.V.P. unid. €	
101310	200	8	18,85	6

Se suministra con colgador.



ALICATE DE BOCAS PLANAS

DIN 5745 ACERO CR-V



Cód.	L mm	L "	P.V.P. unid. €	
102201	160	6	14,20	6

Se suministra con colgador.



ALICATE DE PUNTIAS REDONDAS

DIN 5745 ACERO CR-V



Cód.	L mm	L "	P.V.P. unid. €	
104101	160	6	15,23	6

Se suministra con colgador.



ALICATE PELACABLES

ACERO CR-V

- Con tornillo para regular al diámetro del cable.

Cód.	L mm	L "	P.V.P. unid. €	
107101	160	6	20,09	6

Se suministra con colgador.



ALAMBRE DE CORTE: ○ Blando / ◐ Semiduro / ◑ Duro / ● Cuerda piano

03



ALICATE DE CORTE DIAGONAL

DIN 5749

ACERO CR-V

- Filos de corte templados por inducción.
- Terminación pulido y lacado (antióxido).
- Mangos bimateriales y ergonómicos.



CAPACIDAD DE CORTE	
Alambre	Ø mm
○	110302
○	110303

Cód.	L mm	L "	P.V.P. unid. €	📦
110301	130	5,5	14,37	6
110302	160	6,0	15,03	6
110303	180	7,0	16,31	6

Se suministra con colgador.



ALICATE DE CORTE DIAGONAL AL RAS

DIN 5749

ACERO CR-V

- Filos de corte templados por inducción.
- Terminación pulido y lacado (antióxido).
- Especialmente indicado para PVC.
- Mangos bimateriales y ergonómicos.



CAPACIDAD DE CORTE	
Alambre	Ø mm
○	110307
○	110307

Cód.	L mm	L "	P.V.P. unid. €	📦
110307	160	6,0	16,47	5



ALICATE DE CORTE DIAGONAL REFORZADO

DIN 5749

ACERO CR-V



CAPACIDAD DE CORTE	
Alambre	Ø mm
○	110310
○	110311

Cód.	L mm	L "	P.V.P. unid. €	📦
110309	160	6	16,30	6
110310	180	7	18,25	6
110311	200	8	19,51	6

Se suministra con colgador.



ALICATE DE CORTE FRONTAL

DIN 5748

ACERO CR-V



CAPACIDAD DE CORTE	
Alambre	Ø mm
○	111100
○	111101

Cód.	L mm	L "	P.V.P. unid. €	📦
111100	160	6	17,36	6
111101	200	8	20,47	6

Se suministra con colgador.



JUEGO DE ALICATES EN CAJA DE PLÁSTICO



ALTA POTENCIA



Medida de caja: 255x185x48mm

COMPOSICIÓN

101206 / 110305 / 101304

Cód.	Nº Piezas	P.V.P. unid. €	📦
101217	3	74,16	1



JUEGO DE ALICATES EN CAJA DE PLÁSTICO



Medida de caja: 255x185x48mm

COMPOSICIÓN

101202 / 110303 / 101302

Cód.	Nº Piezas	P.V.P. unid. €	📦
101210	3	55,48	1

ALAMBRE DE CORTE: ○ Blando / ◐ Semiduro / ● Duro / ● Cuerda piano



ALICATE UNIVERSAL

DIN 5746

ACERO CR-V

ACABADO TEFLONADO

- Cuerpo templado (HRC 45÷47).
- Filos de corte templados por inducción (HRC 50÷53).
- Terminación con recubrimiento de teflón (antióxido).
- Mangos bimateriales ergonómicos.



Cód.	L mm	L "	P.V.P. unid. €	
170516	160	6	6,04	6
170518	180	7	6,69	6
170520	200	8	7,95	6

Se suministra con colgador.



ALICATE DE CORTE DIAGONAL

DIN 5749

ACERO CR-V

ACABADO TEFLONADO



Cód.	L mm	L "	P.V.P. unid. €	
170550	130	5	5,79	6
170555	160	6	6,19	6
170560	180	7	7,72	6

Se suministra con colgador.



ALICATE DE CORTE DIAGONAL REFORZADO

DIN 5749

ACERO CR-V

ACABADO TEFLONADO



Cód.	L mm	L "	P.V.P. unid. €	
170570	190	7,5	7,66	6

Se suministra con colgador.



ALICATE DE CORTE FRONTAL

DIN 5748

ACERO CR-V

ACABADO TEFLONADO



Cód.	L mm	L "	P.V.P. unid. €	
170575	160	6	7,20	6

Se suministra con colgador.



ALICATE DE PUNTAS SEMIREDONDAS CON CORTE

DIN 5745

ACERO CR-V

ACABADO TEFLONADO



170536



Cód.	Bocas	L mm	L "	P.V.P. unid. €	
170530	Rectas	160	6	6,27	6
170535	Rectas	200	8	6,90	6
170536	Curvas	200	8	7,43	6

Se suministra con colgador.

03



ALICATE DE BOCAS PLANAS



DIN 5745

ACERO CR-V

ACABADO TEFLONADO



Cód.	L mm	L "	P.V.P. unid. €	
170580	160	6	6,07	6



ALICATE DE PUNTAS REDONDAS



DIN 5745

ACERO CR-V

ACABADO TEFLONADO



Cód.	L mm	L "	P.V.P. unid. €	
170590	160	6	5,79	6



ALICATE PELACABLES



ACERO CR-V

ACABADO TEFLONADO



Cód.	L mm	L "	P.V.P. unid. €	
170595	160	6	7,62	6



JUEGO DE ALICATES EN BLÍSTER



COMPOSICIÓN

170518 / 170555 / 170542

Cód.	Nº piezas	P.V.P. unid. €	
170509	3	22,54	3



JUEGO DE ALICATES EN BLÍSTER



COMPOSICIÓN

170518 / 170530 / 170555

Cód.	Nº piezas	P.V.P. unid. €	
170528	3	19,10	3



TENACILLA DE AJUSTE AUTOMÁTICO

ACERO
CR-V-MO

- Dentado de las mordazas templado (60 HRC).
- Grosor de las bocas 12 mm. Permite una gran fuerza de apriete (muy superior a las tenacillas estándar).
- Terminación: pavonado, bocas pulidas.
- Mangos recubiertos en PVC.

AJUSTE CON UNA SOLA MANO
SIN PULSAR NINGÚN BOTÓN

03



Cód.	L mm	L "	Capac. máx. mm	P.V.P. unid. €	
115140	240	9,5	42	32,56	6

Se suministra con colgador.



TENACILLA DE AJUSTE RÁPIDO

ACERO
CR-V

- Dentado templado por alta frecuencia (HRC 55-60).
- Terminación: pavonado y bocas pulidas.
- Mangos recubiertos de material rugoso.



Gran capacidad.
23 posiciones de ajuste

Gran profundidad de
las bocas

Valores para 115125



Cód.	L mm	L "	Capac. máx. mm	Profundidad bocas mm	P.V.P. unid. €	
115115	150	6,0	28	26	26,19	6
115120	180	7,0	37	32	29,24	6
115125	240	9,5	49	38	31,67	6
115130	300	12,0	68	47	45,07	5
115135	400	16,0	95	64	81,62	3

Se suministra con colgador (excepto 115135).



TENAZA PICO DE LORO

DIN
8976

ACERO
CR-V

- Cremallera mecanizada.
- Terminación cromado.



Cód.	L mm	L "	Capac. máx. mm	P.V.P. unid. €	
111199	200	8	35	20,63	6
111200	250	10	50	24,19	6
111201	300	12	50	35,21	6

Se suministra con colgador.



TENACILLA DE CANAL

DIN 8976

ACERO CR-V

- Apertura en 7 posiciones.
- Terminación pavonado.
- Articulación machihembrada.
- Bocas templadas.



Cód.	L mm	L "	Capac. máx. \varnothing mm	P.V.P. unid. €	
115105	250	10	36	31,55	6

Se suministra con colgador.



TENACILLA DE CANAL

DIN 8976

ACERO CR-V

- Apertura en 7 posiciones.
- Terminación pintura epoxi.
- Articulación machihembrada.
- Bocas templadas.



Cód.	L mm	L "	Capac. máx. \varnothing mm	P.V.P. unid. €	
115100	250	10	34	28,57	6



TENAZA PICO DE LORO

DIN 8976

ACERO CR-V

ACABADO TEFLONADO

- Cremallera mecanizada.
- Capacidad máxima \varnothing tubo 6-36 mm.



Cód.	L mm	L "	P.V.P. unid. €	
170540	240	10	9,65	12



TENACILLA DE CANAL

DIN 8976

ACERO CR-V

ACABADO TEFLONADO

- Articulación machihembrada.
- Capacidad máxima \varnothing tubo 6-36 mm.



Cód.	L mm	L "	P.V.P. unid. €	
170542	250	10	9,75	12



ALICATE UNIVERSAL DE ALTA POTENCIA AISLADO

CERTIFICADO VDE

DIN 5746
EN 60900

ACERO CR-V



1000 V

Marcado indeleble en cumplimiento de la norma EN 60900.

NORMA EN 60900:
Trabajos en tensión de hasta 1000 V en Corriente Alterna ó 1500 V en Corriente Continua.

Mangos recubiertos de material especial aislante.



ALTA POTENCIA



CAPACIDAD DE CORTE

Alambre	Ø mm
○	101804 101805 4,0/5,0
◐	2,8/3,5
◑	1,8/2,4
●	1,6/2,0

Cód.	L mm	L "	P.V.P. unid. €	📦
101804	180	7	29,04	6
101805	200	8	32,51	5

Se suministra con colgador.



ALICATE DE CORTE DIAGONAL AISLADO

CERTIFICADO VDE

DIN 5749
EN 60900

ACERO CR-V



1000 V

ALTA POTENCIA



CAPACIDAD DE CORTE

Alambre	Ø mm
○	101823 101824 4,0
◐	3,0
◑	2,0
●	1,6

Cód.	L mm	L "	P.V.P. unid. €	📦
101823	160	6	27,12	6
101824	180	7	29,18	5

Se suministra con colgador.



ALICATE DE PUNTAS SEMIREDONDAS AISLADO

CERTIFICADO VDE

DIN 5745
EN 60900

ACERO CR-V



1000 V

ALTA POTENCIA



Cód.	L mm	L "	P.V.P. unid. €	📦
101812	160	6	29,50	6
101813	200	8	32,48	5

Se suministra con colgador.



JUEGO DE ALICATES AISLADOS

CERTIFICADO VDE



1000 V

ALTA POTENCIA

COMPOSICIÓN
101804 / 101824 / 101813

Cód.	Nº Piezas	P.V.P. unid. €	📦
101862	3	92,91	1



Medida caja: 255x185x48mm



ALICATE UNIVERSAL AISLADO

CERTIFICADO **VDE**

DIN 5746 EN 60900 ACERO CR-V D'E GS 1000 V



CAPACIDAD DE CORTE

Alambre	∅ mm
	101801 / 101802 / 101803
○	4,0/4,0/4,0
◐	2,8/3,0/3,0
◑	1,8/2,0/2,0
●	1,4/1,6/1,6

03

NORMA EN 60900:

Trabajos en tensión de hasta 1000 V en Corriente Alterna ó 1500 V en Corriente Continua.

Cód.	L mm	L "	P.V.P. unid. €	
101801	160	6	24,63	6
101802	180	7	26,13	6
101803	200	8	28,34	5

Se suministra con colgador.



ALICATE DE CORTE DIAGONAL AISLADO

CERTIFICADO **VDE**

DIN 5749 EN 60900 ACERO CR-V D'E GS 1000 V



Cód.	L mm	L "	P.V.P. unid. €	
101821	160	6	24,63	6
101822	180	7	27,74	5

Se suministra con colgador.



ALICATE DE CORTE DIAGONAL REFORZADO AISLADO

CERTIFICADO **VDE**

DIN 5749 EN 60900 ACERO CR-V D'E GS 1000 V



Cód.	L mm	L "	P.V.P. unid. €	
101825	180	7	28,26	6
101826	200	8	31,09	6

Se suministra con colgador.



ALICATE PUNTAS SEMIREDONDAS AISLADO

CERTIFICADO **VDE**

DIN 5745 EN 60900 ACERO CR-V D'E GS 1000 V



Cód.	L mm	L "	P.V.P. unid. €	
101810	160	6	25,45	6
101811	200	8	29,57	6

Se suministra con colgador.



ALICATE PUNTAS SEMIREDONDAS CURVO AISLADO

CERTIFICADO **VDE**

DIN 5745 EN 60900 ACERO CR-V D'E GS 1000 V



Cód.	L mm	L "	P.V.P. unid. €	
101815	200	8	30,20	6

Se suministra con colgador.

ALAMBRE DE CORTE: ○ Blando / ◐ Semiduro / ◑ Duro / ● Cuerda piano



ALICATE DE BOCAS PLANAS AISLADO

DIN 5745
EN 60900

ACERO CR-V



CERTIFICADO VDE



Cód.	L mm	L "	P.V.P. unid. €	
101835	160	6	24,75	6

Se suministra con colgador.



ALICATE PUNTAS REDONDAS AISLADO

DIN 5745
EN 60900

ACERO CR-V



CERTIFICADO VDE



Cód.	L mm	L "	P.V.P. unid. €	
101830	160	6	24,17	6

Se suministra con colgador.



ALICATE PELACABLES AISLADO

EN 60900

ACERO CR-V



CERTIFICADO VDE



Cód.	L mm	L "	P.V.P. unid. €	
101840	160	6	34,30	6

Se suministra con colgador.



TENACILLA DE CANAL AISLADA

DIN 8976
EN 60900

ACERO CR-V



CERTIFICADO VDE



Cód.	L mm	L "	P.V.P. unid. €	
101845	240	9,5	35,76	6

Se suministra con colgador.



ALICATE CORTACABLES AISLADO

EN 60900

ACERO CR-V



CERTIFICADO VDE

- Filos de corte para cables.
- Terminación cabeza pulida.
- Con tope mecánico.
- Mangos bimateriales y ergonómicos.



No válido para cortar alambre de Acero o conductores de Cobre trenzado



Cód.	L mm	L "	P.V.P. unid. €	
101848	250	10	54,07	6

Se suministra con colgador.

CAPACIDAD DE CORTE

Cable Ø mm

13,5



JUEGO DE ALICATES AISLADOS

CERTIFICADO VDE



Medida caja: 255x185x48mm



COMPOSICIÓN

101802 / 101822 / 101811

Code	Nº Piezas	P.V.P. unid. €	
101860	3	83,58	1

ALAMBRE DE CORTE: ○ Blando / ◐ Semiduro / ● Duro / ● Cuerda piano



MINIALICATE DE PRECISI3N DE CORTE DIAGONAL



Tipo de corte biselado para una mayor capacidad de corte y vida del filo cortante.

- Filos de corte endurecidos a 55-60 HRC.
- Temple total del alicate.
- Terminaci3n pulido y lacado (anti3xido).
- Mangos bimateriales antideslizantes.
- Muelle para una utilizaci3n m3s ergon3mica.



Mangos disipativos de electricidad est3tica:
Mangos recubiertos de material especial que disipan la electricidad est3tica generada al trabajar en aparatos el3ctricos como electrodom3sticos, ordenadores, circuitos electr3nicos...



C3d.	L mm	L "	P.V.P. unid. €	
113175	115	4,5	16,51	12

Se suministra con colgador.

03



MINIALICATE DE PRECISI3N UNIVERSAL



C3d.	L mm	L "	P.V.P. unid. €	
113185	115	4,5	16,51	12

Se suministra con colgador.



MINIALICATE DE PRECISI3N DE CORTE FRONTAL



C3d.	L mm	L "	P.V.P. unid. €	
113180	115	4,5	16,51	12

Se suministra con colgador.



MINIALICATE DE PRECISI3N DE BOCAS PLANAS



C3d.	L mm	L "	P.V.P. unid. €	
113165	130	5	16,51	12

Se suministra con colgador.



MINIALICATE DE PRECISI3N DE BOCAS REDONDAS



C3d.	L mm	L "	P.V.P. unid. €	
113170	130	5	16,51	12

Se suministra con colgador.



MINIALICATE DE PRECISI3N DE PUNTAS SEMIREDONDAS CON CORTE



C3d.	L mm	L "	P.V.P. unid. €	
113155	140	5,5	16,51	12

Se suministra con colgador.



MINIALICATE DE PRECISIÓN DE PUNTAS SEMIREDONDAS

ACERO CR-V



- Boca interior lisa.

Cód.	L mm	L "	P.V.P. unid. €	
113160	150	6	16,51	12

Se suministra con colgador.



MINIALICATE PARA ELECTRÓNICA DE CORTE DIAGONAL

ACERO CR-V



MINIALICATE PARA ELECTRÓNICA DE CORTE DIAGONAL

ACERO CR-V



- Ángulo de corte muy preciso debido a la técnica de fabricación.

21°
Ángulo corte



- Ángulo de corte muy preciso debido a la técnica de fabricación.

45°
Ángulo corte



Cód.	L mm	L "	P.V.P. unid. €	
113192	125	5	15,96	12

Se suministra con colgador.

Cód.	L mm	L "	P.V.P. unid. €	
113194	125	5	15,96	12

Se suministra con colgador.



JUEGO DE MINIALICATES

COMPOSICIÓN

113160 / 113175 / 113185 / 113180

Cód.	Nº Piezas	P.V.P. unid. €	
113190	4	63,83	1



Medida de caja: 255x185x48mm



PINZA DE PRECISIÓN BOCA RECTA

ACERO INOX

- Acabado antideslizante.
- Antimagnético, antiácido.



Cód.	L mm	L "	P.V.P. unid. €	
113142	120	5	6,40	6



PINZA DE PRECISIÓN BOCA CURVA

ACERO INOX

- Acabado antideslizante.
- Antimagnético, antiácido.



Cód.	L mm	L "	P.V.P. unid. €	
113144	120	5	5,13	6

03



MINIALICATE UNIVERSAL



ACABADO
TEFLONADO

- Cuerpo templado (HRC 40÷44).
- Filos de corte templados por inducción (HRC 58÷62).
- Terminación: Teflonado (antióxido).
- Mangos bimateriales.
- Muelle de apertura.



Cód.	L mm	L "	P.V.P. unid. €	
170502	120	5	4,59	12

Se suministra con colgador.



MINIALICATE DE CORTE DIAGONAL



ACABADO
TEFLONADO



Cód.	L mm	L "	P.V.P. unid. €	
170504	115	5	4,59	12

Se suministra con colgador.



MINIALICATE DE CORTE FRONTAL



ACABADO
TEFLONADO



Cód.	L mm	L "	P.V.P. unid. €	
170505	105	4	4,59	12

Se suministra con colgador.



MINIALICATE DE PUNTAS SEMIREDONDAS DE CORTE



ACABADO
TEFLONADO



Cód.	L mm	L "	P.V.P. unid. €	
170503	130	5	4,59	12

Se suministra con colgador.



MINIALICATE PUNTAS SEMIREDONDAS



ACABADO
TEFLONADO



Cód.	L mm	L "	P.V.P. unid. €	
170506	150	6	4,59	12

Se suministra con colgador.



MINIALICATE BOCAS PLANAS



ACABADO
TEFLONADO



Cód.	L mm	L "	P.V.P. unid. €	
170507	125	5	4,59	12

Se suministra con colgador.



MINIALICATE BOCAS REDONDAS



ACABADO
TEFLONADO



Cód.	L mm	L "	P.V.P. unid. €	
170508	130	5	4,59	12

Se suministra con colgador.



JUEGO ALICATES DE PRECISIÓN



COMPOSICIÓN

170502 / 170504 / 170505 / 170503 / 170506

Cód.	Nº piezas	P.V.P. unid. €	
170529	5	20,49	6



ALICATE PARA ARANDELAS SEEGER

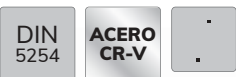

EXTERIORES BOCA RECTA



Cód.	Ø mm	L mm	P.V.P. unid. €	
106202	10 a 25	140	19,15	6
106203	19 a 60	180	19,98	6
106204	40 a 100	220	23,20	6
106220	85 a 165	300	35,56	6

Se suministra con colgador.



ALICATE PARA ARANDELAS SEEGER

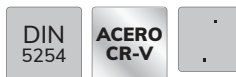

EXTERIORES BOCA CURVA



Cód.	Ø mm	L mm	P.V.P. unid. €	
106206	10 a 25	140	18,23	6
106207	19 a 60	180	20,58	6
106208	40 a 100	220	24,02	6
106225	85 a 165	300	35,94	6

Se suministra con colgador.



ALICATE PARA ARANDELAS SEEGER



INTERIORES BOCA RECTA



Cód.	Ø mm	L mm	P.V.P. unid. €	
106209	12 a 25	140	19,15	6
106210	19 a 60	180	21,41	6
106211	40 a 100	220	22,87	6
106230	85 a 165	300	35,33	6

Se suministra con colgador.



ALICATE PARA ARANDELAS SEEGER



INTERIORES BOCA CURVA



Cód.	Ø mm	L mm	P.V.P. unid. €	
106212	12 a 25	140	17,95	6
106213	19 a 60	180	20,74	6
106214	40 a 100	220	23,71	6
106235	85 a 165	300	36,74	6

Se suministra con colgador.



JUEGO ALICATES PARA ARANDELAS SEEGER, CAJA DE PLÁSTICO



Medida caja: 255x185x48mm

COMPOSICIÓN

101218: 106202 / 106206 / 106209 / 106212 (L: 140mm)
 101220: 106203 / 106207 / 106210 / 106213 (L: 180mm)

Cód.	Nº Piezas	P.V.P. unid. €	
101218	4	73,84	1
101220	4	81,91	1



JUEGO ALICATES PARA ARANDELAS SEEGER, BOLSA DE NYLON



COMPOSICIÓN

106204 / 106208 / 106211 / 106214 (L: 220mm)

Cód.	Nº Piezas	P.V.P. unid. €	
101222	4	95,75	1

03



ALICATE PARA ARANDELAS SEEGER



DIN 5254 ACERO CR-V

EXTERIORES BOCA RECTA

■ Acabado: Teflonado (antióxido).



Cód.	Ø mm	L mm	P.V.P. unid. €	
170576	10 a 25	150	5,59	6
170585	19 a 60	180	6,37	6

Se suministra con colgador.



ALICATE PARA ARANDELAS SEEGER



DIN 5254 ACERO CR-V

EXTERIORES BOCA CURVA

■ Acabado: Teflonado (antióxido).



Cód.	Ø mm	L mm	P.V.P. unid. €	
170577	10 a 25	150	5,59	6
170586	19 a 60	180	6,37	6



ALICATE PARA ARANDELAS SEEGER



DIN 5256 ACERO CR-V

INTERIORES BOCA RECTA

■ Acabado: Teflonado (antióxido).



Cód.	Ø mm	L mm	P.V.P. unid. €	
170578	12 a 25	150	5,59	6
170587	19 a 60	180	6,37	6



ALICATE PARA ARANDELAS SEEGER



DIN 5256 ACERO CR-V

INTERIORES BOCA CURVA

■ Acabado: Teflonado (antióxido).



Cód.	Ø mm	L mm	P.V.P. unid. €	
170579	12 a 25	150	5,59	6
170588	19 a 60	180	6,37	6



JUEGO ALICATES PARA ARANDELAS SEEGER EN BLÍSTER



DIN 5254 DIN 5256 ACERO CR-V

INTERIORES Y EXTERIORES, BOCA RECTA Y BOCA CURVA



COMPOSICIÓN

170582: 170576 / 170577 / 170578 / 170579 (L: 150mm)

170584: 170585 / 170586 / 170587 / 170588 (L: 180mm)

Cód.	Nº Piezas	P.V.P. unid. €	
170582	4	20,30	6
170584	4	21,98	6





TENAZA GRIP DE BOCAS CURVAS CON CORTE

ACERO CR-V



AM: apertura máxima



03

Cód.	L mm	L "	AM mm	P.V.P. unid. €	
109101	135	5,5	30	11,38	3
109102	190	7,5	42	16,22	3
109103	235	9,0	63	18,60	3

Se suministra en blíster.



TENAZA GRIP DE BOCAS RECTAS

ACERO CR-V



AM: apertura máxima



Cód.	L mm	L "	AM mm	P.V.P. unid. €	
109104	190	7,5	42	16,49	3
109105	235	9,0	63	19,50	3

Se suministra en blíster.



TENAZA GRIP DE BOCAS CURVAS CON CORTE

ACERO CR-V

- Bocas forjadas endurecidas por inducción.
- Mangos ergonómicos.



AM: apertura máxima



Cód.	L mm	L "	AM mm	P.V.P. unid. €	
170562	175	7	42	12,02	6
170564	225	9	63	14,33	6

Se suministra con colgador.



TENAZA GRIP TIPO C

ACERO CR-V

Gran capacidad de carga. Especialmente adecuada para la soldadura de ángulos metálicos, barras en "U" y perfiles.

Tuerca moleteada de fijación para la regulación a la apertura deseada.

Acabado cromado para una mejor resistencia a la corrosión.

Palanca de desbloqueo rápido.



Cód.	L mm	L "	P.V.P. unid. €	
109007	300	12	24,13	1

Se suministra en blíster.



TENAZA GRIP DE CADENA

ACERO CR-V

- Cadena fabricada en acero al carbono.
- Acabado cromado para una mejor resistencia a la corrosión.
- Especialmente indicada para objetos de forma irregular y circular.
- Dispone de palanca de desbloqueo rápido.

CAPACIDAD MÁXIMA Ø 160 MM



Cód.	L mm	L "	P.V.P. unid. €	
109009	250	10	34,22	1

Se suministra en blíster.



TENAZA GRIP PARA SOLDADOR

ACERO CR-V

- Acabado cromado para una mejor resistencia a la corrosión.
- El espacio existente entre las patas es idóneo para trabajos con soplete, antorcha o electrodo en los diferentes proceso de soldadura.
- Dispone de palanca de desbloqueo rápido.



Cód.	L mm	L "	P.V.P. unid. €	
109015	250	10	20,93	1

Se suministra en blíster.



TENAZA DE ALTA POTENCIA

ACERO CR-V

- Filos de corte endurecidos a HRC 58÷62.
- Cuerpo templado a HRC 45.
- Terminación pavonado.

CAPACIDAD DE CORTE

Acero	Ø mm
○	6,0
◐	4,5
●	2,5



03

PRINCIPIO DE ALTA POTENCIA
Reducción del esfuerzo hasta un 50%



Distancia menor entre el eje de giro y el filo de corte.

DISTANCIA EJE-FILO TENAZA

L mm	Alta potencia	Estándar
	20,5	30

Cód.	L mm	L "	P.V.P. unid. €	📦
114010	300	12	29,24	6

Se suministra con colgador.



TENAZA RUSA

DIN 9242

ACERO CR-V

- Filos de corte endurecidos por inducción.
- Cabeza Pulida.
- Terminación pavonado.



CAPACIDAD DE CORTE

Acero	Ø mm
○	4
◐	3
●	2

Cód.	L mm	L "	P.V.P. unid. €	📦
114005	225	9	13,11	6
114006	250	10	14,95	6
114007	280	11	15,98	6

Se suministra con colgador.



TENAZA RUSA, MANGOS PLASTIFICADOS

DIN 9242

ACERO CR-V

- Filos de corte endurecidos por inducción.
- Cabeza Pulida.
- Terminación pavonado.
- Mangos revestidos en PVC.



Cód.	L mm	L "	P.V.P. unid. €	📦
114015	225	9	13,36	6
114016	250	10	15,46	6
114017	280	11	16,03	6

Se suministra con colgador.



TENAZA RUSA, MANGOS PLASTIFICADOS



DIN 9242

ACERO CR-V

- Filos de corte templados a 55÷58 HRC.
- Mangos revestidos en PVC.



Cód.	L mm	L "	P.V.P. unid. €	📦
170602	250	10	11,00	6
170604	300	12	12,99	6

Se suministra con colgador.



TENAZA DE ARRANCAR

DIN 9243

ACERO CR-V

- Filos de corte endurecidos por inducción.
- Cabeza Pulida.
- Terminación pavonado.



Cód.	L mm	L "	P.V.P. unid. €	📦
114002	180	7	18,42	6
114003	200	8	19,81	6

Se suministra con colgador.

ALAMBRE DE CORTE: ○ Blando / ◐ Semiduro / ● Duro / ● Cuerda piano



CORTABULÓN-DOBLADOR DE BARRAS

ACERO
CR-V-MO

CAPACIDAD DE CORTE-DOBLADO

Cód.	Corte Ø mm		Doblado Ø mm
	15 HRC	40 HRC	
123010	7	4	—
123031	8	5	6
123032	10	6	8
123033	13	7	9
123034	16	8	12



Cód.	L mm	L "	P.V.P. unid. €	
123010	350	14	46,71	1
123031	450	18	63,96	1
123032	600	24	75,03	1
123033	750	30	100,10	1
123034	900	36	126,57	1



Se suministra en caja de cartón individual.

EXPOSITOR		
Cód.	Nº Piezas	P.V.P. unid. €
123120	7	625,98



COMPOSICIÓN

123031(2) / 123032(2)
123033(2) / 123034(1)



CUCHILLAS



CUCHILLA DE RECAMBIO

123110	para Cód. 123010	30,10	1
123111	para Cód. 123031	37,27	1
123112	para Cód. 123032	47,82	1
123113	para Cód. 123033	60,97	1
123114	para Cód. 123034	70,25	1



MODO EMPLEO DOBLADOR BARRAS

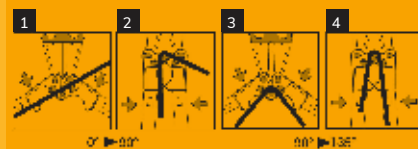

REGULACIÓN DE FILOS DE CORTE DE



CORTABULONES

ACERO
CR-V

- Apertura regulable de los filos de corte.
- Empuñadura antideslizante ergonómica.



Cód.	L mm	L "	P.V.P. unid. €	
170770	300	12	22,79	4
170772	450	18	32,18	4
170774	600	24	39,37	4
170776	750	30	51,33	2
170778	900	36	64,56	2

CAPACIDAD DE CORTE

Cód.	Ø mm blando / medio
170770	5 / 4
170772	8 / 6
170774	10 / 8
170776	13 / 10
170778	16 / 12



ALICATE DE CORTE DIAGONAL ARTICULADO

ACERO CR-V-MO

- Gran capacidad de corte con el mínimo esfuerzo.
- Mangos bimateriales y ergonómicos.
- Filos de corte templados 63 HRC.
- Terminación pavonado.
- Tope mecánico.



CAPACIDAD DE CORTE	
Alambre	Ø mm
○	6,0
◐	5,0
◑	4,0
●	3,6

Cód.	L mm	L "	P.V.P. unid. €	📦
110320	200	8	40,82	5

Se suministra con colgador.

ALICATE DE CORTE DIAGONAL ARTICULADO 35°

ACERO CR-V-MO

- Mismas características y capacidad de corte que 110320.



Especial para corte al RAS debido a la inclinación de 35° de la cabeza.



CAPACIDAD DE CORTE	
Alambre	Ø mm
○	6,0
◐	5,0
◑	4,0
●	3,6

Cód.	L mm	L "	P.V.P. unid. €	📦
110322	200	8	44,14	5

Se suministra con colgador.

ALICATE DE CORTE ARTICULADO



ACERO CR-V



CAPACIDAD DE CORTE	
Alambre	Ø mm
○	3,0
●	2,0

Cód.	L mm	L "	P.V.P. unid. €	📦
170572	200	8	18,83	6

Se suministra en blíster.

MINI CORTABULONES



ACERO CR-V

- Apertura regulable de los filos de corte.



CAPACIDAD DE CORTE	
Alambre	Ø mm
○	4,0
◐	3,0

Cód.	L mm	L "	P.V.P. unid. €	📦
170769	200	8	9,10	6

Se suministra en blíster.

CORTAALAMBRES PARA UNA MANO

ACERO CR-V

- Corte por cizalla.
- Con muelle y tope de seguridad.
- Mangos plastificados en PVC.

PARA CORTE DE ACERO



CAPACIDAD DE CORTE	
Alambre	Ø mm
○	3,0
◐	2,0
●	1,6

Cód.	L mm	L "	P.V.P. unid. €	📦
123200	180	7	29,20	1

Se suministra en blíster.

CORTAALAMBRES PARA DOS MANOS

ACERO CR-V

- Bocas forjadas intercambiables.
- Corte por cizalla.
- Mangos de aluminio inyectado. Muy ligeros.
- Elastómero antideslizante en los mangos.

PARA CORTE DE ACERO



CAPACIDAD DE CORTE	
Alambre	Ø mm
○	14
◐	12
●	10

Cód.	L mm	L "	P.V.P. unid. €	📦
123210	600	24	234,89	1

Se suministra en caja individual.

ALAMBRE DE CORTE: ○ Blando / ◐ Semiduro / ◑ Duro / ● Cuerda piano



CORTABULÓN DE FILOS INTERCAMBIABLES



- Bocas forjadas en Acero.
- Filos de corte intercambiables en Acero al CR-V dureza 56-61 HRC.
- Mangos tubulares sin soldadura.
- Elastómero antideslizante en los mangos.



Cód.	L mm	L "	P.V.P. unid. €	
123036	600	24	79,36	1
123038	900	36	133,80	1
CUCHILLA DE RECAMBIO				
123037	para Cód. 123036/123038		33,93	1



Cuchilla de recambio con 3 filos de corte útiles



123037

Cód.	CAPACIDAD DE CORTE	
	Acero 15 HRC	Acero 40 HRC
123036	13	10
123038	13	10



ALICATE CORTACABLE



- Filo de corte templado por inducción.
- Forma especial de los filos de corte. Modelo Japonés.
- Con tope mecánico.
- Mangos ergonómicos bimateriales.



**ALTA POTENCIA
40% MENOR
ESFUERZO**



No válido para cortar alambre de Acero o conductores de Cobre trenzado.

Cód.	L mm	L "	Capacidad de corte Cable Ø mm	P.V.P. unid. €	
108052	240	10	13,5	53,32	1

Se suministra con colgador.



CORTACABLES AUTOMÁTICO



- Cuerpo templado 40-48 HRC. Filos de corte templados por inducción a 58-63 HRC.
- Forma especial de los filos. Corte limpio sin deformaciones ni aplastamiento del cable.



No válido para cortar alambre de Acero o conductores de Cobre trenzado.

Cód.	L mm	L "	Capacidad de corte Cable Ø mm	P.V.P. unid. €	
108046	170	7	9,5	53,31	2
108048	230	9	13,5	63,05	2

Se suministra con colgador.



CORTACABLES PARA COBRE Y ALUMINIO DE DOS MANOS



- Cortacables para cables de aluminio/cobre sin armar.
- Con tope mecánico.
- Mangos tubulares de aluminio con fundas ergonómicas.



No válido para cortar alambre de Acero o conductores de Cobre trenzado.

CAPACIDAD DE CORTE

Cód.	L mm	L "	P.V.P. unid. €	
108055	600	24	161,98	1

Cable	Ø mm
Cobre	18
Alum	26



CORTACABLES DE CARRACA



- Filo de corte templado por inducción.
- Corte limpio sin deformación y aplastamiento.
- Cómodo manejo con una sola mano por el efecto carraca.
- Con tope mecánico.
- Mangos ergonómicos bimateriales.



CAPACIDAD DE CORTE

Cable normal	Ø mm
400 mm ²	52
MCM 750	

PARA CORTE DE CABLE DE COBRE Y ALUMINIO



No válido para cortar alambre de Acero o conductores de Cobre trenzado.

CAPACIDAD DE CORTE

Cód.	L mm	L "	P.V.P. unid. €	
108057	280	11	293,87	1

Cable de alta tensión	Ø mm
3KV CV 150x3C	46
6KV CV 100x3C	52



PELACABLES AUTOMÁTICO DE PRECISIÓN

ACERO SK5

Pelacables	Mín	Máx
Ø mm	0,5	3,2
Sección mm ²	0,2	8,0
AWG	24,0	8,0



Par de cuchillas en Acero SK5.



Colocar el cable entre las cuchillas.

Con tope de longitud para trabajos repetitivos.

Cód.	L mm	L "	P.V.P. unid. €	
108392	170	7	37,21	1

Se suministra en blíster.

Mango bicomponente.



Muelle de apertura reforzado.

Cuerpo fabricado en aleación de Zinc.



PELACABLES AUTOMÁTICO



Pelado longitudinal ajustable de 8 a 20 mm.



Precisión de pelado para cables de 0,2 a 6 mm².



Cortacables Ø máx. 2mm.

Pelacables	Mín.	Máx.
Ø mm	0,5	2,6
Sección mm ²	0,2	6,0
AWG	24,0	10,0

Cód.	L mm	L "	P.V.P. unid. €	
108390	180	7	30,11	1

Se suministra en blíster.



Cierre de seguridad para fácil almacenamiento.

Cuerpo fabricado en nylon con fibra de vidrio.



ALICATE PELACABLES MULTIFUNCIÓN

Pelacables	Mín.	Máx.
Ø mm	0,2	3,6
Sección mm ²	0,05	10,0
AWG	30,0	14,0

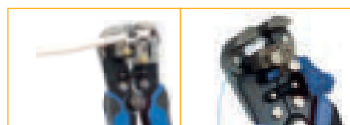

Tornillo de precisión para pelar cables muy finos.

Cód.	L mm	L "	P.V.P. unid. €	
108370	210	8	31,67	1

Se suministra en blíster.

ENGASTADOR:
Aisladas (0,5 - 6 mm²)
No aisladas (5 - 6mm²)
Autoignición (7 - 8 mm²)

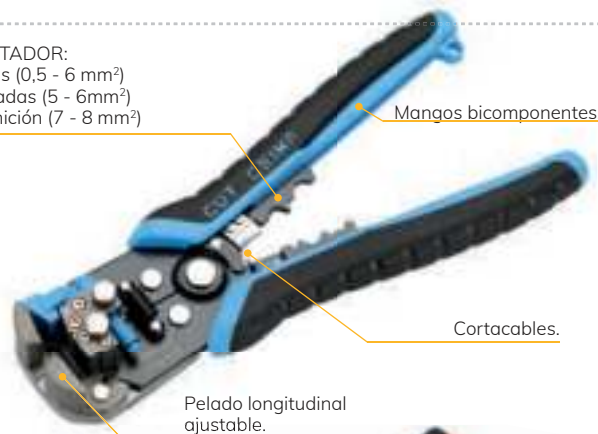

Mangos bicomponentes.

Cortacables.

Pelado longitudinal ajustable.



ALICATE PELACABLES AUTOMÁTICO

ACERO CR-V

- Pelacables 0,2-6 mm².
- Corta alambres (55-60 HRC).
- Para terminales aisladas (0,5-8 mm²).
- Para terminales no aisladas (0,5-6 mm²).

Cód.	L mm	L "	P.V.P. unid. €	
170598	250	10	20,27	6

Se suministra en blíster.

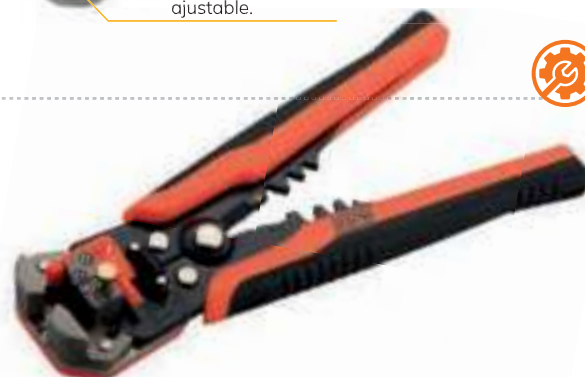



ENGASTADOR DE CARRACA PARA CONECTORES DE RED

- Cuerpo metálico tratado térmicamente.
- Con mecanismo de carraca para más fácil utilización.
- Mangos bicomponentes.

4 FUNCIONES DIFERENTES



Pelacables planos

Pelacables redondos



Corte de cables de red

Engastado de los conectores

CON FUNCIÓN DE CARRACA



PARA CONECTORES

- RJ11 6P4C
- RJ12 6P6C
- RJ45 8P8C

Cód.	L mm	P.V.P. unid. €	
108375	200	80,23	1

Se suministra en blíster.



ENGASTADOR PARA CONECTORES DE RED

FUNCIONES : Pelacables, engastador y cortacables.



Cable plano

Cable redondo

Cortacables



PARA CONECTORES

- RJ11 6P4C
- RJ12 6P6C
- RJ45 8P8C

Mango ergonómico recubierto de PVC.



Engastador.

Base de goma antideslizante y ergonómica.

Cód.	L mm	P.V.P. unid. €	
108377	140	55,82	1

Se suministra en blíster.



PELACABLES FIBRA ÓPTICA



Muesca doble en "V". Cada muesca se utiliza para cada recubrimiento del cable.



Mangos bicomponentes.

Muelle de apertura automática.



Tope de seguridad regulable.

Cód.	L mm	P.V.P. unid. €	
108075	150	26,71	1

Se suministra en blíster.

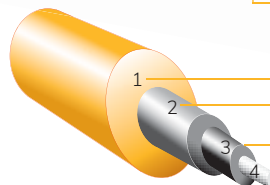

- 1 Recubrimiento exterior 2-3mm
- 2 Aislante interior 600-900µm
- 3 Funda acrílica 125-250µm
- 4 Núcleo fibra óptica



PRENSA-TERMINALES AISLADOS DE CARRACA

- Cabezas intercambiables tratadas térmicamente.
- Mecanismo para ajuste de la fuerza de prensado.
- Mecanismo de carraca para una utilización más cómoda.
- Palanca de soltado. No permite abrir la herramienta hasta finalizar el engastado si no se acciona esta palanca.

PARA TERMINALES AISLADAS
0,5 - 6 mm²



Incluida cabeza 108356

Cód.	L mm	P.V.P. unid. €	
108355	250	64,85	1

Se suministra en blíster.



PRENSA-TERMINALES NO AISLADOS DE CARRACA

- Mismas características que 108355.

PARA TERMINALES NO AISLADAS
0,5 - 6 mm²



Incluida cabeza 108361

Cód.	L mm	P.V.P. unid. €	
108360	250	57,70	1

Se suministra en blíster.



CABEZAS INTERCAMBIABLES PARA PRENSA-TERMINALES

- Fácil acoplamiento al alicate mediante dos tornillos.
- Válidas para Cód. 108355 y 108360.

Cód.	P.V.P. unid. €		Terminales aisladas 0,5-6 mm ²	Terminales no aisladas 0,5-6 mm ²	Terminales de barril 0,5-6 mm ²	Terminales coaxial BNC/TNC RG-58/RG-59/62	Terminales coaxial CATV RG-59/RG-6	Terminales tubulares 0,5-6 mm ²	Terminales tubulares 6-16 mm ²
108356	26,92	1							
108361	19,77	1							
108364	27,28	1							
108366	25,07	1							
108367	26,69	1							
108368	27,97	1							
108369	29,63	1							



JUEGO DE PRENSA-TERMINALES

COMPOSICIÓN

- 1 Alicata prensa-terminales 108355.
- 7 Cabezas intercambiables 108356 (montada), 108361, 108364, 108366, 108367, 108368, 108369.
- 1 Llave allen.
- 2 Tornillos de recambio.

Cód.	Nº piezas	P.V.P. unid. €	
108352	11	167,35	1



Medida caja: 290x230x55 mm.



PELACABLES COAXIAL

- Longitud de pelado del cable preajustado en el portacuchillas de plástico.
- Cuerpo fabricado en nylon de alta calidad.



Diseño especial para pelar cables de antena en una sola operación (RG6-RG59).



Portacuchillas con cuchillas preajustadas



- 1 Brazos de tensión
- 2 Guía del cable
- 3 Portacuchillas

03

INSTRUCCIONES DE USO

- 1 - Presionar ambos brazos de tensión e introducir el cable.
- 2 - Mantener el cable presionado con una mano a las cuchillas y con la otra girar la herramienta alrededor del cable 3 veces (el número de vueltas puede variar dependiendo del tipo de cable).

Cód.	L mm	P.V.P. unid. €	
108380	150	20,73	1

Se suministra en blíster.



ALICATE PARA TERMINALES AISLADAS-NO AISLADAS

- 1 Engastado de terminales aislados (1,5-6 mm²).
- 2 Engastado de terminales no aislados (1,5-6 mm²).
- 3 Pelacables (0,5-6 mm²).
- 4 Cortatornillos sin rebaba de M2,5 a M5.
- 5 Corte de alambre.

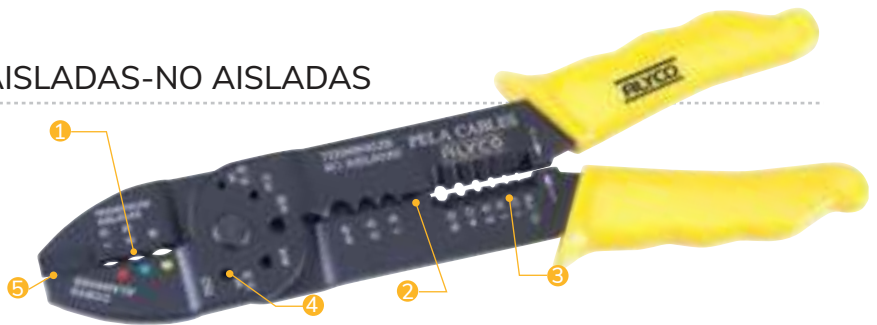

Cód.	L mm	P.V.P. unid. €	
108002	250	13,69	4

Se suministra en blíster.

PARA TERMINALES AISLADAS



PARA TERMINALES NO AISLADAS



ALICATE PARA TERMINALES NO AISLADAS

- 1 Prensa terminales no aisladas (1,5-6 mm²).
- 2 Cortador de tornillos entre M2,5 y M5.
- 3 Para utilizar con terminales de ignición.
- 4 Cortaalambre.
- 5 Pelacables (0,75-6 mm²).

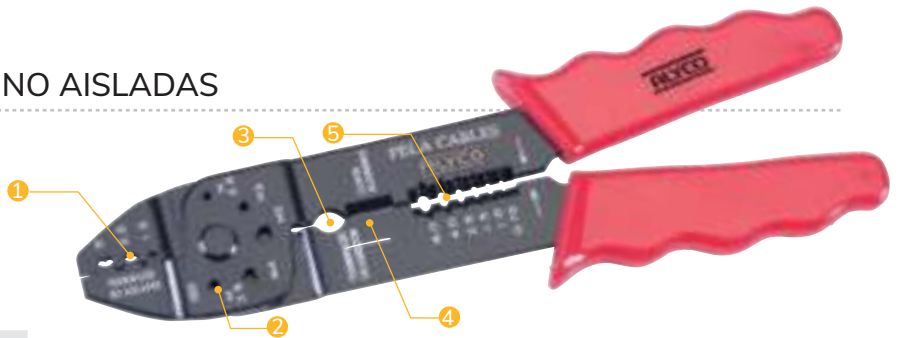

Cód.	L mm	P.V.P. unid. €	
108003	250	9,88	4

Se suministra en blíster.

PARA TERMINALES NO AISLADAS



JUEGO ALICATE PARA TERMINALES

COMPOSICIÓN

108002 / 108015 / 193369



Cód.	Nº piezas	P.V.P. unid. €	
108006	147	60,22	1



Medida caja: 375x275x55 mm



TIJERA MULTIUSOS PARA ELECTRICISTA



- Filos de corte microdentados.
- Mangos ergonómicos en nylon de gran resistencia y elastómero blando.
- Muesca pelacables.



Tijera no aislada. No utilizar en circuitos eléctricos sometidos a tensión

FILO DE CORTE 50 MM



Cód.	L mm	L "	P.V.P. unid. €	
108015	145	5,5	11,76	12

Se suministra en blíster.



TIJERA PARA ELECTRICISTA CON FUNDA

Cód.	Tipo	P.V.P. unid. €	
108215	Tijera+funda	15,18	12
108210	Funda	3,94	12

Se suministra en blíster.



Orificio para fijación de la tijera



KIT PARA ELECTRICISTA

- Bolsa de cuero reforzada con remaches en las uniones.
- Tira en la parte superior ranurada para acoplar a cinturón.

COMPOSICIÓN

- 1 Tijera 108015.
- 1 Navaja 108030.
- 1 Bolsa de cuero.



Tijera y cuchillo no aislados. No utilizar en circuitos eléctricos sometidos a tensión

Cód.	P.V.P. unid. €	
108020	23,86	6

Se suministra en blíster.



TIJERA MULTIPROFESIONAL PARA ELECTRICISTA



FILO DE CORTE 57 MM

AHORRA UN 50% DE ESFUERZO

- 1 Filos de corte microdentados.
- 2 Cortador de cables.
- 3 Prensaterminales: 2,5 / 6 mm²
- 4 Capacidad de corte: 100 mm²
- 5 Pelacables: 0,3/0,5/1,0/1,5/2,5/4,0/6,0 mm²
- 6 Seguro de cierre.



Tijera no aislada. No utilizar en circuitos eléctricos sometidos a tensión



Cód.	L mm	L "	P.V.P. unid. €	
108240	200	8	34,95	12

Se suministra en blíster.



Estructura metálica



Funda protectora

CAPACIDAD DE CORTE	
Cable Ø mm	Sección mm ²
18	100



TIJERA ELECTRICISTA REFORZADA

ACERO INOX

- Gran ergonomía de los mangos que permite una gran capacidad de corte con un mínimo esfuerzo. Ideal para trabajos repetitivos

FILO DE CORTE 40 MM

Mango en TPR (goma termoplástica).

03

CAPACIDAD DE CORTE

Cable Ø mm	Sección mm ²
15	70



Muesca pelacables de gran capacidad.



Orificio para fijación de la tijera.



Tijera no aislada. No utilizar en circuitos eléctricos sometidos a tensión

Cód.	L mm	L "	Tipo	P.V.P. unid. €	
108220	160	6,5	Tijera	20,03	12
108225	160	6,5	Tijera + Funda	21,21	12

Se suministra en blíster.



KIT PARA ELECTRICISTA REFORZADO

- Bolsa de nylon reforzada en las uniones.
- Tira en la parte superior ranurada para acoplar a cinturón.



Tijera y cuchillo no aislados. No utilizar en circuitos eléctricos sometidos a tensión

COMPOSICIÓN

- 1 Tijera 108220.
- 1 Cuchillo 108230.
- 1 Bolsa nylon.

Cód.	P.V.P. unid. €	
108235	34,48	6

Se suministra en blíster.



TIJERA PARA ELECTRICISTA REFORZADA

ACERO INOX

- Filos de corte dentados con muesca pelacables.
- Muelle de apertura automática y seguro.

FILO 60 MM



Tijera no aislada. No utilizar en circuitos eléctricos sometidos a tensión.

Cód.	L mm	P.V.P. unid. €	
108035	210	18,79	6

Se suministra en blíster.



TIJERA MULTIUSOS

ACERO INOX



108332



Cód.	L mm	P.V.P. unid. €	
108332	150	12,84	6
108337	200	16,40	6
108342	250	20,00	6

Se suministra en blíster.



TIJERA PARA ELECTRICISTA AISLADA

CERTIFICADO VDE

ACERO INOX EN 60900 DVE GS 1000 V

- Mangos bicomponentes en material aislado.
- Filos de corte templados HRC 51 ÷ 53.
- Muecas para pelar cables.

NORMA EN 60900:
Herramientas aisladas utilizadas para trabajos en tensiones de hasta 1000V en Corriente Alterna ó 1500V en Corriente Continua.

Cód.	L mm	P.V.P. unid. €	
108315	165	28,07	6

Se suministra en blíster.

FILO DE CORTE 45 MM



03



TIJERA

ACERO INOX

Tijera no aislada. No utilizar en circuitos eléctricos sometidos a tensión

Cód.	L mm	L "	P.V.P. unid. €	
108025	145	6	8,05	24

Se suministra en blíster.

FILO DE CORTE 45 MM



Filos microdentados



TIJERA MULTIFUNCIÓN

ACERO INOX

- Tijera de filos microdentados.
- Cuchillo.
- Pelador.
- Abre botellas.
- Aplastador

Cód.	L mm	L "	P.V.P. unid. €	
171300	225	9	9,06	12

Se suministra en blíster.

FILO DE CORTE 60 MM



Funda magnética



Desmontable



Filos microdentados



TIJERA MULTIUSOS

ACERO INOX

Cód.	L mm	L "	P.V.P. unid. €	
171310	210	8	5,27	12

Se suministra en blíster.

FILO DE CORTE 75 MM



Funda magnética





CUCHILLO PELACABLES

ACERO INOX



Protector plástico de la hoja para evitar cortes accidentales, apoyar el cable a la hora de cortar y utilizar como pelacables.

MODO DE USO



FILO DE CORTE 50 MM

Cuchillo no aislado. No utilizar en circuitos eléctricos sometidos a tensión.

CAPACIDAD DE CORTE	
Cable Ø mm	Sección mm ²
30	120

Cód.	L mm	P.V.P. unid. €	
108230	200	11,79	12

Se suministra en blíster.



CUCHILLO PARA ELECTRICISTA

ACERO INOX

- Hoja de 2,5mm de espesor pulida.
- Filo de corte endurecido a 57-60 HRC.
- Mango fabricado en nylon de gran resistencia.



FILO DE CORTE 45 MM

Cuchillo no aislado. No utilizar en circuitos eléctricos sometidos a tensión.

Cód.	L mm	P.V.P. unid. €	
108030	155	7,63	12



CUCHILLO PELAMANGUERAS AISLADO PARA ELECTRICISTA

ACERO CR-V

EN 60900



CERTIFICADO VDE

- Mango recubierto de material aislante con tope de seguridad.
- Doble filo de corte, curvo y recto.
- La uña no daña al conductor.

FILO DE CORTE 40 MM



Cód.	L mm	P.V.P. unid. €	
108095	200	23,35	6

Se suministra en blíster.



CUCHILLO AISLADO PARA ELECTRICISTA

ACERO CR-V

EN 60900



CERTIFICADO VDE

- Mango recubierto de material aislante con tope de seguridad.

FILO DE CORTE 50 MM



Cód.	L mm	P.V.P. unid. €	
108090	200	17,05	6

Se suministra en blíster.



NAVAJA PARA ELECTRICISTA

ACERO INOX

- Hoja de 2,5 mm de espesor.
- Filo de corte liso y dentado.
- Doble muesca para pelar cables.
- Mango ergonómico bimaterial.

FILO DE CORTE 65 MM



Navaja no aislada. No utilizar en circuitos eléctricos sometidos a tensión.

Cód.	L abierta mm	L cerrada mm	P.V.P. unid. €	
108032	210	120	14,78	12

Se suministra en blíster.



NAVAJA DE MANGO DE ALUMINIO

ACERO INOX

- Hoja en Acero inoxidable templado.
- Mango de aluminio anodizado y plástico duro antideslizante.
- Sistema de bloqueo de la hoja en posición abierta.

FILO DE CORTE 85 MM



Clip metálico

Cód.	L abierta mm	L cerrada mm	P.V.P. unid. €	
101272	190	115	14,37	6

Se suministra en blíster.



NAVAJA CON MANGO DE MADERA



- Hoja de acero inoxidable especialmente resistente a la corrosión.
- Mangos ergonómicos fabricados en madera de palisandro de gran resistencia.
- Sistema de bloqueo de la hoja en posición abierta.

FILO DE CORTE
70 MM



Navaja no aislada. No utilizar en circuitos eléctricos sometidos a tensión.

Cód.	L abierta mm	L cerrada mm	P.V.P. unid. €	
101277	166	95	12,42	6



NAVAJA CON MANGO DE MADERA



- Hoja de acero inoxidable especialmente resistente a la corrosión.
- Mangos ergonómicos fabricados en madera de palisandro de gran resistencia.
- Sistema de bloqueo de la hoja en posición abierta.

FILO DE CORTE
85 MM



Navaja no aislada. No utilizar en circuitos eléctricos sometidos a tensión.

Cód.	L abierta mm	L cerrada mm	P.V.P. unid. €	
101279	194	110	14,40	6



NAVAJA CON MANGO DE MADERA



- Hoja de acero inoxidable especialmente resistente a la corrosión.
- Mangos ergonómicos fabricados en madera de palisandro de gran resistencia.
- Sistema de bloqueo de la hoja en posición abierta.

FILO DE CORTE
82 MM



Navaja no aislada. No utilizar en circuitos eléctricos sometidos a tensión.

Cód.	L abierta mm	L cerrada mm	P.V.P. unid. €	
101278	196	116	13,25	6



NAVAJA CON MANGO DE MADERA



- Hoja de acero inoxidable especialmente resistente a la corrosión.
- Mangos ergonómicos fabricados en madera de palisandro de gran resistencia.
- Sistema de bloqueo de la hoja en posición abierta.

FILO DE CORTE
60 MM



Navaja no aislada. No utilizar en circuitos eléctricos sometidos a tensión.

Cód.	L abierta mm	L cerrada mm	P.V.P. unid. €	
101280	150	89	14,00	6



EXPOSITOR DE 24 NAVAJAS CON MANGO DE MADERA



- Las navajas se suministran en un atractivo expositor de sobremesa fácil de montar.

COMPOSICIÓN

- 101277 x 6 uds.
- 101278 x 6 uds.
- 101279 x 6 uds.
- 101280 x 6 uds.

Cód.	Nº Piezas	P.V.P. unid. €	
101282	24	329,20	1



03



NAVAJA EN BOLSA DE NYLON

ACERO INOX

- Cuerpo de Aluminio con refuerzo interior metálico.
- Zona de contacto con la mano recubierta de madera.
- Forma ergonómica.
- Clip metálico en la parte posterior.
- Sistema de bloqueo de la hoja en posición abierta.
- Se suministra en bolsa de nylon individual.

FILO DE CORTE 85 MM



Clip metálico

Bolsa de nylon

Navaja no aislada. No utilizar en circuitos eléctricos sometidos a tensión.

Cód.	L abierta mm	L cerrada mm	P.V.P. unid. €	
101270	205	120	17,24	6

Se suministra en blíster y expositor.



NAVAJA PARA ELECTRICISTA DE DOBLE HOJA

ACERO INOX

FILO DE CORTE 60 MM



Navaja no aislada. No utilizar en circuitos eléctricos sometidos a tensión.

Cód.	L abierta mm	L cerrada mm	P.V.P. unid. €	
101276	210	110	13,03	6

Se suministra en blíster.



NAVAJA PARA ELECTRICISTA MANGO MADERA

ACERO INOX

FILO DE CORTE 60 MM



Navaja no aislada. No utilizar en circuitos eléctricos sometidos a tensión.

Code	L abierta mm	L cerrada mm	P.V.P. unid. €	
101274	210	110	10,32	6

Se suministra en blíster.



NAVAJA CON MANGO DE ALUMINIO

ACERO INOX

- Clip metálico posterior.
- Mango aluminio anodizado.
- Longitud abierta: 190 mm.
- Longitud plegada: 110 mm.
- Seguro de cierre.

FILO 85 MM



Cód.	P.V.P. unid. €	
170890	11,94	6

Se suministra en blíster.

Navaja no aislada. No utilizar en circuitos eléctricos sometidos a tensión.



NAVAJA PARA ELECTRICISTA

ACERO INOX

- Doble muesca pelacables.
- Mango aluminio anodizado.
- Longitud abierta: 190 mm.
- Longitud plegada: 110 mm.
- Seguro de cierre.

FILO 65 MM



Cód.	P.V.P. unid. €	
170895	12,18	6

Se suministra en blíster.

Navaja no aislada. No utilizar en circuitos eléctricos sometidos a tensión.



TIJERA CORTACHAPAS ARTICULADA CORTE RECTO

ACERO CR-Mo



- Bocas forjadas.
- Muelle de brazos que automatiza la apertura.
- Filos dentados endurecidos, antideslizantes.
- Sistema articulado que multiplica el esfuerzo.
- Cierre de seguridad.
- Mangos ergonómicos bimateriales.



CAPACIDAD DE CORTE

Chapa	Grosor mm
Cobre	1,5
Acero laminado	1,2
Acero HRC30	1,0

Cód.	L mm	L "	P.V.P. unid. €	
108100	250	10	18,97	6

Se suministra en blíster.



TIJERA CORTACHAPAS ACODADA CORTE A IZQUIERDA

ACERO CR-Mo



- Mismas características que cód. 108100

TIJERA REFORZADA



Cód.	L mm	L "	P.V.P. unid. €	
108110	250	10	21,64	6

Se suministra en blíster.



TIJERA CORTACHAPAS ACODADA CORTE A DERECHA

ACERO CR-Mo



- Mismas características que cód. 108100

TIJERA REFORZADA



Cód.	L mm	L "	P.V.P. unid. €	
108120	250	10	21,64	6

Se suministra en blíster.



TIJERA CORTACHAPAS CORTE RECTO BOCA LARGA

ACERO SK5



Cód.	L mm	L "	P.V.P. unid. €	
108105	300	12	20,12	6

Se suministra en blíster.



TIJERA PARA CHAPA MODELO MADRID

- Bocas forjadas en Acero.
- Con tope superior.
- Presentación pintado, bocas pulidas.



Cód.	L mm	L "	P.V.P. unid. €	
108300	250	10	20,16	6
108302	300	12	27,29	6

Se suministra en blíster.



TIJERA CORTACHAPAS ARTICULADA CORTE RECTO



ACERO CR-V



- Filos dentados y templados a 55÷58 HRC.
- Cierre de seguridad.



Cód.	L mm	L "	P.V.P. unid. €	
170880	250	10	10,94	6

Se suministra en colgador.

03



TIJERA CORTACHAPAS ACODADA CORTE A IZQUIERDA



ACERO CR-V



- Filos dentados y templados a 55÷58 HRC.
- Cierre de seguridad.



Cód.	L mm	L "	P.V.P. unid. €	
170896	250	10	11,06	6

Se suministra en colgador.



TIJERA CORTACHAPAS ACODADA CORTE A DERECHA



ACERO CR-V



- Filos dentados y templados a 55÷58 HRC.
- Cierre de seguridad.



Cód.	L mm	L "	P.V.P. unid. €	
170898	250	10	11,06	6

Se suministra en colgador.



PELAMANGUERAS

- Uña extractora exterior.
- Tornillo para ajuste de la profundidad de corte.



INCLUYE:



Cód.	L mm	Ø Pelado mm	P.V.P. unid. €	
108080	190	8-28	23,15	1
CUCHILLA DE RECAMBIO				
108081	para código 108080		7,04	1

Se suministra en blíster.



PELAMANGUERAS

- Palanca de giro 90° de la cuchilla. Corte longitudinal.
- Regulación de profundidad de corte por giro de la cabeza.



INCLUYE:



Cód.	L mm	Ø Pelado mm	P.V.P. unid. €	
108085	140	8-28	26,92	1
CUCHILLA DE RECAMBIO				
108086	para código 108085		7,50	1

Se suministra en blíster.

04

LLAVES

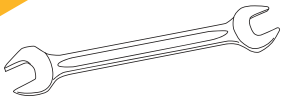

Llave fija de dos bocas **120**

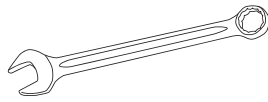

Llave combinada **123**

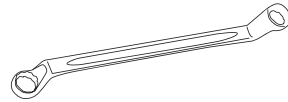

Llave de estrella acodada **126**

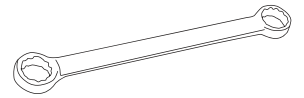

Llave de estrella plana **129**

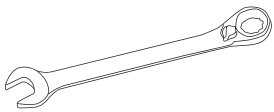

Llave combinada con carraca **130**

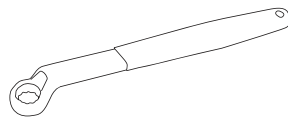

Llave aislada **136**

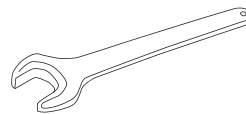

Llave fija de una boca **137**

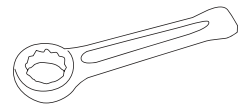

Llave de golpe **138**

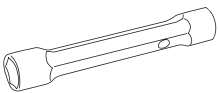

Llave de tubo **139**

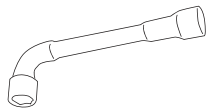

Llave de pipa **141**

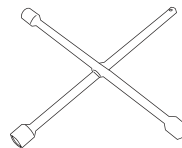

Llave para ruedas **142**

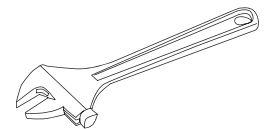

Llave ajustable **143**

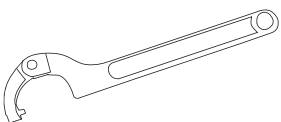

Llave articulada **145**

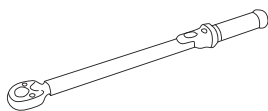

Llave dinamométrica **147**



LLAVE FIJA DE 2 BOCAS

DIN 3110

ACERO CR-V

- Acodada de 30° para acceso a lugares difíciles.
- Bocas con chaflán para un fácil encaje en la tuerca.
- Terminación en cromado satinado mate.
- Cabezas pulidas.

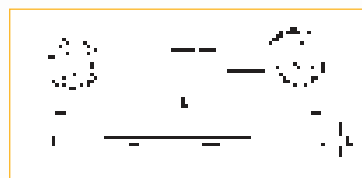

04

Cód.	Ø mm	L mm	E mm	P.V.P. unid. €		Cód.	Ø mm	L mm	E mm	P.V.P. unid. €	
191004	4x5	103	3,2	3,27	10	191045	21x23	245	7,7	7,92	5
191005	6x7	122	3,5	3,39	10	191047	22x24	245	7,7	8,11	5
191010	8x9	136	3,7	3,53	10	191050	24x26	265	8,7	9,30	5
191015	10x11	151	4,7	3,70	10	191055	24x27	265	8,7	9,53	5
191012	10x13	171	5,0	4,36	10	191060	25x28	274	8,7	10,58	5
191020	12x13	171	5,2	4,54	10	191065	27x29	278	8,4	12,26	5
191028	13x17	186	5,7	5,62	10	191070	30x32	299	9,7	14,38	5
191025	14x15	186	5,7	4,82	10	191072	32x36	330	9,6	23,72	2
191030	16x17	201	6,2	5,70	10	191073	34x36	330	9,6	24,89	2
191033	17x19	220	7,2	6,18	10	191075	36x41	358	9,8	27,75	5
191035	18x19	220	7,2	6,24	10	191076	41x46	405	10,3	41,11	2
191038	19x22	235	7,7	7,32	5	191077	46x50	455	10,8	51,38	2
191040	20x22	235	7,7	7,67	5						

Se suministra en colgador hasta la medida 30x32 mm (incluida).



LLAVE FIJA DE 2 BOCAS EN PULGADAS

DIN 3110

ACERO CR-V

- Acodada de 30° para acceso a lugares difíciles.
- Bocas con chaflán para un fácil encaje en la tuerca.
- Terminación en cromado satinado mate.
- Cabezas pulidas.

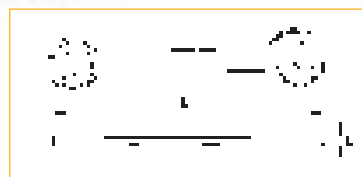

Cód.	Ø"	L mm	E mm	P.V.P. unid. €		Cód.	Ø"	L mm	E mm	P.V.P. unid. €	
190002	1/4"x5/16"	122	3,5	3,39	1	190018	3/4"x7/8"	235	7,7	6,63	1
190004	5/16"x3/8"	136	3,7	3,53	1	190020	13/16"x7/8"	235	7,7	7,93	1
190006	3/8"x7/16"	151	4,7	3,70	1	190022	15/16"x1"	265	8,7	9,30	1
190008	7/16"x1/2"	171	5,2	4,54	1	190024	1"x1-1/8"	274	8,7	10,58	1
190010	1/2"x9/16"	186	5,7	4,82	1	190026	1-1/8"x1-5/16"	299	9,7	13,18	1
190012	9/16"x5/8"	186	5,7	5,09	1	190028	1-1/16"x1-1/4"	299	9,0	14,38	1
190014	5/8"x11/16"	201	6,2	5,70	1	190030	1-7/16"x1-5/8"	358	9,8	27,71	1
190016	11/16"x3/4"	220	7,2	6,24	1						

 **JUEGO DE LLAVES FIJAS, CAJA DE CARTÓN**

COMPOSICIÓN

8x9, 10x11, 12x13, 14x15, 16x17, 18x19 mm.



Cód.	Nº piezas	P.V.P. unid. €	
191082	6	28,52	1

 **JUEGO DE LLAVES FIJAS, CAJA DE CARTÓN**

COMPOSICIÓN

6x7, 8x9, 10x11, 12x13, 14x15, 16x17, 18x19, 20x22 mm.



Cód.	Nº piezas	P.V.P. unid. €	
191080	8	39,23	1

04

 **JUEGO DE LLAVES FIJAS, BOLSA DE NYLON**

COMPOSICIÓN

191081: 6x7, 8x9, 10x11, 12x13, 14x15, 16x17, 18x19, 20x22 mm.

190040: 1/4"x5/16", 5/16"x3/8", 3/8"x7/16", 1/2"x9/16", 9/16"x5/8", 5/8"x11/16", 11/16"x3/4", 3/4"x7/8".



191081



190040

 **JUEGO DE LLAVES FIJAS, BOLSA DE NYLON**

COMPOSICIÓN

191086: 6x7, 8x9, 10x11, 12x13, 14x15, 16x17, 18x19, 20x22, 21x23, 24x27, 25x28, 30x32 mm.

190045: 1/4"x5/16", 5/16"x3/8", 3/8"x7/16", 1/2"x9/16", 9/16"x5/8", 5/8"x11/16", 11/16"x3/4", 3/4"x7/8", 13/16"x7/8", 15/16"x1", 1"x1-1/8", 1-1/16"x1-1/4".



191086



190045

Cód.	Nº piezas	P.V.P. unid. €	
191081	8	39,31	1
190040	8	39,31	1 

Cód.	Nº piezas	P.V.P. unid. €	
191086	12	81,35	1
190045	12	81,35	1 

 **JUEGO DE LLAVES FIJAS, SOPORTE DE PLÁSTICO**

COMPOSICIÓN

6x7, 8x9, 10x11, 12x13, 14x15, 16x17, 18x19, 20x22, 21x23, 24x27, 25x28, 30x32 mm.



Cód.	Nº piezas	P.V.P. unid. €	
191085	12	82,18	1

 **JUEGO DE LLAVES FIJAS, CAJA DE PLÁSTICO**

COMPOSICIÓN

6x7, 8x9, 10x11, 12x13, 14x15, 16x17, 18x19, 20x22 mm.



Medida caja: 255x185x48 mm.

Cód.	Nº piezas	P.V.P. unid. €	
191096	8	39,18	1



LLAVE FIJA DE 2 BOCAS



DIN 3110

ACERO CR-V

- Bocas pulidas.
- Terminación cromado brillante.



04

Cód.	mm	P.V.P. unid. €		Cód.	mm	P.V.P. unid. €		Cód.	mm	P.V.P. unid. €	
170003	6x7	1,39	10	170014	16x17	2,63	10	170024	25x28	8,57	5
170004	8x9	1,38	10	170016	18x19	4,13	10	170027	27x29	9,50	5
170005	10x11	1,86	10	170018	20x22	5,17	5	170026	30x32	10,62	5
170007	12x13	2,19	10	170019	21x23	6,26	5	170030	36x41	18,02	5
170011	14x15	2,18	10	170021	24x26	7,39	5				

Se suministra con colgador.



JUEGO DE LLAVES FIJAS, SOPORTE DE PLÁSTICO



COMPOSICIÓN

6x7, 8x9, 10x11, 12x13, 14x15, 16x17, 18x19, 20x22 mm.



Cód.	Nº Piezas	P.V.P. unid. €	
170080	8	20,43	4



JUEGO DE LLAVES FIJAS, SOPORTE DE PLÁSTICO



COMPOSICIÓN

6x7, 8x9, 10x11, 12x13, 14x15, 16x17, 18x19, 20x22, 21x23, 24x26 mm.



Cód.	Nº Piezas	P.V.P. unid. €	
170081	10	33,63	2



JUEGO DE LLAVES FIJAS, SOPORTE DE PLÁSTICO



COMPOSICIÓN

6x7, 8x9, 10x11, 12x13, 14x15, 16x17, 18x19, 20x22, 21x23, 24x26, 25x28, 30x32 mm.



Cód.	Nº Piezas	P.V.P. unid. €	
170082	12	52,82	2



JUEGO DE LLAVES FIJAS, BOLSA DE NYLON



COMPOSICIÓN

6x7, 8x9, 10x11, 12x13, 14x15, 16x17, 18x19, 20x22, 21x23, 24x26, 25x28, 30x32 mm.



Cód.	Nº Piezas	P.V.P. unid. €	
170086	12	53,51	1



LLAVE COMBINADA

DIN 3113

ACERO CR-V



- Terminación en cromado satinado mate.
- Cabezas pulidas.

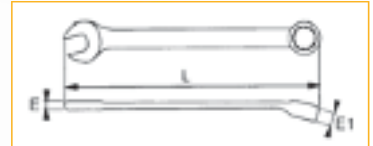

04

Cód.	mm	L mm	E mm	E1 mm	P.V.P. unid. €		Cód.	mm	L mm	E mm	E1 mm	P.V.P. unid. €	
191203	6	100	3,5	5,4	4,47	10	191251	22	260	8,7	13,8	11,31	5
191206	7	110	3,5	6,4	4,53	10	191254	23	270	8,9	14,3	12,08	5
191209	8	120	4,0	6,4	4,58	10	191257	24	280	8,9	14,8	12,60	5
191212	9	130	4,0	6,9	5,35	10	191260	25	290	9,2	15,3	13,57	5
191215	10	140	4,5	8,4	5,42	10	191263	26	300	9,2	15,8	16,54	5
191218	11	150	5,0	9,4	5,94	10	191266	27	310	9,7	16,3	17,84	5
191221	12	160	5,0	9,4	6,26	10	191269	28	320	9,7	16,8	18,98	5
191224	13	170	5,9	10,4	6,65	10	191272	29	330	9,9	17,3	19,16	5
191227	14	180	5,9	10,9	6,86	5	191275	30	340	10,2	17,3	19,45	5
191230	15	190	5,9	10,9	7,10	5	191278	32	360	10,2	17,6	21,76	5
191233	16	200	6,3	11,9	7,59	5	191279	34	380	10,2	17,6	24,51	2
191236	17	210	6,5	11,9	8,10	5	191281	36	399	14,0	21,8	36,11	2
191239	18	220	6,7	12,9	8,56	5	191282	41	442	15,0	22,8	44,85	2
191242	19	230	7,2	12,9	9,69	5	191283	46	492	16,0	25,8	57,27	2
191245	20	240	7,7	13,3	9,86	5	191284	50	531	17,0	25,8	66,50	2
191248	21	250	8,2	13,8	11,15	5							



LLAVE COMBINADA EN PULGADAS

DIN 3113

ACERO CR-V



- Terminación en cromado satinado mate.
- Cabezas pulidas.

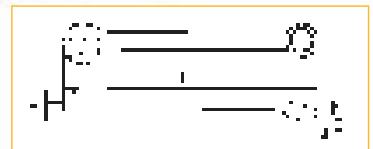

Cód.	"	L mm	E mm	E1 mm	P.V.P. unid. €		Cód.	"	L mm	E mm	E1 mm	P.V.P. unid. €	
190100	1/4"	100	3,5	5,4	4,47	1	190118	3/4"	230	7,2	12,9	9,69	1
190102	5/16"	120	4,0	6,4	4,58	1	190120	13/16"	250	8,2	13,8	11,15	1
190104	11/32"	130	4,0	6,9	5,36	1	190122	7/8"	260	8,7	13,8	11,31	1
190106	3/8"	140	4,5	8,4	5,42	1	190124	15/16"	280	8,9	14,8	12,60	1
190108	7/16"	150	5,0	9,4	5,94	1	190126	1"	290	9,2	15,3	13,57	1
190110	1/2"	170	5,9	10,4	6,65	1	190128	1-1/16"	310	9,7	16,3	17,84	1
190112	9/16"	180	5,9	10,9	6,86	1	190130	1-1/8"	330	9,9	17,3	19,00	1
190114	5/8"	200	6,3	11,9	8,09	1	190132	1-1/4"	360	10,2	17,6	21,76	1
190116	11/16"	210	6,5	11,9	9,18	1							



JUEGO DE LLAVES COMBINADAS, CAJA DE CARTÓN

COMPOSICIÓN

8, 10, 11, 12, 13, 14, 17, 19 mm.



Cód.	Nº piezas	P.V.P. unid. €	
191280	8	53,50	1



JUEGO DE LLAVES COMBINADAS, BOLSA DE NYLON

COMPOSICIÓN

Todas las medidas entre 6 y 32, excepto 31 mm.



Cód.	Nº piezas	P.V.P. unid. €	
191286	26	269,83	1



JUEGO DE LLAVES COMBINADAS, BOLSA DE NYLON

COMPOSICIÓN

1/4", 5/16", 3/8", 7/16", 1/2", 9/16", 5/8", 11/16".



Cód.	Nº piezas	P.V.P. unid. €	
190140	8	51,14	1



JUEGO DE LLAVES COMBINADAS, BOLSA DE NYLON

COMPOSICIÓN

3/8", 7/16", 1/2", 9/16", 5/8", 11/16", 3/4", 13/16", 7/8", 15/16", 1", 1-1/16".



Cód.	Nº piezas	P.V.P. unid. €	
190145	12	117,17	1



JUEGO DE LLAVES COMBINADAS, CAJA DE PLÁSTICO

COMPOSICIÓN

8, 10, 11, 12, 13, 14, 17, 19 mm.



Medida caja: 255x185x48mm.

Cód.	Nº piezas	P.V.P. unid. €	
191296	8	54,13	1



LLAVE COMBINADA



- Bocas pulidas.
- Terminación cromado brillante.



Cód.	mm	P.V.P. unid. €		Cód.	mm	P.V.P. unid. €		Cód.	mm	P.V.P. unid. €	
170101	6	1,30	10	170111	16	2,58	5	170121	26	8,99	5
170102	7	1,39	10	170112	17	2,86	5	170122	27	11,00	5
170103	8	1,58	10	170113	18	2,91	5	170123	28	11,75	5
170104	9	1,66	10	170114	19	3,08	5	170124	29	12,19	5
170105	10	1,78	10	170115	20	3,66	5	170125	30	13,77	5
170106	11	1,79	10	170116	21	3,95	5	170126	32	17,28	5
170107	12	1,83	10	170117	22	4,81	5	170127	34	19,47	2
170108	13	2,29	5	170118	23	6,94	5	170128	36	24,77	2
170109	14	2,41	5	170119	24	7,64	5				
170110	15	2,47	5	170120	25	8,17	5				

04



JUEGO DE LLAVES COMBINADAS, SOPORTE DE PLÁSTICO



COMPOSICIÓN

8, 9, 10, 11, 13, 14, 17, 19 mm.



Cód.	Nº piezas	P.V.P. unid. €	
170180	8	17,47	4



JUEGO DE LLAVES COMBINADAS, SOPORTE DE PLÁSTICO



COMPOSICIÓN

6, 7, 8, 9, 10, 11, 12, 13, 14, 17, 19, 22 mm.



Cód.	Nº piezas	P.V.P. unid. €	
170182	12	25,46	2



JUEGO DE LLAVES COMBINADAS, SOPORTE DE PLÁSTICO



COMPOSICIÓN

6, 7, 8, 9, 10, 11, 12, 13, 14, 15, 16, 17, 18, 19, 20, 21, 22 mm.



Cód.	Nº piezas	P.V.P. unid. €	
170183	17	39,43	2



JUEGO DE LLAVES COMBINADAS, BOLSA DE NYLON



COMPOSICIÓN

Todas las medidas entre 6 y 32, excepto 31mm.



Cód.	Nº piezas	P.V.P. unid. €	
170184	26	136,24	1



LLAVE DE ESTRELLA ACODADA



- Terminación en cromado satinado mate.
- Cabezas pulidas.

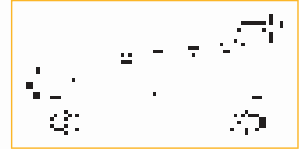

04

Cód.	mm	L mm	E mm	E1 mm	P.V.P. unid. €		Cód.	mm	L mm	E mm	E1 mm	P.V.P. unid. €	
191105	6x7	167	5,5	6,0	6,45	10	191145	21x23	325	12,2	13,0	15,45	5
191110	8x9	182	6,0	7,0	7,05	10	191148	22x24	325	12,2	13,0	15,86	5
191115	10x11	197	7,5	8,0	7,53	10	191150	24x26	337	13,0	14,0	19,18	5
191120	12x13	216	8,5	9,1	7,96	10	191155	24x27	337	13,0	14,0	19,18	5
191128	13x17	263	10,3	10,7	8,64	10	191160	25x28	346	13,2	14,5	22,28	5
191125	14x15	239	9,7	10,7	10,02	10	191165	27x29	346	14,2	15,5	23,65	5
191130	16x17	263	10,3	10,7	10,26	10	191170	30x32	360	15,2	16,5	26,98	5
191133	17x19	290	11,0	11,3	11,77	10	191172	32x36	410	16,0	17,5	42,00	2
191135	18x19	290	11,0	11,3	11,86	10	191175	36x41	440	17,5	19,0	50,16	2
191138	19x22	317	11,7	12,4	13,69	5	191177	46x50	515	22,0	23,5	81,62	2
191140	20x22	317	11,7	12,4	13,69	5							



LLAVE DE ESTRELLA ACODADA



- Terminación en cromado satinado mate.
- Cabezas pulidas.



Cód.	"	L mm	E mm	E1 mm	P.V.P. unid. €		Cód.	"	L mm	E mm	E1 mm	P.V.P. unid. €	
190050	1/4"x5/16"	167	5,5	6,0	6,45	1	190066	3/4"x7/8"	317	11,7	12,4	12,88	1
190052	5/16"x3/8"	182	6,0	7,0	7,05	1	190068	13/16"x7/8"	317	11,7	12,4	13,68	1
190054	3/8"x7/16"	197	7,5	8,0	7,53	1	190070	13/16"x15/16"	325	12,2	13,0	15,45	1
190056	7/16"x1/2"	216	8,5	9,1	7,96	1	190072	15/16"x1"	337	13,0	14,0	19,18	1
190058	1/2"x9/16"	239	9,7	10,7	8,64	1	190074	1"x1-1/8"	346	13,2	14,5	22,28	1
190060	9/16"x5/8"	239	9,7	10,7	9,65	1	190076	1-1/16"x1-1/4"	360	15,0	16,5	23,65	1
190062	5/8"x11/16"	263	10,3	10,7	10,26	1	190078	1-1/8"x1-1/4"	360	15,2	16,5	24,60	1
190064	11/16"x3/4"	290	11,0	11,3	11,86	1							

 **JUEGO DE LLAVES ACODADAS, CAJA DE CARTÓN**

COMPOSICIÓN

8x9, 10x11, 12x13, 14x15, 16x17, 18x19 mm.



Cód.	Nº piezas	P.V.P. unid. €	
191182	6	53,31	1

 **JUEGO DE LLAVES ACODADAS, CAJA DE CARTÓN**

COMPOSICIÓN

6x7, 8x9, 10x11, 12x13, 14x15, 16x17, 18x19, 20x22 mm.



Cód.	Nº piezas	P.V.P. unid. €	
191180	8	73,46	1

04

 **JUEGO DE LLAVES ACODADAS, BOLSA DE NYLON**

COMPOSICIÓN

191181: 6x7, 8x9, 10x11, 12x13, 14x15, 16x17, 18x19, 20x22 mm.

190090: 1/4"x5/16", 5/16"x3/8", 3/8"x7/16", 7/16"x1/2", 1/2"x9/16", 5/8"x11/16", 3/4"x7/8", 11/16"x3/4".



191181



190090

Cód.	Nº piezas	P.V.P. unid. €	
191181	8	73,81	1
190090	8	72,67	1 

 **JUEGO DE LLAVES ACODADAS, BOLSA DE NYLON**

COMPOSICIÓN

191185: 6x7, 8x9, 10x11, 12x13, 14x15, 16x17, 18x19, 20x22, 21x23, 24x27, 25x28, 30x32 mm.

190095: 1/4"x5/16", 5/16"x3/8", 3/8"x7/16", 7/16"x1/2", 1/2"x9/16", 9/16"x5/8", 5/8"x11/16", 3/4"x7/8", 13/16"x7/8", 15/16"x1", 1-1/16"x1-1/4", 1-1/8"x1-1/4".



191185



190095

Cód.	Nº piezas	P.V.P. unid. €	
191185	12	157,47	1
190095	12	151,56	1 



LLAVE DE ESTRELLA ACODADA



- Bocas pulidas.
- Terminación cromado brillante.



04

Cód.	mm	P.V.P. unid. €		Cód.	mm	P.V.P. unid. €		Cód.	mm	P.V.P. unid. €	
170203	6x7	2,33	10	170214	16x17	4,23	10	170221	25x28	10,17	5
170204	8x9	2,74	10	170215	18x19	4,54	10	170223	27x29	11,47	5
170206	10x11	2,97	10	170217	20x22	5,20	5	170222	30x32	12,94	2
170208	12x13	3,00	10	170218	21x23	7,22	5	170224	36x41	30,35	2
170212	14x15	3,36	10	170220	24x26	8,36	5				



JUEGO DE LLAVES ACODADAS, SOPORTE DE PLÁSTICO



JUEGO DE LLAVES ACODADAS, SOPORTE DE PLÁSTICO



COMPOSICIÓN

6x7, 8x9, 10x11, 12x13, 14x15, 16x17, 18x19, 20x22 mm.



Cód.	Nº piezas	P.V.P. unid. €	
170280	8	25,84	4

COMPOSICIÓN

6x7, 8x9, 10x11, 12x13, 14x15, 16x17, 18x19, 20x22, 21x23, 24x26, 25x28, 30x32 mm.



Cód.	Nº piezas	P.V.P. unid. €	
170282	12	58,71	2



JUEGO DE LLAVES ACODADAS, BOLSA DE NYLON



COMPOSICIÓN

6x7, 8x9, 10x11, 12x13, 14x15, 16x17, 18x19, 20x22, 21x23, 24x26, 25x28, 30x32 mm.

Cód.	Nº piezas	P.V.P. unid. €	
170284	12	59,40	1





LLAVE DE ESTRELLA PLANA



- Terminación en cromado satinado mate.
- Cabezas pulidas.

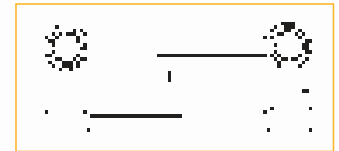

04

Cód.	mm	L mm	P.V.P. unid. €	
191305	6x7	99	7,17	10
191310	8x9	114	7,93	10
191315	10x11	130	8,11	10
191320	12x13	145	8,80	10
191325	14x15	160	9,79	10
191330	16x17	170	11,05	10
191335	18x19	185	12,07	10

Cód.	mm	L mm	P.V.P. unid. €	
191340	20x22	205	14,33	5
191345	21x23	230	17,10	5
191350	24x26	260	18,79	5
191355	25x28	270	21,04	5
191357	27x29	320	22,78	5
191360	30x32	320	24,47	5



JUEGO DE LLAVES DE ESTRELLA PLANAS, BOLSA DE NYLON

COMPOSICIÓN

6x7, 8x9, 10x11, 12x13, 14x15, 16x17, 18x19, 20x22 mm.

Cód.	Nº piezas	P.V.P. unid. €	
191396	8	79,27	1



JUEGO DE LLAVES DE ESTRELLA PLANAS, BOLSA DE NYLON

COMPOSICIÓN

6x7, 8x9, 10x11, 12x13, 14x15, 16x17, 18x19, 20x22, 21x23, 24x26, 25x28, 30x32 mm.

Cód.	Nº piezas	P.V.P. unid. €	
191397	12	160,68	1





LLAVE COMBINADA CON CARRACA REVERSIBLE

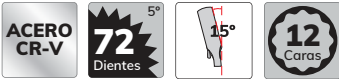

- Acodado de 15° en la cabeza.
- Carraca reversible de 72 dientes.
- Terminación en cromado satinado mate.
- Cabezas pulidas.



04

ADAPTADORES ACOPLABLES
EN PÁG. 133

Cód.	mm	L mm	P.V.P. unid. €		Cód.	mm	L mm	P.V.P. unid. €		Cód.	mm	L mm	P.V.P. unid. €	
191805	8	136	14,16	5	191840	15	200	18,82	5	191865	23	285	32,32	5
191810	9	143	14,23	5	191845	16	216	19,92	5	191866	24	324	33,97	5
191815	10	159	14,29	5	191850	17	233	20,92	5	191891	26	325	36,43	5
191820	11	168	14,70	5	191855	18	239	22,48	5	191868	27	359	46,76	5
191825	12	174	15,71	5	191860	19	248	23,06	5	191869	28	359	49,50	5
191830	13	180	17,27	5	191862	21	284	28,99	5	191870	30	425	56,44	5
191835	14	190	18,38	5	191864	22	284	29,83	5	191872	32	425	57,78	5



JUEGO DE LLAVES COMBINADAS CON CARRACA REVERSIBLE, SOPORTE DE PLÁSTICO

COMPOSICIÓN

8, 10, 13, 17, 19 mm.



Cód.	Nº piezas	P.V.P. unid. €	
191874	5	89,70	1



JUEGO DE LLAVES COMBINADAS CON CARRACA REVERSIBLE, SOPORTE DE PLÁSTICO

COMPOSICIÓN

8, 10, 11, 12, 13, 14, 17, 19 mm.



Cód.	Nº piezas	P.V.P. unid. €	
191876	8	138,47	1



JUEGO DE LLAVES COMBINADAS CON CARRACA REVERSIBLE, SOPORTE DE PLÁSTICO

COMPOSICIÓN

8, 9, 10, 11, 12, 13, 14, 15, 16, 17, 18, 19 mm.

Cód.	Nº piezas	P.V.P. unid. €	
191877	12	199,95	1





LLAVE COMBINADA CON CARRACA REVERSIBLE



- Terminación en cromado satinado mate.
- Carraca reversible de 72 dientes.



ADAPTADORES ACOPLABLES EN PÁG. 133

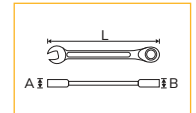

Cód.	Ø mm	L mm	A mm	B mm	P.V.P. unid. €	
170338	8	139,0	5,5	7,5	8,52	5
170339	9	149,0	5,9	7,7	8,63	5
170340	10	158,5	6,1	7,7	8,97	5
170341	11	164,8	6,7	8,7	9,64	5
170342	12	171,0	7,7	9,2	10,26	5
170343	13	177,3	8,6	9,5	10,65	5
170344	14	190,0	8,6	9,7	11,66	5
170345	15	198,8	8,6	10,2	12,39	5
170346	16	207,3	9,1	10,6	13,29	5
170347	17	224,6	9,5	10,7	14,13	5
170348	18	235,5	9,7	11,2	15,19	5
170349	19	247,0	9,7	11,5	15,59	5

Cód.	Ø mm	L mm	A mm	B mm	P.V.P. unid. €	
170350	20	247,0	9,7	11,5	17,74	5
170351	21	290,5	9,7	13,9	17,89	5
170352	22	290,5	9,7	13,9	18,50	5
170353	23	290,5	9,7	13,9	19,11	5
170354	24	332,0	10,5	14,7	21,71	5
170355	25	332,0	10,5	14,7	22,48	5
170356	26	357,0	11,1	15,5	32,67	5
170357	27	357,0	11,1	15,5	32,87	5
170358	28	401,0	12,1	16,7	38,58	5
170360	30	401,0	12,1	16,7	38,69	5
170362	32	423,4	12,5	16,7	49,64	5

04



JUEGO DE LLAVES COMBINADAS CON CARRACA REVERSIBLE, SOP. PLÁSTICO



COMPOSICIÓN

8, 10, 13, 17, 19 mm.



Cód.	Nº piezas	P.V.P. unid. €	
170365	5	54,43	1



JUEGO DE LLAVES COMBINADAS CON CARRACA REVERSIBLE, SOP. PLÁSTICO



COMPOSICIÓN

8, 10, 11, 12, 13, 14, 17, 19 mm.



Cód.	Nº piezas	P.V.P. unid. €	
170367	8	83,23	1



JUEGO DE LLAVES COMBINADAS CON CARRACA REVERSIBLE, SOPORTE DE PLÁSTICO



COMPOSICIÓN

8, 9, 10, 11, 12, 13, 14, 15, 16, 17, 18, 19 mm.

Cód.	Nº piezas	P.V.P. unid. €	
170369	12	127,93	1





LLAVE COMBINADA FLEXIBLE CON CARRACA



- Carraca reversible de 72 dientes.
- Terminación en cromado satinado mate.
- Cabezas pulidas.

04

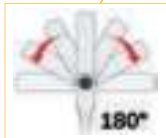

Cabeza flexible. Posibilidad de girar la cabeza a cualquier ángulo en un intervalo de 180°.

VER ADAPTADORES EN PÁG. SIGUIENTE

Cód.	Ø mm	L mm	P.V.P. unid. €		Cód.	Ø mm	L mm	P.V.P. unid. €		Cód.	Ø mm	L mm	P.V.P. unid. €	
191905	8	136	16,67	5	191926	14	193	20,84	5	191937	21	285	32,03	5
191907	9	143	17,27	5	191927	15	200	21,43	5	191939	22	285	32,03	5
191910	10	159	18,39	5	191928	16	216	22,63	5	191941	24	325	38,14	5
191915	11	168	18,88	5	191930	17	233	23,82	5	191943	27	359	54,43	5
191920	12	174	19,65	5	191932	18	239	25,01	5	191945	30	425	66,66	5
191925	13	180	20,24	5	191935	19	248	29,65	5	191947	32	425	66,66	5



JUEGO DE LLAVES COMBINADAS FLEXIBLES CON CARRACA, SOPORTE DE PLÁSTICO

COMPOSICIÓN

8, 10, 13, 17, 19 mm.



Cód.	Nº piezas	P.V.P. unid. €	
191950	5	108,77	1



JUEGO DE LLAVES COMBINADAS FLEXIBLES CON CARRACA, SOPORTE DE PLÁSTICO

COMPOSICIÓN

191951: 8, 10, 11, 12, 13, 14, 17, 19 mm.

191952: 8, 9, 10, 11, 12, 13, 14, 15, 16, 17, 18, 19 mm.



Detalle 191951

Cód.	Nº piezas	P.V.P. unid. €	
191951	8	168,14	1
191952	12	237,21	1



191951



191952



LLAVE ACODADA CON CARRACA REVERSIBLE



- Carraca reversible de 72 dientes.
- Terminación en cromado satinado mate.
- Cabezas pulidas.

Ambas bocas acodadas y reversibles.



Acodado de 15° en la cabeza.

ADAPTADORES ACOPLABLES EN PIE DE PÁGINA



Sistema de carraca que permite trabajar a lo largo de los espárragos y varillas roscadas sin necesidad de retirar la llave.

04

Cód.	mm	L mm	P.V.P. unid. €	
191600	8x9	128	21,28	5
191605	10x11	150	22,79	5
191610	12x13	170	24,21	5

Cód.	mm	L mm	P.V.P. unid. €	
191615	14x15	190	26,60	5
191620	16x18	230	30,44	5
191625	17x19	230	33,08	5



JUEGO DE LLAVES ACODADAS CON CARRACA REVERSIBLE, SOPORTE DE PLÁSTICO

COMPOSICIÓN

8x9, 10x11, 12x13, 14x15, 16x18, 17x19 mm.

Cód.	Nº piezas	P.V.P. unid. €	
191627	6	154,88	1



ADAPTADORES PARA VASOS Y PUNTAS

Cód.	Para	Con llave mm	P.V.P. unid. €	
191880	Vasos 1/4"	10	5,93	5
191881	Vasos 3/8"	13	6,59	5
191882	Vasos 1/2"	19	7,69	5
191885	Puntas 1/4"	10	2,24	5



191880
191881
191882



191885



191882



191881



191880



191885

* Estos adaptadores son válidos para todas las llaves combinadas con carraca y las llaves acodadas con carraca incluidas en las páginas 130, 131, 132 y 133.



LLAVE CON CARRACA REVERSIBLE 4 EN 1



- Carraca reversible 72 dientes.
- Terminación en cromado satinado mate.
- Cabezas pulidas.

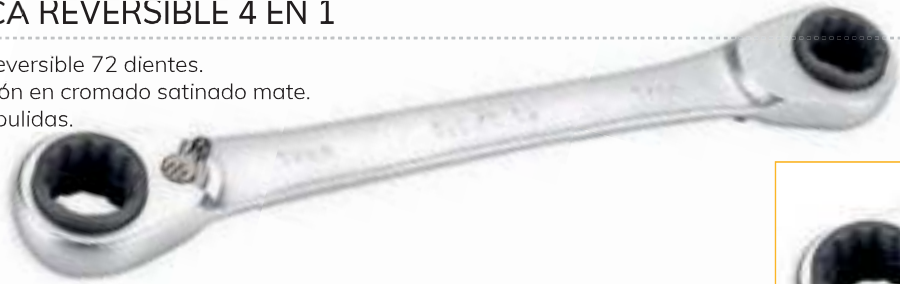

Cada boca se puede utilizar con dos medidas de tuerca diferentes.

04

Cód.	Boca 1 mm	Boca 2 mm	L mm	P.V.P. unid. €	
191630	8x10	12x13	160	22,66	2
191632	9x11	14x15	180	26,52	2
191634	16x17	18x19	225	28,11	2
191636	10x13	17x19	225	28,11	2



JUEGO DE LLAVES CON CARRACA REVERSIBLE 4 EN 1, BOLSA DE NYLON

COMPOSICIÓN

8x10/12x13, 9x11/14x15, 16x17/18x19 mm.

Cód.	Nº piezas	P.V.P. unid. €	
191640	3	76,99	1



LLAVE DE VASO ARTICULADA



- Vaso con boca de 12 caras.
- Terminación cromado.
- Posibilidad de giro del vaso en 180°.



Cód.	mm	L mm	D1 mm	D2 mm	P.V.P. unid. €		Cód.	mm	L mm	D1 mm	D2 mm	P.V.P. unid. €	
191652	6x7	182	9,5	11,0	12,94	2	191664	18x19	275	26,0	26,0	23,65	2
191654	8x9	182	13,0	14,0	12,94	2	191666	20x22	302	28,0	31,0	29,82	2
191656	10x11	198	15,0	16,0	13,31	2	191668	21x23	307	29,0	33,0	31,12	2
191658	12x13	220	18,0	19,0	15,83	2	191670	24x27	333	33,0	36,6	34,46	2
191660	14x15	240	20,0	22,0	17,78	2	191672	30x32	349	39,7	41,7	39,61	2
191662	16x17	260	24,0	24,0	20,36	2							



JUEGO DE LLAVES DE VASO ARTICULADAS, BOLSA DE NYLON

COMPOSICIÓN

6x7, 8x9, 10x11, 12x13, 14x15, 16x17, 18x19, 20x22 mm

Cód.	Nº piezas	P.V.P. unid. €	
191675	8	146,62	1





LLAVE DE UNA BOCA AISLADA

CERTIFICADO VDE

ACERO CR-V EN 60900 D'E GS 1000 V



Mango ergonómico recubierto de material antideslizante.

Ángulo de la cabeza de 15°.

NORMA EN 60900:
Herramientas aisladas utilizadas para trabajos en tensiones de hasta 1000V en Corriente Alterna ó 1500V en Corriente Continua.

04

Cód.	mm	L mm	P.V.P. unid. €	
190157	7	88	15,35	1
190158	8	104	15,35	1
190159	9	104	16,85	1
190160	10	114	16,95	1
190161	11	124	17,67	1
190162	12	124	17,67	1
190163	13	154	19,45	1
190164	14	154	19,45	1

Cód.	mm	L mm	P.V.P. unid. €	
190165	15	170	20,48	1
190166	16	170	22,35	1
190167	17	170	24,15	1
190168	18	180	24,83	1
190169	19	180	26,42	1
190171	21	202	29,44	1
190172	22	202	32,88	1
190174	24	237	36,63	1



JUEGO DE LLAVES DE UNA BOCA AISLADAS, BOLSA DE NYLON

CERTIFICADO VDE

COMPOSICIÓN

8, 10, 13, 17, 19 mm.

Cód.	Nº piezas	P.V.P. unid. €	
190180	5	102,31	1



JUEGO DE LLAVES DE UNA BOCA AISLADAS, BOLSA DE NYLON

CERTIFICADO VDE

COMPOSICIÓN

8, 10, 11, 12, 13, 14, 15, 16, 17, 19 mm.

Cód.	Nº piezas	P.V.P. unid. €	
190182	10	201,57	1





LLAVE ESTRELLA ACODADA AISLADA

CERTIFICADO VDE

ACERO CR-V EN 60900 D'E GS 1000 V



Mango ergonómico recubierto de material antideslizante.

Ángulo de la cabeza de 75 grados.

NORMA EN 60900:
Herramientas aisladas utilizadas para trabajos en tensiones de hasta 1000V en Corriente Alterna ó 1500V en Corriente Continua.

Cód.	Ø mm	L mm	P.V.P. unid. €	📦
190657	7	149	23,15	1
190658	8	164	23,50	1
190659	9	164	23,50	1
190660	10	174	24,38	1
190661	11	184	25,40	1
190662	12	184	25,40	1
190663	13	205	27,70	1
190664	14	205	27,70	1

Cód.	Ø mm	L mm	P.V.P. unid. €	📦
190665	15	216	29,37	1
190666	16	221	30,84	1
190667	17	221	30,84	1
190668	18	237	35,59	1
190669	19	237	35,59	1
190671	21	257	39,11	1
190672	22	257	39,11	1
190674	24	284	46,99	1



JUEGO DE LLAVES ACODADAS AISLADAS, BOLSA DE NYLON

CERTIFICADO VDE

COMPOSICIÓN

8, 10, 13, 17, 19 mm.

Cód.	Nº piezas	P.V.P. unid. €	📦
190675	5	142,00	1



JUEGO DE LLAVES ACODADAS AISLADAS, BOLSA DE NYLON

CERTIFICADO VDE

COMPOSICIÓN

8, 10, 11, 12, 13, 14, 15, 16, 17, 19 mm.

Cód.	Nº piezas	P.V.P. unid. €	📦
190676	10	280,72	1





LLAVE DE CARRACA AISLADA

CERTIFICADO VDE



Mango ergonómico recubierto de material antideslizante.

NORMA EN 60900:
Herramientas aisladas utilizadas para trabajos en tensiones de hasta 1000V en Corriente Alterna ó 1500V en Corriente Continua.

04

Cód.	mm	L mm	P.V.P. unid. €	
190477	7	151	31,08	1
190478	8	167	32,29	1
190479	9	167	32,29	1
190480	10	178	33,02	1
190481	11	189	34,33	1
190482	12	189	34,33	1
190483	13	210	36,46	1
190484	14	210	36,46	1

Cód.	mm	L mm	P.V.P. unid. €	
190486	16	228	41,23	1
190487	17	228	41,23	1
190488	18	243	44,67	1
190489	19	243	44,67	1
190491	21	264	62,40	1
190492	22	264	62,40	1
190494	24	295	70,16	1



JUEGO DE LLAVES DE CARRACA AISLADAS, BOLSA DE NYLON

CERTIFICADO VDE

COMPOSICIÓN

8, 10, 13, 17, 19 mm.

Cód.	Nº piezas	P.V.P. unid. €	
190495	5	187,67	1



LLAVE FIJA DE UNA BOCA

DIN 894



Acabado pavonado.

Cód.	mm	L mm	Grosor mm	P.V.P. unid. €	
190917	17	170	6,0	3,05	1
190919	19	170	6,0	3,92	1
190922	22	193	8,0	4,28	1
190924	24	213	9,0	4,96	1
190927	27	240	9,5	6,01	1
190930	30	253	11,0	6,93	1
190932	32	277	11,5	7,82	1
190934	34	290	12,0	8,75	1
190936	36	309	12,5	11,63	1
190941	41	346	14,0	16,14	1

Cód.	mm	L mm	Grosor mm	P.V.P. unid. €	
190946	46	380	15,5	19,58	1
190950	50	415	15,5	22,86	1
190955	55	456	16,5	39,77	1
190960	60	498	17,5	40,38	1
190965	65	520	18,5	46,50	1
190970	70	560	18,5	57,51	1
190975	75	630	20,5	62,80	1
190980	80	630	21,5	72,82	1
190985	85	680	22,0	88,66	1



LLAVE DE ESTRELLA PLANA DE GOLPE



- Estrella 12 puntas.
- Acabado pavonado.



Modo de empleo.



04

Cód.	mm	L mm	D mm	E mm	P.V.P. unid. €	
191370	24	168	43,4	14,8	17,05	1
191371	27	180	46,0	16,0	18,85	1
191372	30	190	51,5	17,0	22,33	1
191373	32	190	54,0	17,0	24,01	1
191374	36	205	58,5	18,5	27,75	1
191375	38	228	64,6	20,1	34,35	1
191376	41	230	65,0	20,0	37,69	1
191377	46	240	73,5	22,0	41,13	1
191378	50	253	78,5	24,0	48,69	1
191379	55	266	85,0	25,0	60,80	1

Cód.	mm	L mm	D mm	E mm	P.V.P. unid. €	
191381	60	280	92,0	26,0	71,20	1
191382	65	300	102,0	30,0	83,59	1
191383	70	330	110,0	33,0	109,13	1
191384	75	330	110,0	33,0	112,84	1
191385	80	340	118,0	34,0	148,59	1
191386	85	355	130,0	36,0	184,52	1
191387	90	390	142,0	39,0	209,27	1
191388	95	390	142,0	39,0	223,69	1
191389	100	420	155,0	43,0	331,84	1



LLAVE FIJA DE GOLPE

- Acabado pavonado.

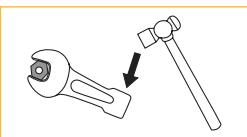

Modo de empleo.

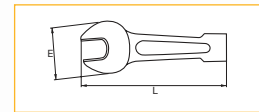

Cód.	mm	L mm	E mm	P.V.P. unid. €	
190824	24	177	52,5	17,10	1
190827	27	180	56,0	18,88	1
190830	30	190	62,0	22,13	1
190832	32	190	62,0	24,05	1
190836	36	215	74,0	28,05	1
190838	38	215	74,0	34,20	1
190841	41	235	86,0	37,20	1
190846	46	255	96,0	41,22	1

Cód.	mm	L mm	E mm	P.V.P. unid. €	
190850	50	275	105,0	48,54	1
190855	55	300	115,0	60,58	1
190860	60	320	126,0	71,15	1
190865	65	343	138,0	82,79	1
190870	70	375	154,0	109,17	1
190875	75	375	154,0	112,72	1
190880	80	400	174,0	146,84	1
190885	85	400	174,0	185,16	1



LLAVE DE TUBO HEXAGONAL FORJADA

ACERO CR-V



Terminación:
• Cabezas pulidas.
• Cromado satinado.



04

Cód.	Ø mm	L mm	D1 mm	D2 mm	P.V.P. unid. €		Cód.	Ø mm	L mm	D1 mm	D2 mm	P.V.P. unid. €	
191405	6x7	105	10,0	11,0	10,54	10	191440	20x22	175	28,0	30,0	24,60	5
191410	8x9	110	12,5	13,5	10,69	10	191445	21x23	185	29,0	31,0	26,23	5
191415	10x11	120	15,0	16,0	11,28	10	191450	24x26	195	32,5	36,5	28,07	5
191420	12x13	140	17,5	19,0	13,23	10	191452	24x27	195	32,5	36,5	28,07	5
191425	14x15	145	20,0	21,5	15,74	10	191455	25x28	205	34,0	37,0	31,48	5
191430	16x17	155	22,5	24,0	18,27	10	191457	27x29	210	36,0	39,0	36,37	5
191435	18x19	165	25,5	26,0	21,68	10	191460	30x32	210	40,0	42,5	41,32	5

Se suministra con colgador.



JUEGO DE LLAVES DE TUBO FORJADAS, SOPORTE DE PLÁSTICO

COMPOSICIÓN

6x7, 8x9, 10x11, 12x13, 14x15, 16x17, 18x19 + volvedor.



Cód.	Nº piezas	P.V.P. unid. €	
191485	8	101,06	1



JUEGO DE LLAVES DE TUBO FORJADAS, CAJA DE PLÁSTICO

COMPOSICIÓN

6x7, 8x9, 10x11, 12x13, 14x15, 16x17, 18x19, 20x22 + volvedor.



Medida caja:
255x185x48mm.

Cód.	Nº piezas	P.V.P. unid. €	
191480	9	127,67	1



JUEGO DE LLAVES DE TUBO FORJADAS, BOLSA DE NYLON

COMPOSICIÓN

6x7, 8x9, 10x11, 12x13, 14x15, 16x17, 18x19, 20x22 mm + volvedor.



Cód.	Nº piezas	P.V.P. unid. €	
191470	9	126,26	1



JUEGO DE LLAVES DE TUBO FORJADAS, BOLSA DE NYLON

COMPOSICIÓN

6x7, 8x9, 10x11, 12x13, 14x15, 16x17, 18x19, 20x22, 21x23, 24x27, 25x28, 30x32 mm + dos volvedores.



Cód.	Nº piezas	P.V.P. unid. €	
191475	14	263,01	1



LLAVE DE TUBO ESTAMPADA



Acabado satinado mate.

Cuerpo redondo y cabeza hexagonal para giro con llave.

Agujero para accionamiento con volvedor.



04

Cód.	mm	L mm	P.V.P. unid. €	
191505	6x7	110	3,44	10
191510	8x9	110	3,60	10
191515	10x11	120	4,15	10
191520	12x13	140	4,94	10
191525	14x15	140	5,32	10
191530	16x17	150	5,73	10
191535	18x19	160	7,24	10
191540	20x22	170	9,22	5

Cód.	mm	L mm	P.V.P. unid. €	
191545	21x23	170	9,62	5
191550	24x26	190	12,97	5
191552	24x27	190	12,97	5
191555	25x28	190	14,05	5
191557	27x29	195	14,20	5
191560	30x32	210	14,46	5
191565	36x41	210	19,41	5

Se suministra con colgador.



JUEGO DE LLAVES DE TUBO ESTAMPADAS, BOLSA DE NYLON

COMPOSICIÓN

6x7, 8x9, 10x11, 12x13, 14x15, 16x17, 18x19, 20x22 mm + volvedor.



Cód.	Nº piezas	P.V.P. unid. €	
191570	9	47,41	1



JUEGO DE LLAVES DE TUBO ESTAMPADAS, BOLSA DE NYLON

COMPOSICIÓN

6x7, 8x9, 10x11, 12x13, 14x15, 16x17, 18x19, 20x22, 21x23, 24x27, 25x28, 30x32 mm + dos volvedores.



Cód.	Nº piezas	P.V.P. unid. €	
191575	14	97,68	1



LLAVE DE CABINA

- 5-6-7-8 mm
- 3-5 mm
- Punta PH2
- 7-9 mm
- Adapt. 1/4"
- Plana 7x1 mm



INCLUYE UN ADAPTADOR DE PLÁSTICO PARA PUNTAS.

Cód.	L mm	P.V.P. unid. €	
191990	60	16,98	6

Se suministra en blíster.



LLAVE DE CABINA

- 5-7-8 mm
- 6-10 mm
- Punta PH2
- 9-10 mm
- Adapt. 1/4"
- Plana 7x1 mm
- 3 mm



INCLUYE UN ADAPTADOR DE PLÁSTICO PARA PUNTAS.

Cód.	L mm	P.V.P. unid. €	
191995	70	17,48	6

Se suministra en blíster.



LLAVE DE PIPA



04

Cód.	Ø mm	L mm	P.V.P. unid. €	
175001	6	105	9,07	5
175002	7	105	9,36	5
175003	8	115	10,34	5
175004	9	122	10,96	5
175005	10	130	11,59	5
175006	11	136	11,68	5
175007	12	145	12,48	5
175008	13	152	13,41	5
175009	14	160	14,28	5
175010	15	170	15,68	5
175011	16	178	17,12	5
175012	17	187	18,03	5
175013	18	195	19,19	5
175014	19	205	19,72	5

Cód.	Ø mm	L mm	P.V.P. unid. €	
175015	20	212	21,51	5
175016	21	225	24,01	5
175017	22	225	25,69	5
175018	23	240	27,72	5
175019	24	250	28,12	1
175020	25	270	29,04	1
175021	26	270	36,96	1
175022	27	280	37,84	1
175023	28	290	39,39	1
175024	29	300	43,15	1
175025	30	310	49,12	1
175026	32	330	50,75	1
175027	36	355	68,48	1



JUEGO DE LLAVES PIPA, SOPORTE DE PLÁSTICO

COMPOSICIÓN

10, 11, 12, 13, 17, 19 mm.

Cód.	Nº piezas	P.V.P. unid. €	
175030	6	86,00	1



DESMONTADOR

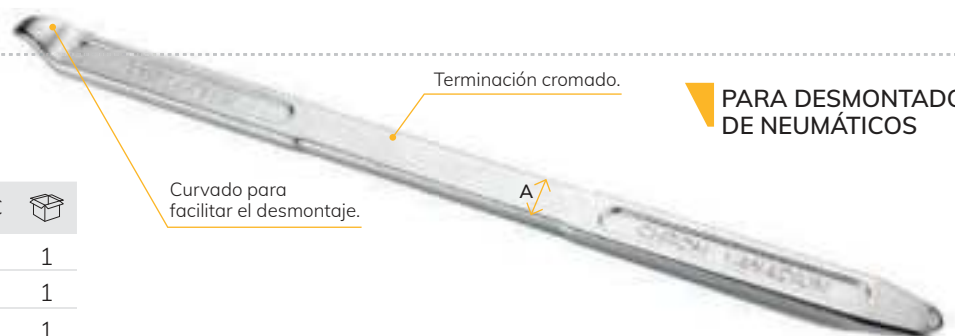

Cód.	L mm	A mm	P.V.P. unid. €	
118050	215	16	5,36	1
118052	350	24	10,79	1
118054	500	28	19,65	1



LLAVE PARA RUEDAS



- Mango moleteado.
- Terminación satinado mate.

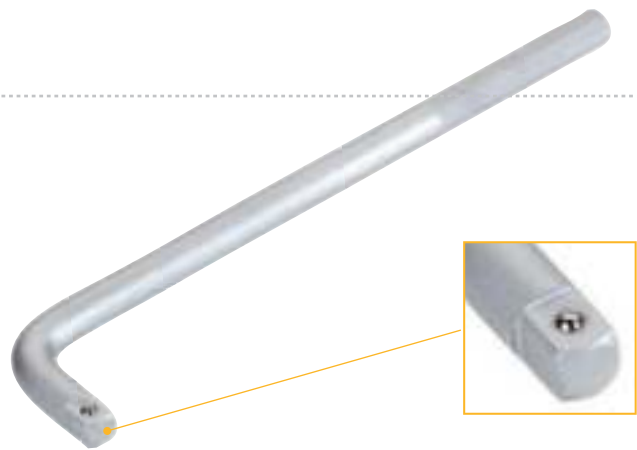

Cód.	■"	L mm	L"	Ø mm	P.V.P. unid. €	
191492	1/2	300	12	14	13,10	1
191494	3/4	300	12	20	23,29	1
191496	3/4	450	18	20	34,30	1

04



LLAVE EN CRUZ



- Templado a 45÷ 50 HRC.
- Terminación satinado mate y bocas pulidas.
- Soldadura reforzada. Preparada para trabajos pesados.

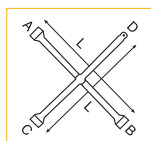

Cód.	L mm	L"	⊕ mm	⊕ mm	⊕ mm	■"	P.V.P. unid. €	
191498	375	15	17	19	22	1/2	29,71	1
191499	625	25	24	27	32	3/4	87,97	1



LLAVE MAGNÉTICA PARA BUJÍAS CON MANGO EN T



- Articulación universal para trabajar a diferentes ángulos.
- Presentación cromado.
- Vaso magnético y hexagonal.



Cód.	⊕ mm	L mm	S mm	D mm	P.V.P. unid. €	
191695	16	300	200	22	25,73	1
191697	21	300	200	28	26,72	1

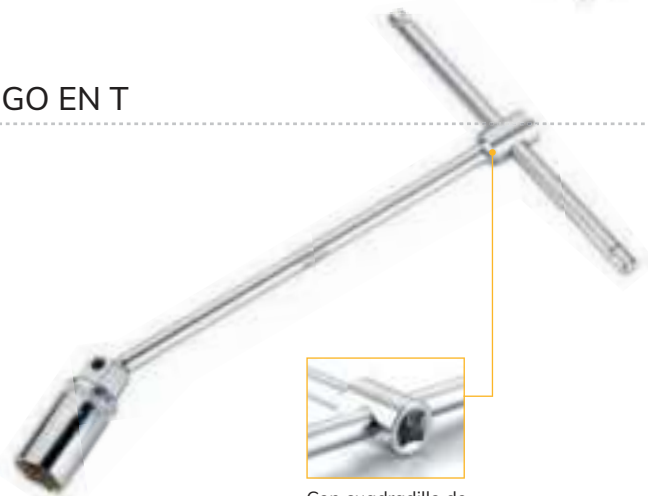

Con cuadradillo de 3/8" para accionar con llave de carraca.



LLAVE DE VASO CON MANGO EN T



- Presentación cromado.



Cód.	⊕ mm	L mm	S mm	D mm	P.V.P. unid. €	
191682	8	390	200	12,5	23,65	1
191684	10	500	200	15,0	25,07	1
191686	12	500	200	17,5	25,07	1
191688	13	500	200	18,0	25,07	1
191690	17	500	200	24,0	26,27	1
191692	19	500	200	26,0	27,95	1



Articulación universal.

Con cuadradillo de 3/8" para accionar con llave de carraca.



LLAVE AJUSTABLE DE MOLETA LATERAL

DIN 3117

ACERO CR-V



Comparativa NORMAS DIN		
Cód.	C (DIN) mm	C mm
172270	19	23,9
172271	24	28,6
172272	28	32,8
172273	34	38,1
172274	43	50,0
172275	52	62,0

Cód.	L mm	L "	C mm	D mm	P.V.P. unid. €		Cód.	L mm	L "	C mm	D mm	P.V.P. unid. €	
172270	150	6	23,9	23,0	26,22	6	172273	300	12	38,1	39,0	45,90	6
172271	200	8	28,6	26,5	29,04	6	172274	400	16	50,0	48,0	74,40	1
172272	250	10	32,8	31,0	35,89	6	172275	500	20	62,0	65,0	126,80	1

Se suministra en colgador.



LLAVE AJUSTABLE DE MOLETA CENTRAL

DIN 3117

ACERO CR-V



Cód.	L mm	L "	C mm	D mm	P.V.P. unid. €		Cód.	L mm	L "	C mm	D mm	P.V.P. unid. €	
172250	150	6	20	18	15,51	6	172254	380	15	43	44	52,38	2
172251	200	8	24	25	17,97	6	172255	450	18	53	53	79,12	2
172252	250	10	29	29	22,49	6	172256	600	24	70	62	152,95	1
172253	300	12	34	32	29,00	6							

Se suministra en colgador.



LLAVE AJUSTABLE DE MOLETA CENTRAL

DIN 3117

ACERO CR-V



Cód.	L mm	L "	C mm	D mm	P.V.P. unid. €		Cód.	L mm	L "	C mm	D mm	P.V.P. unid. €	
170650	150	6	19	20	10,49	6	170665	300	12	34	36	17,91	6
170655	200	8	24	25	11,72	6	170670	375	15	46	43	32,00	2
170660	250	10	28	30	16,07	6	170675	450	18	54	53	67,18	2

Se suministra en colgador.

04



LLAVE AJUSTABLE DE APERTURA EXTRA

DIN 3117 **ACERO CR-V**

Comparativa apertura y profundidad de bocas

Cód.	C	C (DIN)	D	D (DIN)
172280	34	19	28,9	17,5
172281	38	24	32,4	22,0
172282	50	28	41,0	26,0
172283	60	34	55,7	29,0

Comparación con los valores marcados por la norma DIN.

Cód.	L mm	L "	P.V.P. unid. €	
172280	150	6	22,95	6
172281	200	8	26,87	6
172282	250	10	33,01	5
172283	300	12	43,77	5

Se suministra con colgador.

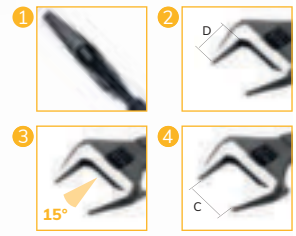

- 1 Perfil estrecho de las bocas para lugares de difícil acceso. Pares de torsión muy superiores a la norma DIN.
- 2 Bocas muy profundas, altura de boca aproximadamente un 30% mayor que la norma DIN.
- 3 Ángulo de 15° que permite una alineación entre la llave y la tuerca para aprietes rápidos, precisos y ergonómicos.
- 4 Llave ajustable de bocas de gran apertura. Aproximadamente un 55% mayor que la norma DIN.



LLAVE AJUSTABLE DE BOCA REVERSIBLE

DIN 3117 **ACERO CR-V**



Boca reversible para uso con tubos y tuercas.

Cód.	L mm	L "	P.V.P. unid. €	
172265	200	8	30,35	6

Se suministra en blíster.

Cód.	L mm	C mm	C (DIN) mm	D mm
172265	200	38	24	32



Apertura de la boca que excede un 50% las normas DIN.



LLAVE AJUSTABLE CORTA DE GRAN APERTURA

DIN 3117 **ACERO CR-V**



30% MÁS LIGERA

- Evita el redondeo de tuercas.
- Gran apertura, 50% mayor que la norma DIN.
- Gran profundidad de bocas.



Cód.	L mm	L "	C mm	D mm	P.V.P. unid. €	
172286	140	5,5	32	30	23,01	6
172288	160	6,3	43	41	29,86	6

Se suministra en blister.



LLAVE AJUSTABLE CON CARRACA

DIN 3117 **ACERO CR-V**

- DOBLE FUNCIÓN:**
- Estándar: Botón a izquierda.
 - Carraca: Botón a derecha.



Función carraca

Cód.	L mm	L "	C mm	D mm	P.V.P. unid. €	
172277	200	8	29	26	28,46	3

Se suministra con colgador.



LLAVE AJUSTABLE AISLADA

CERTIFICADO VDE



- Mango recubierto de material aislante.
- Cabeza graduada para preajustes.
- Marcado indeleble del certificado.

NORMA EN 60900:
Herramientas aisladas para trabajos en tensiones de hasta 1000V en Corriente Alterna ó 1500V en Corriente Continua.

Cód.	L mm	L "	P.V.P. unid. €	
172295	200	8	46,56	2
172296	250	10	57,51	2



04



LLAVE ARTICULADA DE PIVOTE FIJO



- Llave forjada.
- Terminación cromado satinado.

CADA LLAVE ES ADECUADA PARA
DIVERSOS DIÁMETROS DE TUERCA

Cód.	Nº	Ø mm	L mm	P.V.P. unid. €	
145101	0	15-35	168	25,10	6
145102	1	35-50	202	27,33	6
145103	2	50-80	280	37,50	6
145104	3	80-120	345	48,60	4
145105	4	120-180	492	66,84	2



LLAVE ARTICULADA DE PIVOTE CON TORNILLO



- Llave forjada.
- Terminación cromado satinado.

CADA LLAVE ES ADECUADA PARA
DIVERSOS DIÁMETROS DE TUERCA

Cód.	Nº	Ø mm	L mm	D mm	P.V.P. unid. €	
145106	0	15-35	168	3	26,81	6
145107	1	35-50	202	4	29,63	6
145108	2	50-80	280	5	38,58	6
145109	3	80-120	345	6	51,79	4
145110	4	120-180	492	8	69,30	2



TORNILLO DE REPUESTO PARA LLAVES ARTICULADAS

Cód.	Nº	D mm	P.V.P. unid. €	
164021	0	3	3,22	6
164022	1	4	3,69	6
164023	2	5	4,57	6

Cód.	Nº	D mm	P.V.P. unid. €	
164024	3	6	5,05	6
164025	4	8	6,20	6



LLAVES DINAMOMÉTRICAS

Cuidados y servicios

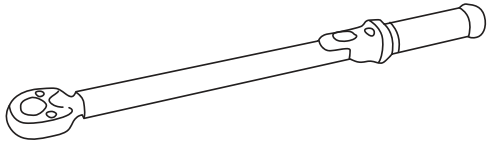

Una llave dinamométrica es una herramienta que se utiliza para aplicar una cantidad específica de torque o fuerza de torsión a un objeto. Su función principal es asegurar que las tuercas y pernos estén apretados con la cantidad exacta de fuerza necesaria para que las piezas no se aflojen con el tiempo.

1 Es un instrumento de precisión.

La llave dinamométrica es muy sensible por lo que no debe emplearse para aflojar pernos. Una vez terminado el trabajo hay que restablecer su valor más bajo para que no esté bajo presión y guardarla adecuadamente para evitar golpes.

2 La llave dinamométrica debe utilizarse con una mano y un movimiento continuado y fluido.

3 No debe usarse una extensión en el mango.

Esto perjudicaría el valor establecido al estar correctamente señalado.

4 Una llave dinamométrica previene pero no evita el ajuste excesivo.

Cuando se alcanza el par requerido, el usuario escuchará un sonido de "clic". Si oye ese "clic" sin mover la llave al principio, significa que la aplicación del par se ha ajustado demasiado. La buena práctica es comenzar de nuevo: afloje primero el perno, apriétele con una herramienta adaptada y termine con la llave dinamométrica para alcanzar el par correcto y seguro.

5 Mantenimiento de la llave dinamométrica

Al ser una herramienta de alta precisión, debe ser recalibrada con cierta frecuencia. Esta recalibración es responsabilidad del usuario de la herramienta. La recalibración debe realizarse **anualmente** en el servicio oficial del fabricante.



Para que tengas tu llave siempre al día, te ofrecemos los siguientes servicios

Servicio de calibración

Certificado emitido por ALYCO TOOLS, S.A.



Cada llave lleva grabado un nº de identificación que coincide con el certificado que expide el fabricante y que se suministra en el estuche junto con la llave. **La validez de dicho certificado es de 1 AÑO desde la fecha del albarán que emite ALYCO y en el que se refleja, igualmente, el nº de identificación de la dinamométrica.** Expirada la vigencia del certificado, se podrá solicitar la expedición de uno nuevo por idéntico periodo de validez, emitido por ALYCO. La emisión de este certificado de calibración, con validez de 1 año, independientemente del modelo o capacidad de la llave, será de **36,00 € + IVA.**

Certificado emitido por una entidad ENAC.



En caso de necesitar un certificado oficial ENAC, el coste de la certificación, en función de la capacidad de la llave, es el que se indica a continuación:

- Hasta 300Nm - **100,00 € + IVA.**
- De 301Nm a 700Nm - **120,00 € + IVA.**
- A partir de 700Nm - **140,00 € + IVA.**

La validez de este certificado es, igualmente, de 1 año desde la fecha del albarán de envío del certificado por ALYCO.

MUY IMPORTANTE: toda llave que no tenga un certificado de calibración en vigor quedará fuera de garantía. La garantía de calibración cubre cualquier defecto de fabricación que implique un mal funcionamiento de la herramienta. ALYCO no se responsabilizará, en caso de mal uso o de deterioro exterior de la herramienta, o en caso de pérdida del nº de identificación de la llave, de la garantía de la misma.

Servicio de reparación



En caso de que la llave requiera de alguna reparación, ALYCO analizará si la reparación es viable y, en caso de serlo, el coste de esta será de **50,00 € + IVA.**

Este coste es independiente del coste de recalibración. Para poder acceder a este servicio de reparación es necesario que la llave tenga un certificado de calibración en vigor. De lo contrario, ALYCO no realizará ningún servicio de reparación sobre dicha llave.

Los portes correrán siempre a cargo del cliente y se cargarán en factura **20,00 € + IVA** en concepto de recogida y entrega de la llave.





LLAVE DINAMOMÉTRICA CON VISOR

DIN 6789

PRECISIÓN DEL PAR $\pm 3\%$
PARA APRIETES A DERECHAS



Certificado de calibración y número de serie individual.



Presentación en estuche individual.



INSTRUCCIONES DE USO

04

Cód.	■"	Capacidad Nm	P.V.P. unid. €		Cód.	■"	Capacidad Nm	Capacidad Kgm	Capacidad Lb-ft	L mm	Precisión Nm	Carraca dientes
192920	1/4	2-25	165,21	1	192920	1/4	2-25	0,2-2,5	1,5-18	300	0,10	24
192930	3/8	5-50	185,94	1	192930	3/8	5-50	0,5-5,0	3,5-37	330	0,25	24
192898	1/2	10-100	192,70	1	192898	1/2	10-100	1,0-10,0	8,0-75	400	0,50	32
192900	1/2	20-200	205,53	1	192900	1/2	20-200	2,0-20,0	10-150	500	1,00	32
192910	1/2	60-300	265,70	1	192910	1/2	60-300	6,0-30,0	45-220	635	1,00	32
192940*	3/4	80-400	440,59	1	192940	3/4	80-400	8,0-40,0	66-290	610	2,00	24
192945*	3/4	150-800	770,63	1	192945	3/4	150-800	15,0-80,0	129-572	1250	2,00	24

*Las llaves dinamométricas cód. 192940 y 192945 no disponen de visor. Recambios de mecanismo disponibles en la página siguiente.



LLAVE DINAMOMÉTRICA 1"

DIN 6789

15°
24 Dientes

- Número de serie y certificado de calibración individual.
- Escala impresa de N.m/Lb.Ft.
- Diseño especial para ajuste rápido y sin esfuerzo del par.

PRECISIÓN DEL PAR $\pm 3\%$

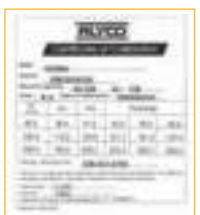

Certificado de calibración y número de serie individual.

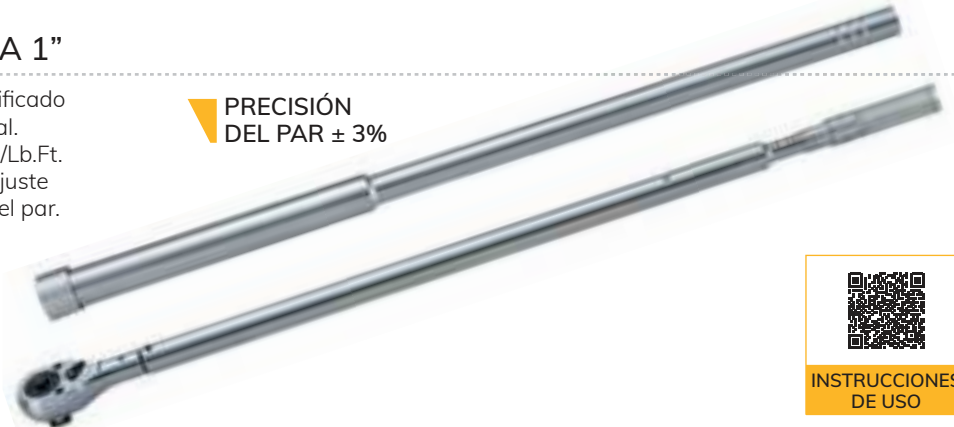

INSTRUCCIONES DE USO

Cód.	■"	Capacidad Nm	P.V.P. unid. €		Cód.	■"	Capacidad Nm	Capacidad Kgm	Capacidad Lb-ft	L mm	Precisión Nm
192948	1	300-1500	1.701,45	1	192948	1	300-1500	30-150	258-1070	1850	10,0

Presentación en estuche individual.



MINI LLAVE DINAMOMÉTRICA

DIN 6789

5,6°
64
Dientes

PRECISIÓN DEL PAR ± 3%



Certificado de calibración y número de serie individual.



Escala impresa N.m y Lb.Ft



04

Cód.	"	Carraca dientes	Cap. Nm	Cap. Kgm	L mm	Precisión Nm	P.V.P. unid. €	
192895	1/4	64	1-6	0.1-0.6	210	0,05	147,88	1



LLAVE DINAMOMÉTRICA DE DISPARO SLIPPER

DIN 6789

PRECISIÓN DEL PAR ± 6% EN 194200/194205
PRECISIÓN DEL PAR ± 4% EN 194215/194220



Certificado de calibración y número de serie individual.



INSTRUCCIONES DE USO

Cód.	"	Capacidad Nm	P.V.P. unid. €	
194200	1/4	1-5	200,10	1
194205	1/4	2-10	211,42	1
194215	1/4	5-25	217,71	1
194220	3/8	10-60	261,76	1

Cód.	"	Cap. Nm	Cap. Kgm	Cap. Lb-ft	L mm	Precisión Nm	Carraca dientes
194200	1/4	1-5	0,1-0,5	0,7-3,7	260	0,05	36
194205	1/4	2-10	0,2-1,0	1,5-7,4	260	0,10	36
194215	1/4	5-25	0,5-2,5	3,5-18,0	320	0,10	36
194220	3/8	10-60	1,0-6,0	8,0-44,0	355	0,25	48



KIT DE REPARACIÓN DE LLAVES DINAMOMÉTRICAS CON VISOR



Cód.	"	Para llave	P.V.P. unid. €	
199168	1/4	192920	11,33	1
199170	3/8	192930	12,58	1
199172	1/2	192898	15,73	1
199174	1/2	192900/192910	22,02	1
199176	3/4	192940	29,57	1
199178	3/4	192945	50,34	1



KIT DE REPARACIÓN DE LLAVES DINAMOMÉTRICAS DISPARO SLIPPER



Cód.	"	Para llave	P.V.P. unid. €	
199166	1/4	194200/194205	75,51	1
199167	1/4	194215	88,09	1
199171	3/8	194220	94,38	1



MANGO DINAMOMÉTRICO PARA CABEZAS INTERCAMBIABLES

- Para cabezas intercambiables de 9x12 y 14x18 mm.
- Botón para soltado fácil de la cabeza.
- Mango ergonómico y confortable.
- Ajuste rápido y preciso del par en el mango.

PRECISIÓN DEL PAR ± 3%
APRIETES A DERECHA E IZQUIERDA



Certificado de calibración y número de serie individual.



Escala impresa N.m y Lb.Ft

04

Cód.	∅mm	Capacidad Nm	Capacidad Kg	Precisión Nm	P.V.P. unid. €	
194100	9x12	4-20	0.4-2	0,1	160,14	1
194105	9x12	20-100	2-10	0,5	199,76	1
194110	14x18	40-200	4-20	1,0	204,53	1
194115	14x18	50-350	5-35	2,0	214,66	1



Presentación en estuche individual.



INSTRUCCIONES DE USO



CABEZA INTERCAMBIABLE DE CARRACA



Cód.	∅mm	L mm		P.V.P. unid. €	
194180	9x12	46	1/4"	37,68	1
194182	9x12	60	1/2"	48,45	1
194184	14x18	70	1/2"	49,87	1



CABEZA INTERCAMBIABLE, BOCA ABIERTA



Cód.	∅mm	∅ mm	LxWxT mm	P.V.P. unid. €	
194120	9x12	10	40x25x6,0	21,21	1
194121	9x12	11	40x25x6,0	21,21	1
194122	9x12	12	40x27x6,0	21,21	1
194123	9x12	13	40x29x6,0	21,21	1
194124	9x12	14	44x32x8,0	21,21	1
194127	9x12	17	44x38x8,0	22,88	1
194129	9x12	19	45x42x8,0	22,88	1
194133	14x18	13	58x30x7,0	26,47	1
194137	14x18	17	60x38x9,0	26,47	1
194139	14x18	19	60x41x9,0	26,47	1
194142	14x18	22	62x48x11,0	29,64	1
194144	14x18	24	64x51x11,0	29,64	1
194145	14x18	27	70x60x13,5	38,66	1
194146	14x18	30	71x64x13,5	38,66	1
194147	14x18	32	73x66x13,5	38,66	1
194148	14x18	36	75x68x13,5	38,66	1
194149	14x18	41	80x83x13,5	38,66	1



CABEZA INTERCAMBIABLE, BOCA ESTRELLA

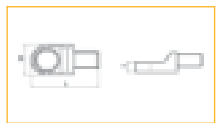

Cód.	∅mm	∅ mm	LxWxT mm	P.V.P. unid. €	
194150	9x12	10	42x20x8,0	20,49	1
194151	9x12	11	44x21x8,0	20,49	1
194152	9x12	12	44x22x12,2	20,49	1
194153	9x12	13	44x22x12,2	20,49	1
194154	9x12	14	44x22x12,2	20,49	1
194157	9x12	17	48x28x13,2	21,46	1
194159	9x12	19	50x32x13,2	21,46	1
194163	14x18	13	60x30x12,0	25,63	1
194167	14x18	17	64x31x12,5	25,63	1
194169	14x18	19	66x31x12,5	25,63	1
194172	14x18	22	69x36x15,0	27,28	1
194174	14x18	24	69x38x15,0	27,28	1
194175	14x18	27	78x42x17,5	36,12	1
194176	14x18	30	78x45x17,5	36,12	1
194177	14x18	32	80x48x17,5	36,12	1
194178	14x18	36	83x54x19,0	36,12	1
194179	14x18	41	85x60x19,0	36,12	1



JUEGO MANGO DINAMOMÉTRICO Y CABEZAS



PRECISIÓN DEL PAR ± 3%
BOCAS 14X18 MM

COMPOSICIÓN

1 Mango dinamométrico 50-350 Nm 194115.
1 Cabeza intercambiable de carraca 194184.
9 Cabezas intercambiables abiertas 13,14,15, 17,19,22,24,27,30 mm.



Medida caja: 620x150x65 mm.

04

Cód.	Nº piezas	P.V.P. unid. €	
192891	11	490,80	1



DESTORNILLADOR DINAMOMÉTRICO



- Ajuste automático del par mediante tornillo.
- Escala marcada en láser.
- Mango ergonómico de goma antideslizante.
- Certificado de calibración individual.

PRECISIÓN DEL PAR ± 5%



INSTRUCCIONES DE USO

Cód.	Ø "	Cap. cNm	Cap. Nm	Precisión cNm/Nm	P.V.P. unid. €	
192885	1/4	10-120	0,1-1,20	1/0,01	199,38	1

Se suministra en estuche de plástico.



DESTORNILLADOR DINAMOMÉTRICO GRAN PAR



- Ajuste automático del par mediante tornillo.
- Escala marcada en láser.
- Mango ergonómico de goma antideslizante.
- Certificado de calibración individual.

PRECISIÓN DEL PAR ± 5%



INSTRUCCIONES DE USO

Cód.	Ø "	Cap. cNm	Cap. Nm	Precisión cNm/Nm	P.V.P. unid. €	
192890	1/4	100-600	1,0-6,0	10/0,1	210,26	1

Se suministra en estuche de plástico.



GONIÓMETRO

- Escala de 360° dividida en marcas de 2°.
- Escala con protector plástico para prevenir la suciedad.
- Tornillo ajustable que mantiene la escala angular fija.



Cód.	Hembra <input checked="" type="checkbox"/>	Macho <input type="checkbox"/>	P.V.P. unid. €	
192897	1/2"	1/2"	35,51	1

Se suministra en blíster.



MULTIPLICADOR DE PARES

FACTOR MULTIPLICADOR 5:1
SE INCLUYE BARRA Y PIE DE REACCIÓN



INSTRUCCIONES DE USO

Cód.	Par máx. entrada Nm	Par máx. salida Nm	Entrada	Salida	P.V.P. unid. €	
192892	300	1500	1/2"	3/4"	851,98	1
192893	540	2700	3/4"	1"	888,52	1

05

LLAVES MACHO

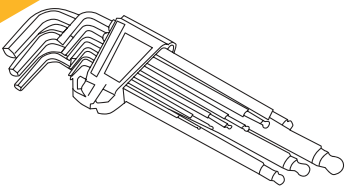

Llave macho con recubrimiento **152**

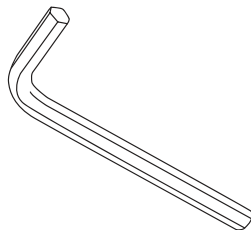

Llave macho Allen **153**

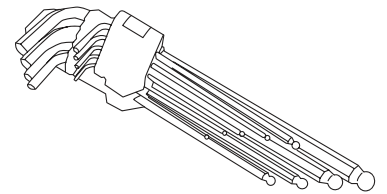

Llave macho de bola **156**

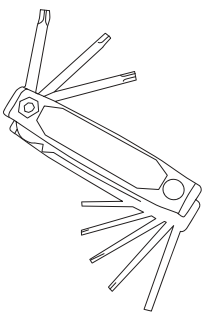

Llave macho Torx **158**

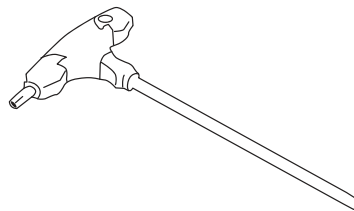

Mango en T **160**

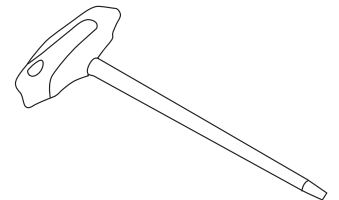

Mango en T aislado **161**

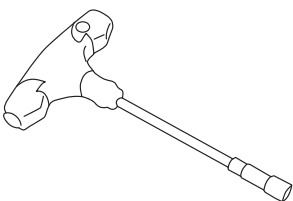

Mango en T con vaso **161**

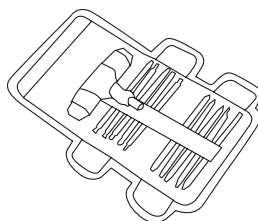

Juego de mangos en T **162**



JUEGO DE LLAVES ALLEN BOLA-DIAMANTE, SOPORTE DE GOMA

ACERO CR-V S2



SERIE EXTRALARGA

COMPOSICIÓN

1.5, 2, 2.5, 3, 4, 5, 6, 8, 10 mm.

Recubrimiento plástico rugoso antideslizante.



Soporte de goma de una sola pieza

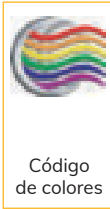

Código de colores



PERFIL DE DIAMANTE



Mayor superficie de contacto con la pieza gracias al perfil especial en forma de diamante.

Extremos imantados.

Cód.	Nº piezas	P.V.P. unid. €	
193145	9	25,45	6

Se suministra en blíster.



LLAVE ALLEN BOLA-DIAMANTE CON RECUBRIMIENTO

ACERO CR-V S2



SERIE EXTRALARGA

Cód.	mm	L mm	P.V.P. unid. €	
193171	1,5	92	1,27	10
193172	2	100	1,55	10
193182	2,5	115	1,66	10
193173	3	130	1,71	10
193174	4	145	2,05	10
193175	5	165	2,44	10
193176	6	186	3,75	10
193178	8	208	5,33	10
193181	10	234	8,01	10

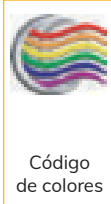

Código de colores



Se suministra en blíster.



JUEGO DE LLAVES ALLEN, SOPORTE DE GOMA

ACERO CR-V S2



SERIE EXTRALARGA

■ Mismas características que 193145.

COMPOSICIÓN

1.5, 2, 2.5, 3, 4, 5, 6, 8, 10 mm



Código de colores



Cód.	Nº piezas	P.V.P. unid. €	
193144	9	20,76	6

Se suministra en blíster.



JUEGO DE LLAVES TORX INVOLABLES, SOPORTE DE GOMA



■ Mismas características que 193145.

SERIE EXTRALARGA

COMPOSICIÓN

T10, T15, T20, T25, T27, T30, T40, T45, T50.

Cód.	Nº piezas	P.V.P. unid. €	
193148	9	37,53	6



Se suministra en blíster.



05



LLAVE ALLEN ACODADA



■ Terminación niquelado.

SERIE NORMAL



Cód.	mm	L mm	E mm	P.V.P. unid. €	
193015	1,5	47	12	0,54	10
193002	2	50	16	0,56	10
193025	2,5	56	18	0,62	10
193003	3	63	20	0,71	10
193004	4	70	25	0,81	10
193005	5	80	28	0,98	10
193006	6	90	32	1,14	10
193007	7	95	34	1,54	10
193008	8	100	36	1,79	10
193009	9	105	38	2,35	10
193010	10	112	40	2,41	10
193012	12	125	45	3,62	5
193014	14	140	56	5,06	5
193017	17	160	63	8,19	5
193019	19	180	70	12,29	5
193022	22	200	80	16,90	5

Cód.	"	L mm	E mm	P.V.P. unid. €	
190450	1/16	47	12	0,54	10
190451	5/64	50	16	0,56	10
190452	3/32	56	18	0,62	10
190453	1/8	63	20	0,71	10
190454	5/32	70	25	0,81	10
190455	3/16	80	28	0,98	10
190456	1/4	90	32	1,14	10
190457	5/16	100	36	1,54	10
190458	3/8	115	40	1,79	10



LLAVE ALLEN ACODADA



SERIE NORMAL



Cód.	mm	P.V.P. unid. €	
170682	2	0,27	20
170681	2,5	0,30	20
170683	3	0,35	20
170684	4	0,42	20
170685	5	0,50	10

Cód.	mm	P.V.P. unid. €	
170686	6	0,58	10
170687	7	0,79	10
170688	8	0,91	5
170690	10	1,38	5
170692	12	2,50	5



Se suministra en bolsa de plástico.

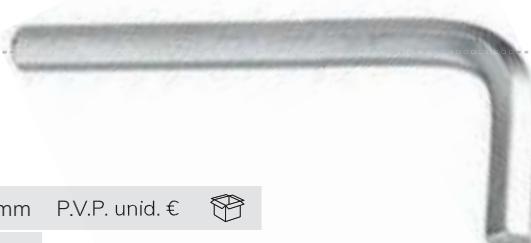



JUEGO DE LLAVES ALLEN, SOPORTE DE PLÁSTICO

ACERO CR-V



SERIE NORMAL

- Terminación niquelado.
- Soporte de plástico con bisagra de apertura.

COMPOSICIÓN

193070: 1.5, 2, 2.5, 3, 4, 5, 6, 8, 10 mm.
193071: 1/16", 5/64", 3/32", 1/8", 5/32", 3/16", 1/4", 5/16", 3/8".

Cód.	Nº piezas	P.V.P. unid. €	
193070	9	9,74	6
193071	9	9,74	1



05

Se suministra en blíster.



JUEGO DE LLAVES ALLEN SOPORTE DE PLÁSTICO

ACERO CR-V



SERIE NORMAL

COMPOSICIÓN

1.5, 2, 2.5, 3, 4, 5, 6 mm.



Cód.	Nº piezas	P.V.P. unid. €	
170607	7	3,50	12

Se suministra en blíster.



JUEGO DE LLAVES ALLEN SOPORTE DE PLÁSTICO

ACERO CR-V



SERIE LARGA

COMPOSICIÓN

1.5, 2, 2.5, 3, 4, 5, 6, 8, 10 mm.



Cód.	Nº piezas	P.V.P. unid. €	
170609	9	9,13	6

Se suministra en blíster.



JUEGO DE LLAVES ALLEN EN NAVAJA

ACERO CR-V



- Sistema de expulsión de llaves mediante palanca.

COMPOSICIÓN

1.5, 2, 2.5, 3, 4, 5, 6, 8 mm.



Cód.	Nº piezas	P.V.P. unid. €	
193082	8	11,31	6

Se suministra con colgador.



JUEGO DE LLAVES ALLEN EN NAVAJA

ACERO CR-V



- Incluye mosquetón para poder colgarlo.

COMPOSICIÓN

1.5, 2, 2.5, 3, 4, 5, 6, 8 mm.



Soporte Aluminio Anodizado

Cód.	Nº piezas	P.V.P. unid. €	
170605	8	7,73	6

Se suministra con colgador.



LLAVE ALLEN ACODADA

DIN 2936

ACERO CR-V



SERIE EXTRALARGA

■ Terminación niquelado.

Cód.	mm	L mm	E mm	P.V.P. unid. €	
193902	2	100	14	0,74	10
193925	2,5	112	18	0,81	10
193903	3	126	20	1,02	10
193904	4	142	25	1,14	10
193905	5	160	28	1,67	10
193906	6	180	32	2,02	10
193907	7	190	34	2,49	10
193908	8	200	36	2,98	10
193910	10	224	40	4,53	10
193912	12	250	45	6,55	5
193914	14	280	55	9,53	5

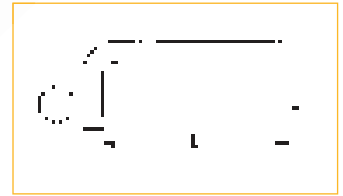

05



JUEGO DE LLAVES ALLEN, SOPORTE DE PLÁSTICO

ACERO CR-V



SERIE EXTRALARGA

COMPOSICIÓN

1,5, 2, 2,5, 3, 4, 5, 6, 8, 10 mm.

Cód.	Nº piezas	P.V.P. unid. €	
193970	9	13,80	6

Se suministra en blíster.



JUEGO COMBINADO DE LLAVES ALLEN Y TORX



ACERO CR-V



SERIE NORMAL

COMPOSICIÓN

1,5, 2, 2,5, 3, 4, 5, 6, 8, 10 mm.

T10, T15, T20, T25, T27, T30, T40, T45, T50.

Cód.	Nº piezas	P.V.P. unid. €	
170622	18	16,80	6

Se suministra en blíster.





LLAVE ALLEN DE BOLA ACODADA



■ Terminación niquelado.



SERIE EXTRALARGA

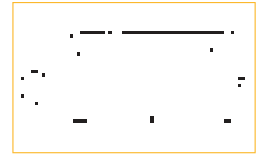

Cód.	mm	L mm	E mm	P.V.P. unid. €	
193102	2	100	14	1,37	10
193125	2,5	112	18	1,44	10
193103	3	126	20	1,50	10
193104	4	142	25	1,79	10
193105	5	160	28	2,12	10
193106	6	180	32	3,26	10
193107	7	190	34	3,57	10
193108	8	200	36	4,64	10
193110	10	224	40	7,91	10
193112	12	250	45	8,50	5
193114	14	280	55	13,71	5

Cód.	"	L mm	E mm	P.V.P. unid. €	
190460	1/16	85	12	1,31	10
190461	5/64	100	14	1,37	10
190462	3/32	112	18	1,44	10
190463	1/8	126	20	1,50	10
190464	5/32	142	25	1,79	10
190465	3/16	160	28	2,12	10
190466	1/4	180	32	3,26	10
190467	5/16	200	36	4,53	10
190468	3/8	224	40	7,91	10

05



JUEGO DE LLAVES ALLEN DE BOLA, SOPORTE DE PLÁSTICO



COMPOSICIÓN

1,5, 2, 2,5, 3, 4, 5, 6, 8, 10 mm.

SERIE NORMAL

Cód.	Nº piezas	P.V.P. unid. €	
193140	9	10,80	6

Se suministra en blíster.



JUEGO DE LLAVES ALLEN DE BOLA, SOPORTE DE PLÁSTICO



COMPOSICIÓN

1,5, 2, 2,5, 3, 4, 5, 6, 8, 10 mm.

SERIE EXTRALARGA

Cód.	Nº piezas	P.V.P. unid. €	
193130	9	15,48	6

Se suministra en blíster.





JUEGO DE LLAVES ALLEN DE BOLA, SOPORTE DE PLÁSTICO



SERIE EXTRALARGA

COMPOSICIÓN

1/16", 5/64", 3/32", 1/8", 5/32", 3/16", 1/4", 5/16", 3/8".



Cód.	Nº piezas	P.V.P. unid. €	
193131	9	15,84	1

Se suministra en blíster.



05



JUEGO DE LLAVES ALLEN DE BOLA, SOPORTE DE PLÁSTICO



SERIE LARGA

COMPOSICIÓN

1.5, 2, 2.5, 3, 4, 5, 6, 8, 10 mm.

Cód.	Nº piezas	P.V.P. unid. €	
170610	9	10,09	6

Se suministra en blíster.



JUEGO DE LLAVES ALLEN DE BOLA CON MANGO, SERIE EXTRALARGA



SERIE EXTRALARGA

- Incluye un mango de plástico con orificios que permiten insertarlo por ambos extremos de la llave allen de bola y utilizar la llave como si fuera un mango en T o un destornillador.

COMPOSICIÓN

1.5, 2, 2.5, 3, 4, 5, 6, 8, 10 mm.



Mango en T



Atornillador

Cód.	Nº piezas	P.V.P. unid. €	
170612	10	15,12	6

Se suministra en blíster.



Mango de fuerza





LLAVE TORX ACODADA



■ Terminación niquelado.



LLAVE TORX ACODADA INVIOLEBLE



■ Terminación niquelado.

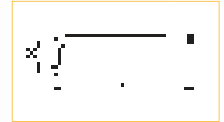
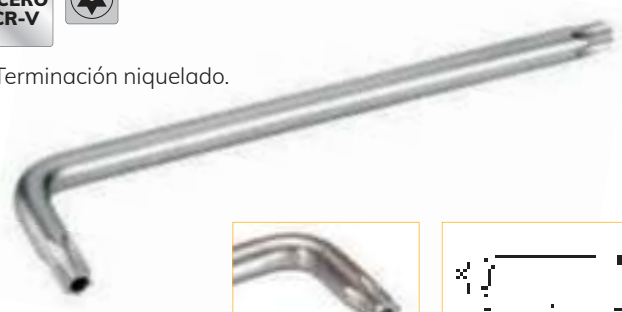

05

Cód.	★	L mm	S mm	P.V.P. unid. €	
193206	T6	66	16	3,23	10
193207	T7	71	16	3,23	10
193208	T8	76	16	3,23	10
193209	T9	80	16	3,23	10
193210	T10	86	17	3,23	10
193215	T15	90	18	3,23	10
193220	T20	95	19	3,32	10
193225	T25	100	20	3,36	10
193227	T27	105	21	3,38	10
193230	T30	114	24	3,43	10
193240	T40	124	26	3,67	5
193245	T45	137	29	3,82	5
193250	T50	152	32	4,17	5
193255	T55	171	35	5,65	5
193260	T60	190	38	6,91	5

Cód.	★	L mm	S mm	P.V.P. unid. €	
194006	T6	66	16	5,00	10
194007	T7	71	16	5,00	10
194008	T8	76	16	5,00	10
194009	T9	80	16	5,05	10
194010	T10	86	17	5,05	10
194015	T15	90	18	5,05	10
194020	T20	95	19	5,07	10
194025	T25	100	20	5,07	10
194027	T27	105	21	5,07	10
194030	T30	114	24	5,07	10
194040	T40	124	26	5,07	5
194045	T45	137	29	5,07	5
194050	T50	152	32	5,44	5
194055	T55	171	35	7,34	5
194060	T60	190	38	8,99	5



JUEGO DE LLAVES TORX, SOPORTE DE PLÁSTICO



COMPOSICIÓN

T10, T15, T20, T25, T27, T30, T40, T45, T50.

SERIE NORMAL



Cód.	Nº piezas	P.V.P. unid. €	
193270	9	11,91	6

Se suministra en blíster.



JUEGO DE LLAVES TORX INVIOLEBLES, SOPORTE DE PLÁSTICO



COMPOSICIÓN

T10, T15, T20, T25, T27, T30, T40, T45, T50.

SERIE NORMAL



Cód.	Nº piezas	P.V.P. unid. €	
193290	9	14,81	6

Se suministra en blíster.



JUEGO DE LLAVES TORX INVOLABLES, SOPORTE DE PLÁSTICO



SERIE EXTRALARGA

COMPOSICIÓN

T10, T15, T20, T25, T27, T30, T40, T45, T50.

Cód.	Nº piezas	P.V.P. unid. €	
193292	9	20,24	6

Se suministra en blíster.



05



JUEGO DE LLAVES TORX INVOLABLES, SOPORTE DE PLÁSTICO



SERIE LARGA

COMPOSICIÓN

T9, T10, T15, T20, T27, T30, T40, T50, T55.

Cód.	Nº piezas	P.V.P. unid. €	
170615	9	13,10	6

Se suministra en blíster.



JUEGO DE LLAVES TORX INVOLABLES EN NAVAJA



COMPOSICIÓN

T9, T10, T15, T20, T25, T27, T30, T40.

Cód.	Nº piezas	P.V.P. unid. €	
193283	8	16,67	6

Se suministra en blíster.



JUEGO DE LLAVES TORX INVOLABLES EN NAVAJA



COMPOSICIÓN

T9, T10, T15, T20, T25, T27, T30, T40.

Cód.	Nº piezas	P.V.P. unid. €	
170617	8	7,73	6

Se suministra en colgador.



Soporte Aluminio Anodizado





MANGO EN T HEXAGONAL BOLA DIAMANTE

ACERO CR-V



- Mango ergonómico bimaterial para grandes pares de apriete.
- Con agujero para colgar.
- Terminación satinado mate.



PERFIL DE DIAMANTE

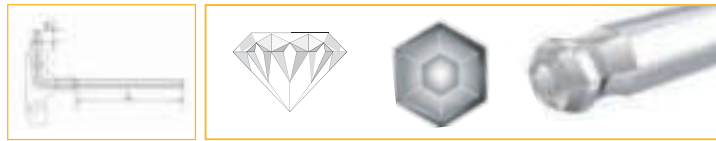

Cód.	mm	H x L mm	P.V.P. unid. €	
195261	1,5	12x100	3,92	6
195262	2	12x100	3,92	6
195271	2,5	12x100	3,98	6
195263	3	15x100	4,04	6
195264	4	15x100	4,83	6
195265	5	15x150	5,23	6
195266	6	15x150	5,58	6
195268	8	20x200	7,82	6
195270	10	20x200	9,04	6

05



MANGO EN T TORX INVOLABLE

ACERO CR-V



Cód.		H x L mm	P.V.P. unid. €	
195309	T9	15x100	5,31	6
195310	T10	15x100	5,31	6
195315	T15	15x100	5,44	6
195320	T20	15x100	5,49	6
195325	T25	15x100	6,51	6
195327	T27	15x150	6,69	6
195330	T30	15x150	7,08	6
195340	T40	20x200	7,56	6
195350	T50	20x200	12,20	6

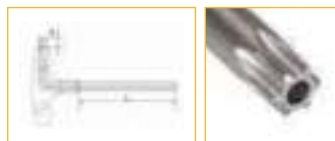

JUEGO DE MANGOS EN T HEXAGONALES BOLA DIAMANTE



COMPOSICIÓN

2, 2.5, 3, 4, 5, 6, 8, 10 mm.

Cód.	Nº piezas	P.V.P. unid. €	
195274	8	42,87	1





MANGO EN T HEXAGONAL



Cód.	mm	P.V.P. unid. €	
171202	2	2,16	12
171225	2,5	2,50	12
171203	3	2,75	12
171204	4	3,16	12
171205	5	3,50	12
171206	6	4,60	12
171208	8	6,30	12



Se suministra en colgador.

05



MANGO EN T HEXAGONAL AISLADO



Cód.	mm	L x C mm	P.V.P. unid. €	
190442	2,5	100x80	9,60	6
190443	3	100x80	10,18	6
190444	4	125x100	12,82	6
190445	5	150x100	13,38	6
190446	6	175x120	15,67	6
190448	8	200x120	18,96	6



CERTIFICADO VDE

NORMA EN 60900:
Herramientas aisladas utilizadas para trabajos en tensiones de hasta 1000V en Corriente Alterna ó 1500V en Corriente Continua.



MANGO EN T CON VASO HEXAGONAL



Cód.	mm	P.V.P. unid. €	
195205	5	8,48	6
195255	5,5	8,48	6
195206	6	8,48	6
195207	7	8,48	6
195208	8	8,78	6
195209	9	8,78	6
195210	10	9,79	6
195211	11	9,79	6
195212	12	10,82	6
195213	13	10,82	6
195214	14	11,56	6



Hexágono conductor forjado para grandes pares de apriete.



MANGO EN T CON VASO HEXAGONAL LARGO



Cód.	mm	P.V.P. unid. €	
195227	7	9,75	6
195228	8	10,09	6
195230	10	11,28	6
195232	12	12,46	6
195233	13	12,46	6

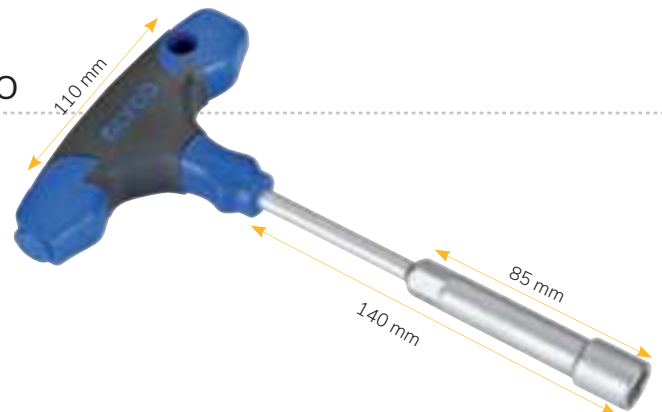



MANGOS EN T CON ADAPTADOR

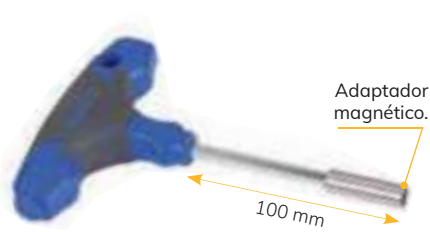

Cód.	P.V.P. unid. €	
195245	9,15	6

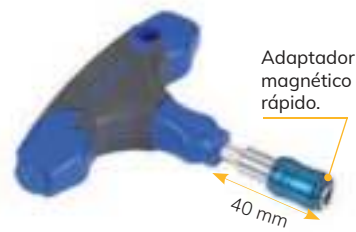

Cód.	P.V.P. unid. €	
195250	10,28	6

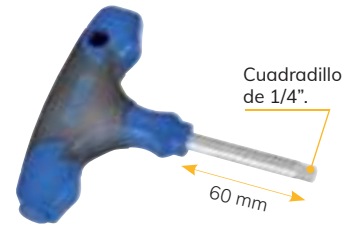

Cód.	P.V.P. unid. €	
195240	7,45	12

05



JUEGO DE MANGOS EN T INTERCAMBIABLES

ACERO
CR-V-MO

- Varillas de 125 mm de longitud con doble punta.
- Mango ergonómico bicomponente.

COMPOSICIÓN

1 Mango en T intercambiable.
 10 Varillas con doble punta:
 Recta \ominus 3,0- \ominus 4,0 / \ominus 5,5- \ominus 6,5
 Hexagonal \bullet 3,0- \bullet 4,0 / \bullet 5,0- \bullet 6,0
 \oplus PH1- \oplus PH2 / \oplus PZ1- \oplus PZ2 / \oplus PH3- \oplus PZ3
 \otimes T10- \otimes T15 / \otimes T20- \otimes T25 / \otimes T30- \otimes T40



Cód.	Nº piezas	P.V.P. unid. €	
195284	11	26,14	1



JUEGO DE MANGOS EN T EN BOLSA DE NYLON



COMPOSICIÓN

8 Mangos en T hexagonales:
 1,5, 2, 2,5, 3, 4, 5, 6, 8 mm.
 1 Adaptador magnético con mango en T.
 10 Puntas 1/4: \ominus 4, 5, 6 mm / \oplus PH1, PH2
 \oplus PZ1, PZ2 / \otimes T10, T15, T20.
 1 Adaptador vasos 1/4".

Cód.	Nº piezas	P.V.P. unid. €	
195282	20	64,61	2



Incluye 20 bocas diferentes

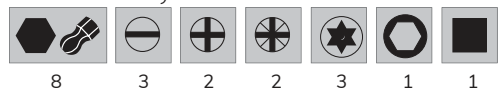

06

DESTORNILLADORES Y PUNTAS

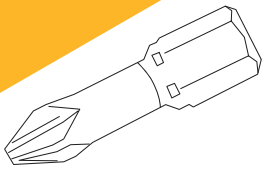

Punta de atornillar **164**

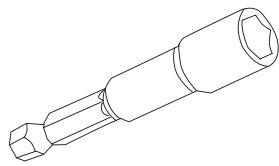

Vaso y adaptador magnético **168**

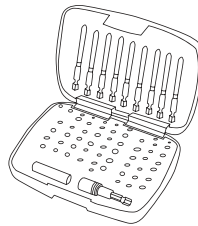

Juego de puntas **169**

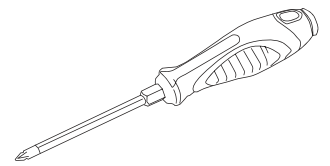

Destornillador varilla pasante **171**

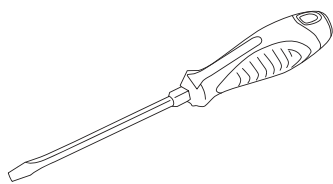

Destornillador **172**

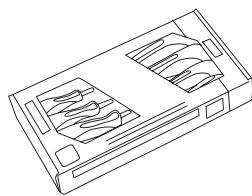

Juego destornilladores **174**

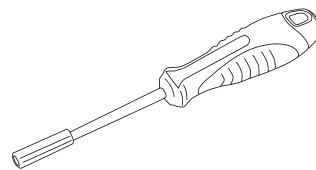

Adaptador magnético **176**

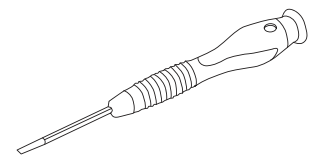

Destornillador de precisión **182**

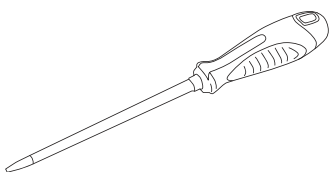

Destornillador aislado **184**

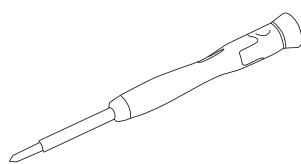

Destornillador precisión aislado **187**

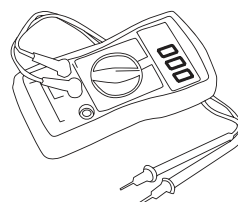

Polímetro **188**

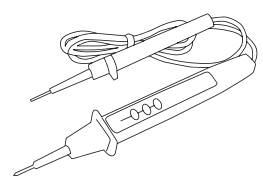

Tester **188**

CARACTERÍSTICAS DE LAS PUNTAS

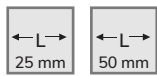

Longitud total de la punta



TIN
Titanio
Recubrimiento superficial de titanio (mayor resistencia al desgaste)



TIPOS DE PUNTA



Forma estándar de la zona de amarre de la punta



Antides.
Punta con resaltes para evitar deslizamientos durante el trabajo



Torsión
Forma especial del cuerpo de la punta para evitar sobrecargas y posibles roturas



TODAS LAS PUNTAS EN DISPENSADORES DE PLÁSTICO

06



PUNTA DE 1/4" DE 25 MM

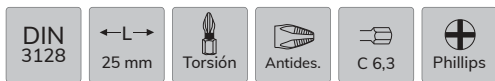

Cód.	+	P.V.P. unid. €	
193536	PH1	9,42	1
193537	PH2	9,42	1
193538	PH3	9,42	1

Unidad de venta envase de 10 unidades.



Cód.	+	P.V.P. unid. €	
193546	PH1	23,95	1
193547	PH2	23,95	1
193548	PH3	23,95	1

Unidad de venta envase de 10 unidades.



Cód.	+	P.V.P. unid. €	
193556	PZ1	9,42	1
193557	PZ2	9,42	1
193558	PZ3	9,42	1

Unidad de venta envase de 10 unidades.



Cód.	+	P.V.P. unid. €	
193566	PZ1	23,95	1
193567	PZ2	23,95	1
193568	PZ3	23,95	1

Unidad de venta envase de 10 unidades.



* Puntas tipo torsión.

Cód.	Hex	P.V.P. unid. €	
193570	1,5*	10,70	1
193572	2*	10,70	1
193571	2,5*	10,70	1
193573	3*	10,70	1
193574	4*	10,70	1

Cód.	Hex	P.V.P. unid. €	
193575	5*	10,70	1
193576	6	10,70	1
193578	8	13,72	1**
193580	10	15,29	1**

Unidad de venta envase de 10 unidades.
** Unidad de venta envase de 5 unidades.

PUNTA DE 1/4" DE 25 MM



* Puntas tipo torsión.

Cód.	★	P.V.P. unid. €	
193581	T10*	10,72	1
193582	T15*	10,72	1
193583	T20*	10,72	1
193584	T25*	10,72	1
193585	T27*	10,72	1
193586	T30*	10,72	1
193587	T40	5,92	1**
193588	T45	6,83	1**
193589	T50	7,23	1**
193603	T55	7,24	1**

Unidad de venta envase de 10 unidades.
** Unidad de venta envase de 5 unidades.



Cód.	★	P.V.P. unid. €	
193590	T10	12,21	1
193591	T15	12,21	1
193592	T20	12,21	1
193593	T25	12,21	1
193594	T27	12,21	1
193595	T30	12,21	1
193596	T40	6,10	1**
193597	T45	7,25	1**
193598	T50	7,66	1**
193599	T55	7,97	1**

Unidad de venta envase de 10 unidades.
** Unidad de venta envase de 5 unidades.



06

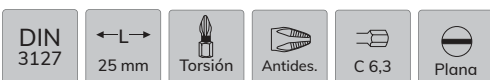

Cód.	⌀ mm	P.V.P. unid. €	
193503	0,6x4,5	11,41	1
193506	0,8x5,5	11,41	1
193511	1,0x5,5	11,41	1
193516	1,2x6,5	11,41	1
193521	1,6x8,0	11,41	1

Unidad de venta envase de 10 unidades.

PUNTA DE 1/4" DE 50 MM

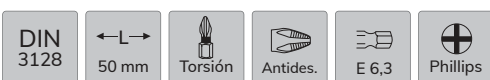

Cód.	⊕	P.V.P. unid. €	
193636	PH1	23,03	1
193637	PH2	23,03	1
193638	PH3	23,03	1

Unidad de venta envase de 10 unidades.



Cód.	⊕	P.V.P. unid. €	
193646	PH1	35,59	1
193647	PH2	35,59	1
193648	PH3	35,59	1

Unidad de venta envase de 10 unidades.

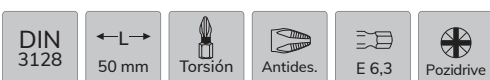

Cód.	⊕	P.V.P. unid. €	
193656	PZ1	23,02	1
193657	PZ2	23,02	1
193658	PZ3	23,02	1

Unidad de venta envase de 10 unidades.



Cód.	⊕	P.V.P. unid. €	
193666	PZ1	35,59	1
193667	PZ2	35,59	1
193668	PZ3	35,59	1

Unidad de venta envase de 10 unidades.



PUNTA DE 1/4" DE 50 MM

DIN 3127 50 mm Torsión Antides. E 6,3 Plana



Cód.	mm	P.V.P. unid. €	
193601	0,6x4,5	28,63	1
193606	0,8x5,5	28,63	1
193611	1,0x5,5	28,63	1
193616	1,2x6,5	28,63	1
193621	1,6x8,0	28,63	1

Unidad de venta envase de 10 unidades.



PUNTA DE 1/4" DE 100 MM

DIN 3128 100 mm Antides. E 6,3 Phillips



Cód.		P.V.P. unid. €	
193964	PH1	22,41	1
193965	PH2	26,90	1

193964 Unidad de venta envase de 5 unidades.
193965 Unidad de venta envase de 6 unidades.



PUNTA DE 1/4" DE 150 MM

DIN 3128 150 mm Antides. E 6,3 Phillips



Cód.		P.V.P. unid. €	
193967	PH1	28,69	1
193968	PH2	28,69	1

Unidad de venta envase de 5 unidades.

06



PUNTA DE 5/16" DE 30 MM

Plana L: 30 mm

Cód.	mm	P.V.P. unid. €	
193935	5,5	9,30	1
193936	6,5	9,30	1
193938	8,0	9,30	1
193940	10,0	12,18	1
193942	12,0	16,71	1

Unidad de venta envase de 5 unidades.

Phillips L: 30 mm

Cód.		P.V.P. unid. €	
193961	PH1	9,30	1
193962	PH2	9,30	1
193963	PH3	9,30	1

Unidad de venta envase de 5 unidades.

Pozidrive L: 30 mm

Cód.		P.V.P. unid. €	
193971	PZ1	9,30	1
193972	PZ2	9,30	1
193973	PZ3	9,30	1

Unidad de venta envase de 5 unidades.

Hex. L: 30 mm

Cód.	mm	P.V.P. unid. €	
193944	4	9,30	1
193945	5	9,30	1
193946	6	9,30	1
193948	8	9,30	1
193950	10	11,92	1
193952	12	16,71	1
193954	14	24,41	1

Unidad de venta envase de 5 unidades.

Torx Inv. L: 30 mm

Cód.		P.V.P. unid. €	
193990	T20	11,92	1
193991	T25	11,92	1
193992	T27	11,92	1
193993	T30	11,92	1
193994	T40	11,92	1
193995	T45	11,92	1
193996	T50	11,92	1

Unidad de venta envase de 5 unidades.

XZN L: 30 mm

Cód.		P.V.P. unid. €	
193980	M4	14,94	1
193981	M5	14,94	1
193982	M6	14,94	1
193983	M8	14,94	1
193984	M10	18,99	1
193985	M12	27,38	1

Unidad de venta envase de 5 unidades.

PUNTA DE 3/8" DE 30 MM



L: 30 mm



L: 30 mm



L: 30 mm



Cód.	Icono	P.V.P. unid. €	Paquete
186123	T20	23,84	1
186125	T25	23,84	1
186130	T30	23,84	1
186140	T40	23,84	1
186145	T45	23,84	1
186150	T50	23,84	1
186155	T55	23,84	1
186160	T60	23,84	1

Unidad de venta envase de 10 unidades.

Cód.	mm	P.V.P. unid. €	Paquete
186104	4	18,59	1
186105	5	18,59	1
186106	6	18,59	1
186107	7	18,59	1
186108	8	18,59	1
186110	10	23,84	1
186112	12	28,56	1

Unidad de venta envase de 10 unidades.

Cód.	Icono	P.V.P. unid. €	Paquete
186165	M5	30,54	1
186166	M6	30,54	1
186168	M8	30,54	1
186170	M10	37,98	1
186172	M12	48,54	1

Unidad de venta envase de 10 unidades.

06

PUNTA DE 3/8" DE 75 MM



L: 75 mm



L: 75 mm



L: 75 mm



Cód.	Icono	P.V.P. unid. €	Paquete
186124	T20	32,51	1
186126	T25	32,51	1
186131	T30	32,51	1
186141	T40	32,51	1
186146	T45	32,51	1
186151	T50	32,51	1
186156	T55	32,51	1
186161	T60	38,59	1

Unidad de venta envase de 10 unidades.

Cód.	mm	P.V.P. unid. €	Paquete
186114	4	32,51	1
186115	5	32,51	1
186116	6	32,51	1
186117	7	32,51	1
186118	8	32,51	1
186120	10	32,51	1
186122	12	37,76	1

Unidad de venta envase de 10 unidades.

Cód.	Icono	P.V.P. unid. €	Paquete
186175	M5	32,51	1
186176	M6	32,51	1
186178	M8	32,51	1
186180	M10	32,51	1
186182	M12	38,59	1

Unidad de venta envase de 10 unidades.

JUEGO DE PUNTAS DE 3/8"



ESPECIAL AUTOMOCIÓN

COMPOSICIÓN

- 20 puntas 3/8" 30mm:
 - 7 ● Hex. 4, 5, 6, 7, 8, 10, 12 mm.
 - 5 ● XZN M5, M6, M8, M10, M12.
 - 8 ● Torx T20, T25, T30, T40, T45, T50, T55, T60.
 - 1 Adap. 3/8" H para puntas 3/8".
- 20 puntas 3/8" 75mm:
 - 7 ● Hex 4, 5, 6, 7, 8, 10, 12 mm.
 - 5 ● XZN M5, M6, M8, M10, M12.
 - 8 ● Torx T20, T25, T30, T40, T45, T50, T55, T60.
 - 1 Adap. 1/2" H para puntas 3/8".



Incluye tres tipos de bocas



Cód.	Nº piezas	P.V.P. unid. €	Paquete
186100	42	42,17	1



VASO MAGNÉTICO. ACOPLAMIENTO RÁPIDO 1/4"

ACERO CR-V



Cód.	mm	P.V.P. unid. €	
194805	5,5	3,63	6
194806	6	3,63	6
194807	7	3,63	6
194808	8	3,63	6
194809	9	3,63	6
194810	10	4,00	6
194811	11	4,10	6
194812	12	4,20	6
194813	13	4,25	6



Con imán en la parte interior para una mejor fijación del vaso.

L: 63 mm

Se suministra en estuche con colgador.

06



JUEGO DE VASOS MAGNÉTICOS 1/4"

COMPOSICIÓN

5.5, 6, 7, 8, 9, 10, 11, 12, 13 mm.

Cód.	Nº piezas	P.V.P. unid. €	
194815	9	31,99	6

Se suministra en blíster.



ADAPTADOR PARA VASOS



Cód.		L mm	P.V.P. unid. €	
193751	1/4"	50	4,56	10
193752	3/8"	50	5,48	10
193753	1/2"	60	5,93	6



ADAPTADOR MAGNÉTICO 1/4"



Cód.	L mm	P.V.P. unid. €	
193740	60	5,23	6
193742	100	6,84	6
193744	150	9,13	6

Se suministra en estuche con colgador.



ADAPTADOR CON ACOPLAMIENTO RÁPIDO 1/4"

No imantado.



Cód.	L mm	P.V.P. unid. €	
193750	60	5,82	6

Se suministra en estuche con colgador.



ADAPTADOR PARA VASOS DE 1/4"



Cód.	L mm	P.V.P. unid. €	
193754	30	1,71	10



JUEGO DE PUNTAS 1/4"

ACERO CR-V

COMPOSICIÓN

- 59 Puntas 1/4" 25 mm: 4 4, 5, 6, 7.
- 6 PZ1(2), PZ2(2), 4 4, 5, 6, 8.
- PZ3(2), 4 1, 2, 3, 4.
- 6 PH1(2), PH2(2), 9 Puntas 1/4" 75 mm:
- PH3(2), 2 PZ1, PZ2.
- 9 T10, T15(2), T20(2), 3 PH1, PH2, PH3.
- T25(2), T27, T30, 2 T20, T25.
- 6 4(2), 5(2), 6(2), mm. 2 4, 6 mm.
- 6 4(2), 5(2), 6(2), mm. 1 Adaptador magnético rápido.
- 4 0, 1, 2, 3. 1 Adaptador magnético.
- 3 6, 8, 10. 1 Avellanador.
- 3 1, 2, 3.
- 4 4, 6, 8, 10.

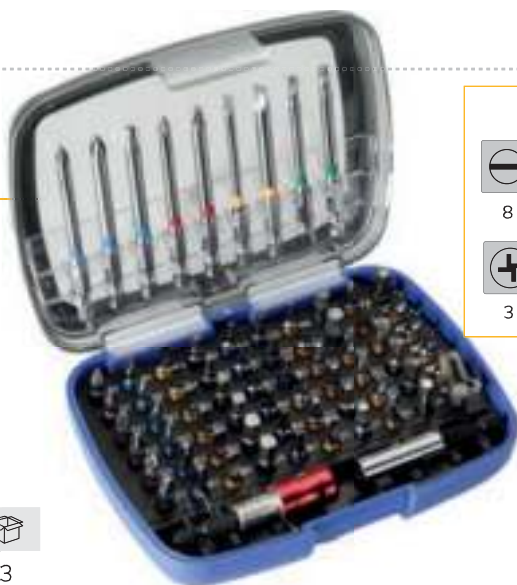

Incluye 12 bocas diferentes

8	9	8	6	11	4
3	3	4	4	4	4

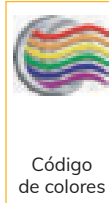

Cód.	Nº piezas	P.V.P. unid. €	
193730	71	36,84	3

Se suministra en blíster.

06



JUEGO DE PUNTAS 1/4"

ACERO CR-V

COMPOSICIÓN

- 30 puntas 1/4":
- 4 PH1, PH2 (2), PH3.
- 4 PZ1, PZ2 (2), PZ3.
- 4 3, 4, 5, 6 mm.
- 4 3, 4, 5, 6 mm.
- 7 T10, T15, T20, T25, T27, T30, T40.
- 7 T10, T15, T20, T25, T27, T30, T40.
- 1 Adaptador magnético rápido.
- 1 Adaptador puntas 1/4".



Incluye 6 bocas diferentes

4	4	4	4	7	7

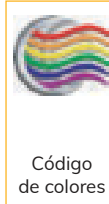

Cód.	Nº piezas	P.V.P. unid. €	
193725	32	19,98	6

Se suministra en blíster.



JUEGO DE DESTORNILLADOR CON CARRACA Y PUNTAS

COMPOSICIÓN

- 48 puntas 1/4" 25mm:
- 8 3(1), 4(2), 5(2), 6(2), 7(1) mm.
- 8 PH0(2), PH1(2), PH2(2), PH3(2).
- 8 PZ0(2), PZ1(2), PZ2(2), PZ3(2).
- 8 T8, T10, T15, T20, T25, T27, T30, T40.
- 8 T8, T10, T15, T20, T25, T27, T30, T40.
- 8 1.5, 2, 2.5, 3, 4, 5, 5.5, 6 mm.
- 1 Adapt. magnético 100 mm.
- 1 Adapt. magnético rápido 60 mm.
- 1 Adapt. para vasos 1/4" 50 mm.
- 1 Adapt. para puntas de 1/4".
- 32 puntas 1/4" 50mm:
- 8 3, 4, 5, 6(4), 7 mm.
- 4 PH1, PH2(2), PH3.
- 4 PZ1, PZ2(2), PZ3.
- 10 T10, T15(2), T20(2), T25(2), T27, T30, T40.
- 6 2.5, 3, 4, 5, 5.5, 6 mm.
- 1 Avellanador de 1/4".
- 1 Mango atornillador con carraca.
- 10 Vasos magnéticos 1/4": 4, 5, 6, 7, 8, 9, 10, 11, 12, 13 mm.

INCLUYE ADAPTADOR MAGNÉTICO DE 100 MM PARA UNIR AL MANGO ATORNILLADOR

Incluye 6 bocas diferentes

16	12	12	14	18	8



Cód.	Nº piezas	P.V.P. unid. €	
119150	96	70,41	1



JUEGO DE PUNTAS 1/4" CON ADAPTADOR

ACERO CR-V

Incluye 5 bocas especiales



COMPOSICIÓN

1 Adaptador para Puntas 1/4" magnético.

84 Puntas 1/4" 25 mm:

14 ● T6, T7, T8, T9, T10, T15, T20, T25, T27, T30, T35, T40, T45, T50.

10 ⊕ T10, T15, T20, T25, T27, T30, T35, T40, T45, T50.

12 ● 1.5, 2, 2.5, 3, 4, 5, 5.5, 6, 7, 8, 10, 12.

9 ⊖ 3, 4, 4.5, 5, 5.5, 6, 6.5, 7, 8 mm.

9 ⊕ PH0, PH1(2), PH2(3), PH3(2), PH4.

9 ⊕ PZ0, PZ1(2), PZ2(3), PZ3(2), PZ4.

5 ⊖ 4, 6, 8, 10, 12.

3 ⊕ 6, 8, 10.

4 ⊖ 0, 1, 2, 3.

5 ⊕ 1, 2, 3, 4, 5.

4 ● 4, 5, 6, 8.

Cód.	Nº piezas	P.V.P. unid. €	
170492	85	27,87	5

06



JUEGO DE PUNTAS 1/4" CON ADAPTADOR

ACERO CR-V

COMPOSICIÓN

1 Adaptador para puntas 1/4" magnético.

30 Puntas 1/4" 25 mm:

10 ● T7, T8, T9, T10, T15, T20, T25, T27, T30, T40.

4 ⊕ PH0, PH1, PH2, PH3.

3 ⊖ 1, 2, 3.

5 ● 2, 3, 4, 5, 6.

3 ⊕ PZ1, PZ2, PZ3.

5 ⊖ 3.5, 4.5, 5.0, 5.5, 6.5 mm.

Cód.	Nº piezas	P.V.P. unid. €	
170490	31	14,58	6



JUEGO DE PUNTAS 1/4" CON ADAPTADOR

ACERO CR-V

COMPOSICIÓN

1 Adaptador para puntas 1/4" magnético.

9 Puntas 1/4" 25 mm:

3 ● T15, T20, T25.

2 ⊕ PH1, PH2.

2 ⊖ 5, 6.5.

2 ⊕ PZ1, PZ2.

Cód.	Nº piezas	P.V.P. unid. €	
170494	10	6,24	12

Se suministra en blíster.



Posibilidad de utilizar como mango en T.



LLAVE ACODADA DOBLE USO

ACERO CR-V

- Llave templada por inducción.
- Cuerpo moleteado para mejor agarre.

COMPOSICIÓN

1 ⊖ 5 / ⊕ PH1

1 ⊖ 6 / ⊕ PH2

Cód.	Nº piezas	P.V.P. unid. €	
170695	2	2,63	12



DESTORNILLADOR BOCA PLANA CON VARILLA PASANTE

DIN 5265

ACERO CR-V S2



Punta negra magnética.

Varilla hexagonal. Acero especial S2 (gran resistencia al desgaste).

Mango ergonómico con 4 materiales diferentes.

Tope superior con alojamiento hexagonal de 8 mm.

Cód.	Ø mm	Ø mm	mm	P.V.P. unid. €	📦
119205	5,5	1,0	125	7,63	12
119206	6,5	1,2	150	8,70	12
119208	8,0	1,2	150	10,42	12

Se suministra con colgador.



Varilla pasante con tope superior forjado.



Hexágono conductor. Fabricado en 2 piezas. Mayor par de apriete.

06

DESTORNILLADOR BOCA PHILLIPS CON VARILLA PASANTE

DIN 5262

ACERO CR-V S2



Cód.	+	mm	P.V.P. unid. €	📦
119231	PH1	100	6,78	12
119232	PH2	150	8,38	12

Se suministra con colgador.

DESTORNILLADOR BOCA POZIDRIVE CON VARILLA PASANTE

DIN 5262

ACERO CR-V S2



Cód.	+	mm	P.V.P. unid. €	📦
119241	PZ1	100	7,67	12
119242	PZ2	150	8,96	12

Se suministra con colgador.

JUEGO DE DESTORNILLADORES PASANTE

COMPOSICIÓN

Tope superior / Hex. Conductor / Varilla hexagonal.

- 5.5 x 100 mm / 6.5 x 125 mm (Boca plana).
- PH1 x 80 mm / PH2 x 100 mm.
- PZ1 x 80 mm / PZ2 x 100 mm.

3 x 75 mm* / 4 x 80 mm (Boca recta)*.

* Sin tope superior, hexágono conductor ni varilla hexagonal. Con varilla cilíndrica.

Cód.	Nº piezas	P.V.P. unid. €	📦
119201	8	52,67	1





DESTORNILLADOR BOCA PLANA



- Terminación cromado satinado mate.
- Mango ergonómico de gran volumen.
- Tope superior con símbolo del tipo de punta.



Cód.	Ø mm	mm	mm	P.V.P. unid. €	
119004	4,0*	0,8	80	3,99	12
119005	5,5	1,0	125	5,17	12
119007	6,5	1,2	100	6,28	12
119006	6,5	1,2	150	6,87	12
119008	8,0	1,2	150	8,19	12
119010	10,0*	1,6	200	9,79	12

* Destornillador con varilla cilíndrica y sin hexágono conductor.

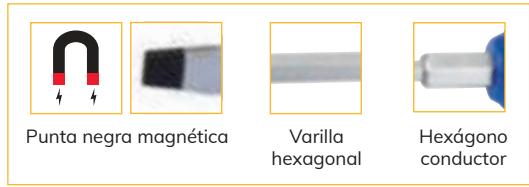

06



DESTORNILLADOR BOCA RECTA



Cód.	Ø mm	mm	mm	P.V.P. unid. €	
119022	2,5	0,4	75	3,20	12
119023	3,0	0,5	100	3,27	12
119024	4,0	0,8	100	4,01	12
119025	5,0	0,8	150	5,34	12



CON VARILLA CILÍNDRICA Y SIN HEXÁGONO CONDUCTOR.



DESTORNILLADOR BOCA PHILLIPS



Cód.		mm	P.V.P. unid. €	
119030	PH0*	75	3,53	12
119031	PH1	100	4,91	12
119029	PH2	100	5,83	12
119032	PH2	150	6,13	12
119033	PH3	150	9,20	12

* Destornillador con varilla cilíndrica y sin hexágono conductor.



DESTORNILLADOR BOCA POZIDRIVE

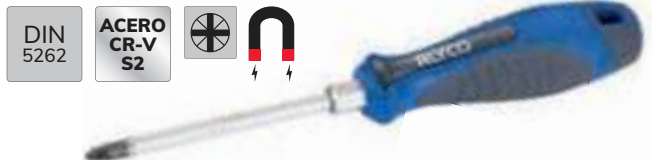

Cód.		mm	P.V.P. unid. €	
119040	PZ0*	75	4,30	12
119041	PZ1	100	5,23	12
119042	PZ2	150	6,62	12
119043	PZ3	150	9,63	12

* Destornillador con varilla cilíndrica y sin hexágono conductor.



DESTORNILLADOR BOCA TORX INVOLABLE



Cód.		mm	P.V.P. unid. €	
119091	T10	80	5,27	12
119092	T15	80	5,41	12
119093	T20	100	5,41	12
119094	T25	100	5,67	12
119095	T27	100	5,76	12
119096	T30	100	6,75	12
119097	T40	125	7,83	12
119098	T45	125	8,82	12



DESTORNILLADOR BOCA RECTA. SERIE CORTA



Cód.	Ø mm	Ø mm	mm	P.V.P. unid. €	📦
119012	5,5	1,0	38	4,85	12
119014	6,5	1,2	38	6,23	12

DESTORNILLADOR BOCA PHILLIPS. SERIE CORTA

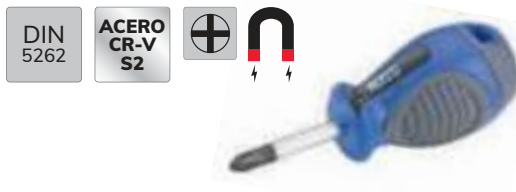

Cód.	Tip	mm	P.V.P. unid. €	📦
119035	PH1	38	4,57	12
119036	PH2	38	5,78	12

DESTORNILLADOR BOCA RECTA. SERIE LARGA

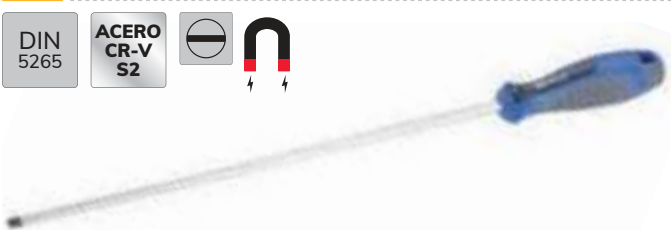

Cód.	Ø mm	Ø mm	mm	P.V.P. unid. €	📦
119016	4,0	0,8	250	5,98	12
119018	6,0	1,0	300	8,65	12

DESTORNILLADOR BOCA PHILLIPS. SERIE LARGA



Cód.	Tip	mm	P.V.P. unid. €	📦
119038	PH1	250	6,46	12
119039	PH2	300	8,14	12

06

DESTORNILLADOR CON VASO HEXAGONAL



Cód.	Ø	mm	P.V.P. unid. €	📦
119074	5	150	6,81	12
119075	5,5	150	6,81	12
119076	6	150	6,94	12
119077	7	150	7,11	12
119078	8	150	7,52	12
119079	9	150	8,19	12
119080	10	150	8,56	12
119081	11	150	8,88	12
119082	12	150	9,12	12
119083	13	150	9,12	12
119084	14	150	9,12	12



Hexágono conductor para accionar con llave y utilizar en trabajos que requieren gran par de apriete.

MAGNETIZADOR - DESMAGNETIZADOR

■ Magnetiza pequeñas herramientas para extraer fácilmente todo tipo de tornillos y tuercas.

Cód.	Medida mm	P.V.P. unid. €	📦
121530	52x50x28	2,01	6



Para desmagnetizar introducir lentamente a través de la abertura señalizada con (-).



Para magnetizar introducir lentamente a través de la abertura señalizada con (+).

Se suministra en blíster.



JUEGO DE DESTORNILLADORES

COMPOSICIÓN

- 2 ⊖ 3x100 mm* / 4x100 mm (recta)*.
 - 2 ⊖ 5.5x125 mm**/ 6.5x150 mm (plana)**.
 - 2 ⊕ PH0x75 mm* / PH1x100 mm**.
- * Con varilla cilíndrica. Sin hexágono conductor.
 ** Con varilla hexagonal y hexágono conductor.



Cód.	Nº piezas	P.V.P. unid. €	
119050	6	27,27	1

06



JUEGO DE DESTORNILLADORES

COMPOSICIÓN

- 2 ⊖ 3x100 mm* / 4x100 mm (recta)*.
 - 2 ⊖ 5.5x125 mm**/ 6.5x150 mm (plana)**.
 - 2 ⊕ PH0x75 mm* / PH1x100 mm**.
- * Con varilla cilíndrica. Sin hexágono conductor.
 ** Con varilla hexagonal y hexágono conductor.



Cód.	Nº piezas	P.V.P. unid. €	
119049	6	27,02	1



JUEGO DE DESTORNILLADORES

COMPOSICIÓN

- 1 ⊖ 3x100 mm (Boca recta)*.
 - 3 ⊖ 4x80 mm*/ 6.5x150 mm**/ 8x150 mm** (Boca plana).
 - 2 ⊕ PH1x100 mm** / PH2x150 mm**.
 - 2 ⊕ PZ1x100 mm**/ PZ2x150 mm**.
- * Con varilla cilíndrica. Sin hexágono conductor.
 ** Con varilla hexagonal y hexágono conductor.



Cód.	Nº piezas	P.V.P. unid. €	
119055	8	45,14	1



JUEGO DE DESTORNILLADORES

COMPOSICIÓN

- 2 ⊖ 3x100 mm* / 4x100 mm (Boca recta)*.
 - 3 ⊖ 5.5x100 mm**/ 6.5x125 mm**/ 6.5x38 mm*.
 - 3 ⊕ PH1x100 mm** / PH2x100 mm** / PH2x38 mm*.
 - 2 ⊕ PZ1x100 mm** / PZ2x100 mm**.
- * Con varilla cilíndrica. Sin hexágono conductor.
 ** Con varilla hexagonal y hexágono conductor.



Cód.	Nº piezas	P.V.P. unid. €	
119090	10	47,96	1

Medida caja: 255x185x48 mm.

JUEGO DESTORNILLADORES PUNTA PLANA



COMPOSICIÓN

3x100 mm* (B. recta), 4x80*, 5.5x125**, 6.5x150**, 8x150**.
 * Con varilla cilíndrica. Sin hexágono conductor.
 ** Con varilla hexagonal y hexágono conductor.

Cód.	Nº piezas	P.V.P. unid. €	
119057	5	27,43	1

JUEGO DESTORNILLADORES PUNTA PHILLIPS



COMPOSICIÓN

PH0x75*, PH1x100**, PH2x150**, PH3x150**, PH4x200 mm**.
 * Con varilla cilíndrica. Sin hexágono conductor.
 ** Con varilla hexagonal y hexágono conductor.

Cód.	Nº piezas	P.V.P. unid. €	
119058	5	31,99	1

06

JUEGO DESTORNILLADORES TORX INVIOLEBLE



COMPOSICIÓN

⊕ T10x80, T15x80, T20x100, T25x100, T30x100, T40x125.

Cód.	Nº piezas	P.V.P. unid. €	
119099	6	36,33	6

JUEGO DESTORNILLADORES CON VASO



COMPOSICIÓN

⊖ 6, 8, 10, 11, 12, 13 x 150 mm.

Cód.	Nº piezas	P.V.P. unid. €	
119085	6	48,08	1

JUEGO DESTORNILLADORES, BOLSA NYLON

COMPOSICIÓN

2 ⊖ 3x100* / 4x100 mm* (boca recta).
 3 ⊖ 5.5x125** / 6.5x150 mm** / 6.5x38 mm* (plana).
 3 ⊕ PH1x100**/ PH2x150 mm** / PH2x38 mm*.
 2 ⊕ PZ1x100**/ PZ2x150 mm**.
 1 Adaptador para Vasos 1/4".
 1 Adaptador magnético con mango.
 10 Puntas de 1/4" 25 mm.
 4 ● Hexagonal 3,4,5,6 mm.
 6 ⊕ Torx T10, T15, T20, T25, T30, T40.
 * Con varilla cilíndrica. Sin hexágono conductor.
 ** Con varilla hexagonal y hexágono conductor.



Incluye 22 bocas

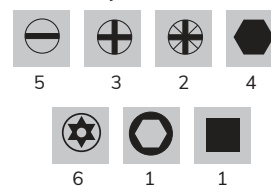

Cód.	Nº piezas	P.V.P. unid. €	
119060	22	61,47	1



DESTORNILLADOR CON CARRACA, VASOS Y PUNTIAS



CARRACA REGULABLE: A DERECHAS, A IZQUIERDAS Y BLOQUEADO



COMPOSICIÓN

- 1 Mango atornillador con carraca.
- 1 Adaptador para vasos de 1/4".
- 1 Adaptador magnético de 100 mm.
- 8 Vasos de 1/4": 6, 7, 8, 9, 10, 11, 12, 13.
- 10 Puntas de 1/4" 25 mm:
- 3 Planas 4, 5, 6 mm.
- 2 PH1, PH2.
- 3 T10, T15, T20.
- 2 PZ1, PZ2.

Cód.	Nº piezas	P.V.P. unid. €	
119115	21	29,07	1

Se suministra en blíster.

06



JUEGO ADAPTADOR MAGNÉTICO Y PUNTIAS



COMPOSICIÓN

- 1 Adaptador magnético para puntas de 1/4" (119100).
- 1 Adaptador para vasos de 1/4".
- 10 Puntas de 1/4" 25 mm:
- 3 Plana 4, 5, 6 mm.
- 3 T10, T15, T20.
- 2 PH1, PH2.
- 2 PZ1, PZ2.

Cód.	Nº piezas	P.V.P. unid. €	
119110	12	10,31	6

Se suministra en blíster.



ADAPTADOR MAGNÉTICO PARA PUNTAÑ DE 1/4"



Cód.		mm	P.V.P. unid. €	
119100	1/4"	100	7,56	12



ADAPTADOR MAGNÉTICO RÁPIDO PUNTAÑ DE 1/4"



Cód.		mm	P.V.P. unid. €	
119107	1/4"	40	8,37	12

ADAPTADOR PARA VASOS 1/4"

1/4



Cód.	mm	P.V.P. unid. €	
119105	1/4"	60	6,84 12

ADAPTADOR MAGNÉTICO FLEXIBLE PUNTAS 1/4"



Cód.	mm	P.V.P. unid. €	
119102	1/4"	190	11,14 12

DESTORNILLADOR INTERCAMBIABLE



06

Cód.	mm	+	mm	P.V.P. unid. €	
119120	6	PH2	125	6,47	12
119125	6	PH2	175	7,05	12
119130	6	PH2	63	5,81	12



JUEGO DE 20 DESTORNILLADORES EN 1 INTERCAMBIABLES



- Varilla de Acero al Cr-V-Mo con punta magnética.
- Ranuras para fijación con el mango (doble posición).

COMPOSICIÓN

- 1 Mango bicomponente.
- 10 Varillas con doble punta: 1 \ominus 3,0/ \ominus 4,0 mm.
- 1 \ominus 5,5/ \ominus 6,5 mm. 1 \bullet 3,0/ \bullet 4,0 mm. 1 \bullet 5,0/ \bullet 6,0 mm.
- 1 \oplus PH1/ \oplus PH2. 1 \oplus PZ1/ \oplus PZ2. 1 \oplus PH3/ \oplus PZ3.
- 1 \oplus T10/ \oplus T15. 1 \oplus T20/ \oplus T25. 1 \oplus T30/ \oplus T40.



Cód.	Nº piezas	P.V.P. unid. €	
119117	11	30,27	1



DESTORNILLADOR BOCA RECTA



DIN 5265 ACERO CR-V-MO  

- Varilla fabricada en Acero Cr-V.
- Varillas con punta negra magnética.
- Mango bimaterial ergonómico.



Cód.	Ø mm	mm	mm	P.V.P. unid. €	
170413	3,0	0,5	100	1,69	18
170414	4,0	0,8	100	2,01	18
170415	5,0	0,8	150	2,73	18

Se suministra con colgador.

06



DESTORNILLADOR BOCA PLANA



DIN 5265 ACERO CR-V-MO  



Cód.	Ø mm	mm	mm	P.V.P. unid. €	
170404	4,0	0,8	100	1,94	18
170405	5,5	1,0	125	2,50	18
170406	6,5	1,2	150	3,27	12
170408	8,0	1,2	150	4,02	12

Se suministra con colgador.



DESTORNILLADOR BOCA POZIDRIVE



DIN 5262 ACERO CR-V-MO  



Cód.		mm	P.V.P. unid. €	
170430	PZ0	75	2,13	18
170431	PZ1	100	2,50	18
170432	PZ2	150	3,03	12
170433	PZ3	150	4,63	12

Se suministra con colgador.



DESTORNILLADOR BOCA PHILLIPS



DIN 5262 ACERO CR-V-MO  

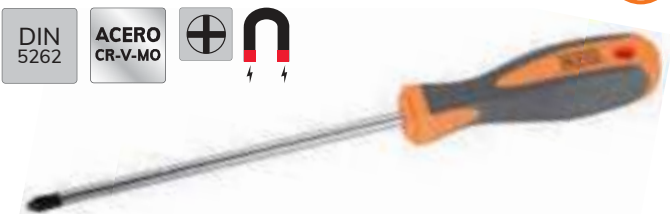

Cód.		mm	P.V.P. unid. €	
170420	PH0	75	1,79	18
170421	PH1	100	2,27	18
170419	PH2	100	2,59	18
170422	PH2	150	2,73	12
170423	PH3	150	4,31	12

Se suministra con colgador.



DESTORNILLADOR BOCA TORX



ACERO CR-V-MO  



Cód.		mm	P.V.P. unid. €	
170440	T10	100	2,68	18
170441	T15	100	2,78	18
170442	T20	100	2,73	18
170443	T25	100	3,14	18
170444	T30	100	3,34	18
170445	T40	125	3,97	18

Se suministra con colgador.

DESTORNILLADOR BOCA RECTA. SERIE LARGA



Cód.	Ø mm	mm	mm	P.V.P. unid. €	📦
170418	6,0	0,8	300	4,56	12

DESTORNILLADOR BOCA PLANA. SERIE CORTA



Cód.	Ø mm	mm	mm	P.V.P. unid. €	📦
170412	6,5	1,2	38	2,92	18

DESTORNILLADOR BOCA PHILLIPS. SERIE LARGA



Cód.	Tip	mm	P.V.P. unid. €	📦
170426	PH1	250	3,67	12
170427	PH2	300	4,56	12

DESTORNILLADOR BOCA PHILLIPS. SERIE CORTA



Cód.	Tip	mm	P.V.P. unid. €	📦
170428	PH1	38	2,11	12
170429	PH2	38	2,49	12

06

JUEGO DE DESTORNILLADORES



COMPOSICIÓN

- 2 4x100, 5x150 (Boca recta).
- 2 6.5x125, 8x150 (Boca plana).
- 2 PH1x100, PH2x150.
- 2 PZ1x100, PZ2x150.

Cód.	Nº piezas	P.V.P. unid. €	📦
170450	8	19,34	5

JUEGO DE DESTORNILLADORES



COMPOSICIÓN

- 1 3x75 (Boca recta).
- 2 4x100, 6.5x150 (Boca plana).
- 2 PH1x100, PH2x150.

Cód.	Nº piezas	P.V.P. unid. €	📦
170448	5	10,74	6

JUEGO DE DESTORNILLADORES



COMPOSICIÓN

- 1 3x100 (Boca recta).
- 1 5.5x125 (Boca plana).
- 2 PH1x100, PH2x100.

Cód.	Nº piezas	P.V.P. unid. €	📦
170449	4	8,96	6





JUEGO COMBINADO DE DESTORNILLADORES



ACERO
CR-V-MO



COMPOSICIÓN

- 7 Destornilladores:
 - 4 3x75, 5x100, 6x125, 8x150.
 - 3 PH0x75, PH1x100, PH2x125.
- 10 Destornilladores de precisión:
 - 6 T5, T6, T7, T8, T9, T10x50 mm.
 - 2 PH00x50, PH0x50 mm.
 - 2 2.5x50, 3x50 mm.
- 16 Puntas 1/4" 25 mm:
 - 4 PZ0, PZ1, PZ2, PZ3.
 - 6 2, 3, 4, 5, 6, 8 mm.
 - 6 T10, T15, T20, T25, T27, T30.
- 1 Portapuntas magnético con mango.
- 9 Vasos 1/4": 4, 5, 6, 7, 8, 9, 10, 11, 12 mm.
- 1 Adaptador vasos 1/4".



Dimensión caja: 310x70x240 mm.

06

Cód.	Nº piezas	P.V.P. unid. €	
170465	44	29,15	6



JUEGO DE DESTORNILLADORES EN SOPORTE



COMPOSICIÓN

- 8 Destornilladores:
 - 4 5x100, 6x125, 8x150, 6x38 mm.
 - 4 PH1x100, PH2x125, PH3x150, PH2x38 mm.
- 10 Destornilladores de precisión:
 - 6 T5, T6, T7, T8, T9, T10x50 mm.
 - 2 PH00x50, PH0x50 mm.
 - 2 2.5x50, 3x50 mm.

Cód.	Nº piezas	P.V.P. unid. €	
170463	18	25,80	6



Dimensión caja: 240x70x280 mm.



ADAPTADOR MAGNÉTICO PARA PUNTAS DE 1/4"



Cód.		mm	P.V.P. unid. €	
170451	1/4"	100	2,95	12

Se suministra con colgador.



Hexágono para puntas de 1/4"



JUEGO ADAPTADOR MAGNÉTICO Y PUNTAS



COMPOSICIÓN

- 8 Puntas 1/4" 25 mm:
- 2 5, 6 mm.
- 2 PH1, PH2.
- 2 PZ1, PZ2.
- 2 T15, T20.
- 1 Adaptador magnético para puntas de 1/4".



Cód.	Nº piezas	P.V.P. unid. €	
170457	9	4,86	12

Se suministra en blíster.

06



JUEGO ADAPTADOR CON MANGO, PUNTAS Y VASOS



COMPOSICIÓN

- 8 Puntas 1/4" 25mm:
- 2 4.5, 7 mm.
- 2 PH1, PH2.
- 2 PZ1, PZ2.
- 2 T15, T20.
- 5 Vasos 1/4": 7, 8, 10, 11, 13 mm.
- 1 Adaptador magnético con mango.
- 1 Adaptador vasos 1/4": 1/4" M. x 1/4" Hex.



Cód.	Nº piezas	P.V.P. unid. €	
170461	15	8,09	12

Se suministra en blíster.



DESTORNILLADOR INTERCAMBIABLE 6 EN 1



COMPOSICIÓN

- 1 Adaptador doble Hex 1/4" H x Hex 5/16"H.
- 1 5 mm / PH1.
- 1 6 mm / PH2.

Cód.	Nº piezas	P.V.P. unid. €	
170454	4	6,55	12

Se suministra en blíster.





DESTORNILLADOR DE PRECISIÓN. BOCA PHILLIPS



EMPLEO EN RELOJERÍA, ELECTRÓNICA, ORDENADORES, ELECTRODOMÉSTICOS, COMUNICACIÓN...

Cód.	+	mm	P.V.P. unid. €	
119529	PH00	50	3,50	12
119530	PH0	50	3,50	12
119531	PH1	50	3,50	12



06



DESTORNILLADOR DE PRECISIÓN. BOCA RECTA



Cód.	—	mm	P.V.P. unid. €	
119501	1,0	50	3,50	12
119515	1,5	50	3,50	12
119502	2,0	50	3,50	12
119525	2,5	50	3,50	12
119503	3,0	50	3,50	12



DESTORNILLADOR DE PRECISIÓN. BOCA TORX INVIOLEBLE



Cód.	T	mm	P.V.P. unid. €	
119535	T5	50	3,64	12
119536	T6	50	3,64	12
119537	T7	50	3,64	12
119538	T8	50	3,64	12
119539	T10	50	3,64	12
119540	T15	50	3,64	12



JUEGO DE DESTORNILLADORES DE PRECISIÓN

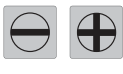

COMPOSICIÓN

3 — 1.5x50, 2.0x50, 3.0x50 mm.
3 + PH00x50, PH0x50, PH1x50 mm.

Cód.	Nº piezas	P.V.P. unid. €	
193465	6	20,53	1





JUEGO DE 30 DESTORNILLADORES DE PRECISIÓN EN 1



30 PUNTAS EN 1

COMPOSICIÓN

- 1 Mango de destornillador de precisión.
- 1 Adaptador magnético para puntas 110 mm.
- 30 Puntas 1/4" 25 mm:
- 7 1.0, 1.5, 2.0, 2.5, 3.0, 3.5, 4.0.
- 4 PH000, PH00, PH0, PH1.
- 2 PZ0, PZ1.
- 8 0.7, 0.9, 1.3, 1.5, 2.0, 2.5, 3.0, 4.0.
- 9 T4, T5, T6, T7, T8, T9, T10, T15, T20.



Alargadera con 3 hendiduras



Cód.	Nº piezas	P.V.P. unid. €	
193467	32	25,09	1



JUEGO DE DESTORNILLADORES DE PRECISIÓN



06

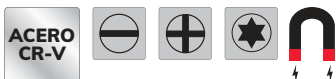

COMPOSICIÓN

- 2 PH00x50 mm, PH0x50 mm.
- 2 2.5x50, 3x50 mm.
- 3 T8x50, T9x50, T10x50 mm



Medida caja: 220x120x30mm.

Cód.	Nº piezas	P.V.P. unid. €	
170452	7	12,68	6

Se suministra en blíster.



JUEGO DE REPARACIÓN ELECTRÓNICA



Puntas especiales

COMPOSICIÓN

- 1 Portapuntas de aluminio.
- 2 Desmontadores.
- 1 Ventosa triangular.
- 1 Alargadera 4x75 mm.
- 1 Pinza.
- 1 Abridor bandeja SIM.
- 25 Puntas de precisión:
- 4 PH000, PH00, PH0, PH1.
- 4 0.8(2), 1.2, 1.5.
- 1 3.0.
- 8 T2, T3, T4, T5, T6, T7, T8, T10.
- 2 1.5, 2 mm.
- 2 1, 2 mm.
- 1 T7.
- 3 Y000, Y00, Y0.



VÁLIDO PARA REPARACIÓN DEL 98% DE LOS MÓVILES

Cód.	Nº piezas	P.V.P. unid. €	
171250	32	19,64	6



JUEGO DE REPARACIÓN ELECTRÓNICA



Puntas especiales

COMPOSICIÓN

- 1 Portapuntas de aluminio.
- 2 Desmontadores.
- 1 Ventosa.
- 1 Desmontador tarjetas SIM.
- 12 Puntas 1/4":
- 2 PH000, PH00.
- 6 T4, T5, T6, T7, T8, T10.
- 1 1.2 mm.
- 2 0.8, 2.
- 1 Y000.



VÁLIDO PARA REPARACIÓN DEL 60% DE LOS MÓVILES

Cód.	Nº piezas	P.V.P. unid. €	
171240	17	11,29	6



DESTORNILLADOR BOCA PLANA AISLADO

CERTIFICADO VDE

DIN 5265 ACERO CR-V-MO D'E GS 1000V

VARILLA REBAJADA

Marcado indeleble de homologación de la norma EN 60900



Punta magnética negra

Mango ergonómico bimaterral.

Cód.	mm	mm	mm	P.V.P. unid. €	
119302	2,5*	0,4	80	3,66	12
119303	3,0*	0,5	100	3,89	12
119304	4,0	0,8	100	4,80	12
119305	5,5	1,0	125	6,37	12
119306	6,5	1,2	150	8,04	12
119308	8,0	1,2	150	10,56	12

NORMA EN 60900:
Herramientas aisladas utilizadas para trabajos en tensiones de hasta 1000V en Corriente Alterna ó 1500V en Corriente Continua.

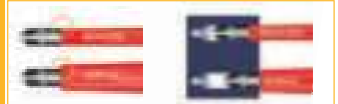

Mejor acceso en espacios reducidos.

*Medida sin varilla rebajada.

06



DESTORNILLADOR BOCA PHILLIPS AISLADO

CERTIFICADO VDE

DIN 5262 ACERO CR-V-MO D'E GS 1000V

VARILLA REBAJADA



Cód.	mm	P.V.P. unid. €	
119310	PH0*	75	4,24 12
119311	PH1	100	5,26 12
119312	PH2	100	6,37 12

*Medida sin varilla rebajada.



DESTORNILLADOR BOCA POZIDRIVE AISLADO

CERTIFICADO VDE

DIN 5262 ACERO CR-V-MO D'E GS 1000V

VARILLA REBAJADA



Cód.	mm	P.V.P. unid. €	
119321	PZ1	100	5,86 12
119322	PZ2	100	7,09 12



DESTORNILLADOR CON VASO HEXAGONAL AISLADO

CERTIFICADO VDE

ACERO CR-V D'E GS 1000V



Cód.	mm	P.V.P. unid. €	
119345	5	125	8,10 10
119344	5,5	125	8,10 10
119346	6	125	8,26 10
119347	7	125	8,44 10
119348	8	125	8,67 10

Cód.	mm	P.V.P. unid. €	
119349	9	125	8,77 10
119350	10	125	8,93 10
119351	11	125	9,72 10
119352	12	125	9,72 10
119353	13	125	10,19 10



JUEGO DE DESTORNILLADORES AISLADOS, CAJA DE CARTÓN

CERTIFICADO VDE



VARILLA REBAJADA

COMPOSICIÓN

- 4 \ominus 2.5x80*, 4x100, 5.5x125, 6.5x150 mm.
- 3 \oplus PH0x75, PH1x100, PH2x100 mm.
- 1 \ominus Tester 3x140 mm.
- * Varilla sin rebajar.

Cód.	Nº piezas	P.V.P. unid. €	
119341	8	36,73	1



JUEGO DE DESTORNILLADORES AISLADOS, BANDEJA DE PLÁSTICO

CERTIFICADO VDE

06



VARILLA REBAJADA

COMPOSICIÓN

- 3 \ominus 3x100*, 4x100, 5.5x100 mm.
- 2 \oplus PH1x100, PH2x100 mm.
- 2 \oplus PZ1x100, PZ2x100 mm.
- 1 \ominus Tester 3x140 mm.
- * Varilla sin rebajar.

Cód.	Nº piezas	P.V.P. unid. €	
119335	8	41,59	1



Medida caja: 255x185x48 mm.



JUEGO DE DESTORNILLADORES AISLADOS, CAJA DE CARTÓN

CERTIFICADO VDE



VARILLA REBAJADA

COMPOSICIÓN

- 4 \ominus 3x100*, 4x100, 5.5x125, 6.5x150 mm.
- 2 \oplus PH1x100, PH2x100 mm.
- * Varilla sin rebajar.

Cód.	Nº piezas	P.V.P. unid. €	
119330	6	35,29	1



JUEGO DE DESTORNILLADORES AISLADOS, BLISTER

CERTIFICADO VDE



VARILLA REBAJADA

COMPOSICIÓN

- 4 \ominus 3x100*, 4x100, 5.5x125, 6.5x150 mm.
- 2 \oplus PH1x100, PH2x100 mm.
- * Varilla sin rebajar.

Cód.	Nº piezas	P.V.P. unid. €	
119331	6	33,80	1





DESTORNILLADOR BOCA RECTA AISLADO



CERTIFICADO VDE

- Varilla fabricada en Acero Cr-V.
- Varilla con punta negra magnética.
- Mango bimaterial ergonómico.



NORMA EN 60900:
Herramientas aisladas utilizadas para trabajos en tensiones de hasta 1000V en Corriente Alterna ó 1500V en Corriente Continua.

Cód.	∅ mm	mm	mm	P.V.P. unid. €	📦
170383	3,0	0,5	100	2,73	12
170384	4,0	0,8	100	3,18	12
170385	5,5	1,0	125	3,41	12
170386	6,5	1,2	150	4,26	12

Se suministra con colgador.

06



DESTORNILLADOR BOCA PHILLIPS AISLADO



Cód.	+	mm	P.V.P. unid. €	📦
170390	PH0	60	2,70	12
170391	PH1	80	3,42	12
170392	PH2	100	4,20	12



DESTORNILLADOR BOCA POZIDRIVE AISLADO



Cód.	+	mm	P.V.P. unid. €	📦
170395	PZ0	60	2,70	12
170396	PZ1	80	3,42	12
170397	PZ2	100	4,20	12



JUEGO DE DESTORNILLADORES AISLADOS



CERTIFICADO VDE

COMPOSICIÓN

- 3 ⊖ 3x100, 4x100, 6.5x150 (Boca recta).
- 2 ⊕ PH1x80, PH2x100.
- 1 ⊖ Tester 3x140 mm.

Cód.	Nº piezas	P.V.P. unid. €	📦
170446	6	19,78	6





DESTORNILLADOR DE PRECISIÓN BOCA PHILLIPS AISLADO



Agujero para colgar.

CERTIFICADO VDE

Punta negra. Mayor precisión y protección contra la corrosión.



Forma ergonómica del mango. Diámetro interior muy reducido para mayor precisión.

NORMA EN 60900:
Herramientas aisladas utilizadas para trabajos en tensiones de hasta 1000V en Corriente Alterna ó 1500V en Corriente Continua.

Cód.	+	mm	P.V.P. unid. €	
119365	PH00	50	4,08	12
119366	PH0	50	4,08	12
119367	PH1	50	4,08	12



DESTORNILLADOR DE PRECISIÓN BOCA RECTA AISLADO



CERTIFICADO VDE



Cód.	mm	mm	P.V.P. unid. €	
119361	1,5	50	4,08	12
119362	2,0	50	4,08	12
119363	2,5	50	4,08	12
119364	3,0	50	4,08	12



DESTORNILLADOR DE PRECISIÓN BOCA TORX AISLADO



CERTIFICADO VDE



Cód.		mm	P.V.P. unid. €	
119368	T5	50	4,08	12
119369	T6	50	4,08	12
119370	T7	50	4,08	12
119371	T8	50	4,08	12
119372	T10	50	4,08	12
119373	T15	50	4,08	12



JUEGO DE DESTORNILLADORES DE PRECISIÓN AISLADOS

CERTIFICADO VDE



COMPOSICIÓN

- 3 1,5x50, 2,0x50, 3,0x50 mm.
- 3 PH00x50, PH0x50, PH1x50 mm.

Cód.	Nº piezas	P.V.P. unid. €	
119375	6	23,61	1





JUEGO DE DESTORNILLADORES INTERCAMBIABLES AISLADOS

CERTIFICADO **VDE**



COMPOSICIÓN

VARILLA REBAJADA

- 4 \ominus 3x75*, 4x100, 5.5x125, 6.5x150 mm.
- 3 \oplus PH0x75*, PH1x100, PH2x100 mm.
- 2 \oplus PZ1x100, PZ2x100 mm.
- 1 \ominus Tester 3x140 mm.
- 1 Mango destornillador aislado.
- * Varilla sin rebajar.



06

Cód.	Nº piezas	P.V.P. unid. €	
119332	11	43,26	3



POLÍMETRO



- Gran pantalla LCD.
- Ruleta giratoria para una fácil selección.
- Diseño ergonómico.

INCLUYE:



2 x AA

FUNCIONES:

- Voltaje.
- Intensidad.
- Resistencia.
- Diodo.
- Continuidad.



Cód.	P.V.P. unid. €	
119339	32,35	1

Se suministra en caja de cartón.



TESTER 8 EN 1



L: 190 mm

VOLTAJE TESTABLE		6, 12, 24, 50, 110, 220 y 380 V		6 V
-------------------------	--	---------------------------------	--	-----

Cód.	P.V.P. unid. €	
119338	28,44	1

Se suministra en blíster.



TESTER 3 EN 1



L: 190 mm

VOLTAJE TESTABLE		110, 220 y 380 V		150, 380 y 500 V
-------------------------	--	------------------	--	------------------

Cód.	P.V.P. unid. €	
119336	11,86	1

Se suministra en blíster.



TESTER



VOLTAJE TESTABLE 100-250V.

Cód.			P.V.P. unid. €	
	mm	mm		
193369	3,0	140	2,91	24



07

LLAVES DE VASO

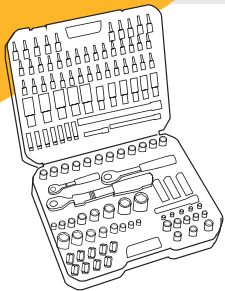

Juegos de vasos combinados **190**

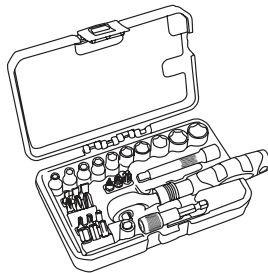

Vaso de 1/4" **193**

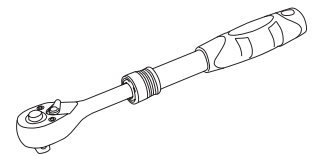

Vaso de 3/8" **201**

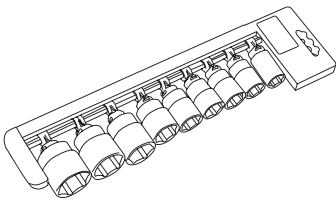

Vaso de 1/2" **208**

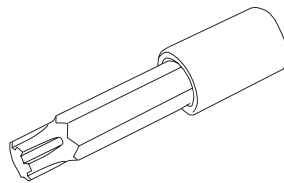

Vaso de automoción **212**

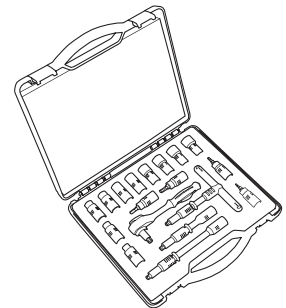

Vaso aislado **213**

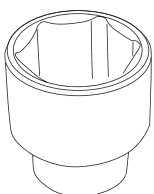

Vaso de 3/4" **216**

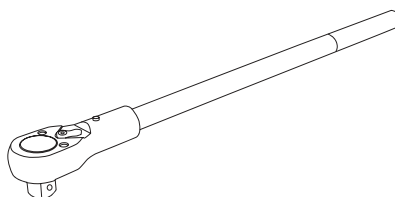

Vaso de 1" **217**

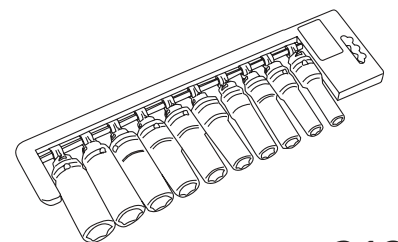

Vaso de impacto **218**



JUEGO DE LLAVES DE VASO DE 1/2" + 3/8" + 1/4"

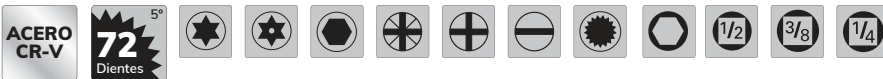

COMPOSICIÓN 1/2"

- 17 Vasos 10 a 32 mm
- 5 Vasos largos 14, 15, 17, 19, 22 mm
- 3 Vasos torx hembra E20, E22, E24
- 1 Junta universal
- 2 Llaves buija 16, 21 mm
- 1 Carraca extensible
- 1 Adaptador puntas 5/16"
- 2 Alargaderas 125, 250 mm

COMPOSICIÓN 3/8"

- 10 Vasos 10 a 19 mm
- 6 Vasos largos 10, 11, 12, 13, 14, 15 mm
- 5 Vasos torx hembra E10, E12, E14, E16, E18
- 1 Junta universal
- 1 Llaves buija 16 mm
- 1 Carraca extensible
- 1 Adaptador puntas 1/4"
- 2 Alargaderas 75, 150 mm
- 10 Vasos con puntas: 5 3, 4, 5, 6, 7, 8, 9, 10 mm; 5 T45, T47, T50, T55, T60

COMPOSICIÓN 1/4"

- 13 Vasos 4 a 14 mm
- 7 Vasos largos 4, 5, 6, 7, 8, 9, 10 mm
- 5 Vasos torx hembra E4, E5, E6, E7, E8
- 30 Vasos con puntas: 5 3, 4, 5, 6, 7 mm; 8 3, 4, 4.5, 5, 5.5, 6, 6.5, 7 mm; 4 PH0, PH1, PH2, PH3; 4 PZ0, PZ1, PZ2, PZ3; 9 T8, T9, T10, T15, T20, T25, T27, T30, T40
- 21 Puntas 5/16": 7 4, 5, 6, 7, 8, 10, 12 mm; 2 PH2, PH3; 7 T20, T25, T30, T40, T45, T50, T55; 5 M5, M6, M8, M10, M12
- 5 Llaves allen 1.25, 1.5, 2, 2.5, 3 mm
- 1 Junta universal
- 2 Alargaderas 50, 100 mm
- 1 Carraca
- 1 Atornillador 150 mm

Cód.	Nº piezas	P.V.P. unid. €	
192386	155	304,07	2

CAJA CON CIERRES Y BISAGRAS METÁLICAS



Dimensión caja: 440x370x110 mm.

Carracas extensibles 1/2" y 3/8"



JUEGO DE LLAVES DE VASO DE 1/2" + 1/4"



COMPOSICIÓN 1/2"

- 13 Vasos 10 a 15, 17, 19, 22, 24, 27, 30, 32 mm
- 1 Carraca extensible
- 2 Alargaderas 125, 250 mm
- 1 Adaptador puntas 5/16"
- 1 Adaptador puntas 3/8"H x 1/2"M
- 1 Adaptador vasos 1/2"

COMPOSICIÓN 1/4"

- 12 Vasos 4, 4.5, 5, 5.5, 6, 7, 8, 9, 10, 11, 12, 13
- 1 Carraca extensible
- 12 Vasos con puntas: 2 4, 5, 5 mm; 2 PH1, PH2; 5 T15, T20, T25, T27, T30; 3 4, 5, 6 mm
- 12 Puntas 5/16": 2 7, 8 mm; 2 PH3, PH4; 5 T40, T45, T50, T55, T60; 3 8, 10, 12 mm
- 5 Llaves allen 1.25, 1.5, 2, 2.5, 3 mm
- 2 Alargaderas 50, 100 mm
- 1 Adaptador puntas 5/16"
- 1 Adaptador puntas 3/8"H x 1/4"M
- 1 Adaptador vasos 1/4"

Cód.	Nº piezas	P.V.P. unid. €	
192389	66	151,07	1

CAJA CON CIERRES Y BISAGRAS METÁLICAS



Dimensión caja: 305x240x85 mm.

Carracas extensibles 1/4" y 1/2"



JUEGO DE LLAVES DE VASO DE 1/2" + 3/8" + 1/4"



ACERO CR-V

72 Dientes

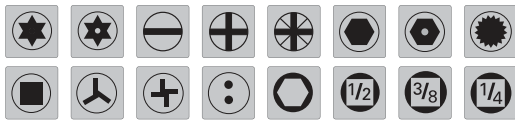

INCLUYE 14 VASOS TORX HEMBRA

COMPOSICIÓN 1/2"

15 Vasos 10 a 32 mm	5 Vasos largos 16, 17, 18, 19, 22 mm	4 Vasos Torx hembra E18, E20, E22, E24	2 Llaves bujía 16, 21 mm
1 Adapt. puntas 5/16"	1 Carraca	2 Alargaderas 125, 250 mm	1 Adaptador 1/2" M x 3/8" H
2 Vasos con punta T55, T60	1 Junta universal		

COMPOSICIÓN 3/8"

10 Vasos 10 a 19 mm	6 Vasos largos 10 a 15 mm	5 Vasos Torx hembra E8 a E16	1 Llaves bujía 18 mm
1 Alargadera 125 mm	1 Junta universal	1 Adaptador puntas 5/16"	1 Carraca

COMPOSICIÓN 1/4"

13 Vasos 4 a 14 mm	7 Vasos largos 4 a 10 mm	5 Vasos Torx hembra E4 a E8	2 Alargaderas 50, 100 mm
1 Adapt. puntas 1/4"	1 Carraca	1 Junta universal	1 Mango en "T" 115 mm
1 Atornillador 150 mm	30 Vasos con puntas	44 Puntas de atornillar	

10 Llaves allen 1.27 a 5 mm	1 Mango portapuntas 150 mm	12 Llaves combinadas 8 a 19 mm	30 Puntas 5/16"
-----------------------------	----------------------------	--------------------------------	-----------------

Cód.	Nº piezas	P.V.P. unid. €	
192404	219	230,24	2

CAJA CON CIERRES Y BISAGRAS METÁLICAS



Dimensión caja: 460x340x90 mm.

07



JUEGO DE LLAVES DE VASO DE 1/2" + 3/8" + 1/4"



ACERO CR-V

72 Dientes



INCLUYE 13 VASOS TORX HEMBRA

COMPOSICIÓN 1/2"

17 Vasos 10 a 32 mm	5 Vasos largos 16, 17, 18, 19, 22 mm	2 Vasos Torx hembra E20, E24	2 Llaves bujía 16, 21 mm
1 Adapt. puntas 3/8"	1 Carraca	2 Alargaderas 125, 250 mm	1 Adaptador 1/2" M x 3/8" H
1 Junta universal			

COMPOSICIÓN 3/8"

10 Vasos 10 a 19 mm	6 Vasos largos 10 a 15 mm	5 Vasos Torx hembra E10 a E18	1 Llaves bujía 18 mm
1 Adapt. puntas 5/16"	1 Carraca	1 Alargadera 150 mm	1 Junta universal

COMPOSICIÓN 1/4"

13 Vasos 4 a 14 mm	7 Vasos largos 4, 5, 6, 7, 8, 9, 10 mm	5 Vasos Torx hembra E4 a E8	1 Adaptador puntas 1/4"
1 Carraca	2 Alargaderas 50, 100 mm	1 Junta universal	1 Mango en "T" 115 mm
1 Atornillador 150 mm	30 Vasos con puntas	20 Puntas 1/4"	

7 Llaves allen 1.27 a 5 mm	18 Puntas 5/16"	6 Puntas 3/8"
----------------------------	-----------------	---------------

Cód.	Nº piezas	P.V.P. unid. €	
170745	171	184,75	2

CAJA CON CIERRES Y BISAGRAS METÁLICAS



Dimensión caja: 460x340x90 mm.



JUEGO DE LLAVES DE VASO DE 1/2" + 1/4"



ACERO CR-V 72^{5º} Dientes

COMPOSICIÓN 1/2"

- | | | |
|---------------------------|--------------------------------------|-------------------------------|
| 17 Vasos 10 a 32 mm | 5 Vasos largos 14, 15, 17, 19, 22 mm | 1 Carraca |
| 2 Alargaderas 125, 250 mm | 1 Junta universal | 1 Adaptador 1/2" M x 3/8" H |
| 1 Adaptador puntas 5/16" | 2 Llaves bujía 16, 21 mm | 8 Vasos Torx hembra E10 a E24 |

COMPOSICIÓN 1/4"

- | | | |
|-----------------------------|-----------------------------------|-----------------------|
| 13 Vasos 4 a 14 mm | 8 Vasos largos 6 a 13 mm | 1 Carraca |
| 2 Alargaderas 50, 100 mm | 1 Atornillador 150 mm | 1 Mango en "T" 100 mm |
| 1 Junta universal | 1 Adaptador vasos 1/4" M x 1/4" M | 18 Vasos con puntas |
| 5 Vasos torx hembra E4 a E8 | | |

- | | |
|--------------------------------------|-----------------|
| 4 Llaves allen 1.27, 1.5, 2, 2.25 mm | 17 Puntas 5/16" |
|--------------------------------------|-----------------|



INCLUYE 13 VASOS TORX HEMBRA



CAJA CON CIERRES Y BISAGRAS METÁLICAS

Dimensión caja: 370x275x85 mm.

Cód.	Nº piezas	P.V.P. unid. €	
192393	110	103,60	4



JUEGO DE LLAVES DE VASO DE 1/2" + 1/4"



ACERO CR-V 72^{5º} Dientes

COMPOSICIÓN 1/2"

- | | | |
|---------------------------|----------------------------------|-----------------------------|
| 18 Vasos 10 a 32 mm | 4 Vasos largos 14, 15, 17, 19 mm | 1 Carraca |
| 2 Alargaderas 125, 250 mm | 1 Junta universal | 1 Adaptador 1/2" M x 3/8" H |
| 1 Adaptador puntas 5/16" | 2 Llaves bujía 16, 21 mm | |

COMPOSICIÓN 1/4"

- | | | |
|--------------------------|------------------------------|--------------------------------|
| 13 Vasos 4 a 14 mm | 8 Vasos largos 6 a 13 mm | 1 Carraca |
| 2 Alargaderas 50, 100 mm | 1 Alargadera flexible 150 mm | 1 Atornillador 150 mm |
| 1 Mango en "T" 100 mm | 1 Junta universal | 1 Adapt. vasos 1/4" M x 1/4" M |
| 17 Vasos con puntas | | |

- | | |
|-------------------------------|-----------------|
| 3 Llaves allen 1.5, 2, 2.5 mm | 15 Puntas 5/16" |
|-------------------------------|-----------------|



CAJA CON CIERRES Y BISAGRAS METÁLICAS

Dimensión caja: 370x275x85 mm.

Cód.	Nº piezas	P.V.P. unid. €	
192392	94	99,97	4



JUEGO DE LLAVES DE VASO DE 1/4"



COMPOSICIÓN

- | | | |
|---|--|-------------------------------------|
| 1 Carraca extensible | 1 Alargadera flexible 150 mm | 1 Adapt. vasos 1/4" |
| 13 Vasos 4 a 14 mm | 2 Alargaderas 50, 150 mm | 1 Atornillador 150 mm |
| 6 Vasos largos 6, 7, 8, 10, 12, 13 mm | 1 Junta universal | 4 Llaves allen 1.25, 1.5, 2, 2.5 mm |
| 5 Vasos torx hembra E4, E5, E6, E7, E8 | 1 Adaptador 1/4" M x 3/8" H | 1 Adap. Puntas 1/4" |
| 21 Vasos con puntas:
6 Ⓞ 3, 4, 5, 6, 7, 8 mm
3 Ⓞ 4, 5.5, 7 mm | 3 Ⓞ PH1, PH2, PH3
3 Ⓞ PZ1, PZ2, PZ3 | 6 Ⓞ T10, T15, T20, T25, T30, T40 |



Carraca extensible

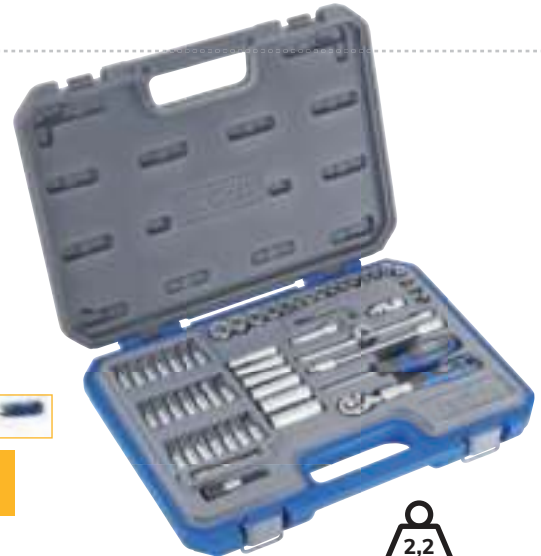

CAJA CON CIERRES Y BISAGRAS METÁLICAS

Dimensión caja: 365x240x85 mm.

Cód.	Nº piezas	P.V.P. unid. €	
192187	58	85,60	1

07



JUEGO DE LLAVES DE VASO DE 1/4" - PULGADAS



COMPOSICIÓN

- | | | |
|---|--|-------------------------------------|
| 1 Carraca extensible | 1 Alargadera flexible 150 mm | 1 Adapt. Puntas 1/4" |
| 11 Vasos: 5/32", 3/16", 7/32", 1/4", 9/32", 5/16", 11/32", 3/8", 7/16", 1/2", 9/16" | 2 Alargaderas 50, 150 mm | 1 Adapt. vasos 1/4" |
| 6 Vasos largos 1/4", 9/32", 5/16", 3/8", 7/16", 1/2" | 1 Junta universal | 1 Atornillador 150 mm |
| 5 Vasos torx hembra E4, E5, E6, E7, E8 | 1 Adaptador 3/8" H x 1/4" M | 4 Llaves allen 1.25, 1.5, 2, 2.5 mm |
| 21 Vasos con puntas:
6 Ⓞ 3, 4, 5, 6, 7, 8 mm
3 Ⓞ 4, 5.5, 7 mm | 3 Ⓞ PH1, PH2, PH3
3 Ⓞ PZ1, PZ2, PZ3 | 6 Ⓞ T10, T15, T20, T25, T30, T40 |



Carraca extensible



CAJA CON CIERRES Y BISAGRAS METÁLICAS

Dimensión caja: 365x240x85 mm.

Cód.	Nº piezas	P.V.P. unid. €	
190295	56	87,79	1



JUEGO DE LLAVES DE VASO DE 1/4"



COMPOSICIÓN

- | | | |
|--|--|----------------------|
| 1 Carraca extensible | 1 Adaptador puntas 1/4" | 1 Adapt. Puntas 1/4" |
| 10 Vasos 4 a 13 mm | 1 Alargadera 75 mm | |
| 15 Vasos con puntas:
3 Ⓞ 5, 6, 8 mm
3 Ⓞ 4, 5.5, 6.5 mm | 3 Ⓞ PH1, PH2, PH3
3 Ⓞ PZ1, PZ2, PZ3 | 3 Ⓞ T15, T20, T25 |



Muy compacto



Carraca extensible



Dimensión caja: 160x110x40 mm.

Cód.	Nº piezas	P.V.P. unid. €	
192195	29	52,40	6



JUEGO DE LLAVES DE VASO DE 1/4" - PASANTES



COMPOSICIÓN 1/4" PASANTE

- 8 Vasos pasantes 10 a 19 mm
- 1 Carraca pasante 1/4"
- 1 Alargadera pasante 75 mm
- 1 Adaptador para carraca pasante para vasos de 1/4"



COMPOSICIÓN 1/4" NORMAL

- 13 Vasos 4 a 14 mm
- 1 Alargadera 50 mm
- 1 Adaptador puntas 1/4"
- 1 Atornillador con carraca y cabeza flexible
- 20 Puntas
 - 4 Ⓞ 3, 4, 5, 6 mm
 - 3 ⊕ PH1, PH2, PH3
 - 7 ⊕ T8, T10, T15, T20, T25, T27, T30
 - 3 ⊖ 4, 5.5, 7 mm
 - 3 ⊕ PZ1, PZ2, PZ3



Dimensión caja: 335x175x50 mm.

Cód.	Nº piezas	P.V.P. unid. €	
192182	47	84,39	5

07



JUEGO DE LLAVES DE VASO DE 1/4"



COMPOSICIÓN

- 13 Vasos 4 a 14 mm
- 1 Carraca
- 1 Adapt. vasos 1/4" 1/4" M. x 1/4" M.
- 1 Atornillador 150 mm
- 1 Mango en "T" 100 mm
- 1 Alargadera flexible 150 mm
- 2 Alargaderas 50, 100 mm
- 4 Llaves allen 1,27, 1,5, 2, 2,5 mm
- 21 Vasos con puntas Ⓞ ⊕ ⊖ ⊕
- 1 Junta universal



Dimensión caja: 225x150x50 mm.

Cód.	Nº piezas	P.V.P. unid. €	
192394	46	42,87	5

CAJA CON CIERRE Y BISAGRA METÁLICA



JUEGO DE LLAVES DE VASO DE 1/4"



COMPOSICIÓN

- 1 Carraca
- 12 Vasos 4, 4.5, 5, 5.5, 6, 7, 8, 9, 10, 11, 12, 13 mm
- 1 Alargadera 50 mm
- 1 Adaptador para puntas 1/4"
- 4 Llaves allen 1,27, 1,5, 2, 2,5 mm
- 1 Atornillador 150 mm
- 14 Puntas 1/4" Ⓞ ⊕ ⊖ ⊕
- 1 Junta universal



Dimensión caja: 200x120x45 mm.

Cód.	Nº piezas	P.V.P. unid. €	
170735	35	33,46	5



JUEGO DE LLAVES DE VASO DE 1/4"

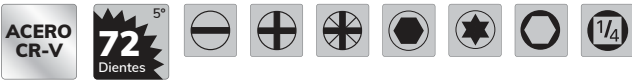

COMPOSICIÓN

1 Carraca	10 Vasos 4, 4.5, 5, 5.5, 6, 7, 8, 10, 12, 13 mm	1 Alargadera 50 mm
1 Adaptador para puntas 1/4"	1 Adapt. puntas 1/4"	1 Adapt. vasos 1/4" 1/4" M. x 1/4" M. Hex
16 Puntas 1/4"		

Cód.	Nº piezas	P.V.P. unid. €	
192401	31	28,46	5



Dimensión caja: 155x98x36 mm.



LLAVE DE CARRACA DE 1/4" CON MANGO EXTENSIBLE



- Con expulsor de vasos y reversor.
- Longitud ajustable a 6 medidas entre 150 y 200 mm.



Cód.	L mín. / L máx. mm	P.V.P. unid. €	
192139	150/200	28,19	5

Se suministra con colgador.



LLAVE DE CARRACA DE 1/4"



- Con expulsor de vasos y reversor.



Cód.	L mm	P.V.P. unid. €	
192138	153	21,43	5

Se suministra con colgador.



LLAVE DE CARRACA CORTA DE 1/4"



- Con expulsor de vasos y reversor.



Cód.	L mm	P.V.P. unid. €	
192136	112	17,75	5

Se suministra con colgador.



LLAVE DE CARRACA DUAL DE 1/4"



- Con reversor.

- 1 Para utilizar con vasos de 1/4".
- 2 Para utilizar con puntas de 1/4".



Cód.	L mm	P.V.P. unid. €	
192133	112	18,86	5

Se suministra con colgador.



07



LLAVE DE CARRACA DE 1/4"



DIN 3122 ACERO CR-V 72 Dientes 5° 1/4

- Mecanismo reversioner mediante palanca.
- Mecanismo de retención y expulsión de vasos por botón.



Cód.	L mm	P.V.P. unid. €	
170715	150	14,95	5

Se suministra con colgador.

07



LLAVE DE CARRACA DE 1/4" CORTA



DIN 3122 ACERO CR-V 72 Dientes 5° 1/4



Cód.	L mm	P.V.P. unid. €	
170718	105	16,08	5

Se suministra con colgador.



LLAVE DE CARRACA DE 1/4" DUAL



DIN 3122 ACERO CR-V 72 Dientes 5° 1/4

- 1 Para utilizar con vasos de 1/4".
- 2 Para utilizar con puntas de 1/4".



Para vasos y puntas

Cód.	L mm	P.V.P. unid. €	
170712	100	11,07	5

Se suministra con colgador.



JUEGO DE LLAVES DE VASO DE 1/4"



ACERO CR-V 72 Dientes 5° 1/4

COMPOSICIÓN

- 10 Vasos 4, 5, 6, 7, 8, 9, 10, 11, 12 y 13 mm
- 1 Carraca
- 1 Alargadera 100 mm

Cód.	Nº piezas	P.V.P. unid. €	
170751	12	21,10	5

Se suministra en blíster.



LLAVE DE VASO DE 1/4"



■ Terminación cromado mate.



Cód.	mm	L mm	D1 mm	D2 mm	P.V.P. unid. €	
192101	4	25	6,8	11,9	2,08	10
192102	4,5	25	7,1	11,9	2,08	10
192103	5	25	8,0	11,9	2,08	10
192104	5,5	25	8,3	11,9	2,08	10
192105	6	25	9,3	11,9	2,08	10
192106	7	25	10,5	11,9	2,08	10
192107	8	25	11,9	11,9	2,08	10
192108	9	25	12,9	12,9	2,08	10
192109	10	25	13,9	13,9	2,24	10
192110	11	25	15,8	15,8	2,24	10
192111	12	25	16,8	16,8	2,36	10
192112	13	25	17,8	17,8	3,08	10
192113	14	25	17,5	17,8	3,25	10

LLAVE DE VASO DE 1/4" - PULGADAS



■ Terminación cromado mate.



Cód.	"	L mm	D1 mm	D2 mm	P.V.P. unid. €	
190250	5/32"	21	6,9	11,9	2,08	1
190252	3/16"	21	7,5	11,9	2,08	1
190254	7/32"	21	8,1	11,9	2,08	1
190256	1/4"	21	9,9	11,9	2,08	1
190258	9/32"	21	11,9	11,9	2,08	1
190260	5/16"	21	11,9	11,9	2,08	1
190262	11/32"	21	12,9	12,9	2,08	1
190264	3/8"	21	13,9	13,9	2,24	1
190266	7/16"	21	16,2	16,2	2,24	1
190268	1/2"	21	18,9	18,9	2,28	1
190270	9/16"	21	19,9	19,9	3,08	1

07

LLAVE DE VASO DE 1/4", SERIE LARGA



■ Terminación cromado mate.



Cód.	mm	L mm	D1 mm	D2 mm	P.V.P. unid. €	
192120	6	50	9,3	11,9	4,09	10
192121	7	50	10,5	11,9	4,09	10
192122	8	50	11,9	11,9	4,09	10
192124	10	50	14,5	14,5	4,09	10
192126	12	50	16,8	16,8	4,34	10
192127	13	50	17,8	17,8	4,67	10

LLAVE DE VASO DE 1/4", SERIE LARGA - PULGADAS



■ Terminación cromado mate.



Cód.	"	L mm	D1 mm	D2 mm	P.V.P. unid. €	
190280	1/4"	50	10,3	11,9	4,09	1
190282	9/32"	50	10,6	11,9	4,09	1
190284	5/16"	50	11,9	11,9	4,09	1
190286	3/8"	50	14,7	14,7	4,09	1
190288	7/16"	50	16,5	16,5	4,34	1
190290	1/2"	50	17,9	17,9	4,67	1

LLAVE DE VASO DE 1/4" TORX HEMBRA (TIPO E)



■ Terminación cromado mate.

Cód.		L mm	P.V.P. unid. €	
192114	E4	27	2,63	10
192115	E5	27	2,63	10
192116	E6	27	2,63	10

Cód.		L mm	P.V.P. unid. €	
192117	E7	27	2,63	10
192118	E8	27	2,63	10

LLAVE DE VASO DE 1/4" CON PUNTA PLANA



■ Longitud: 37mm

Cód.	∅ mm	∅ mm	P.V.P. unid. €	
192014	4,0	0,8	3,38	10
192015	5,5	1,0	3,38	10
192016	6,5	1,2	3,38	10
192018	8,0	1,2	3,38	10

LLAVE DE VASO DE 1/4" CON PUNTA HEXAGONAL



■ Longitud: 37mm

Cód.	∅ mm	P.V.P. unid. €	
192003	3	3,38	10
192004	4	3,38	10
192005	5	3,38	10
192006	6	3,38	10
192008	8	3,38	10

LLAVE DE VASO DE 1/4" CON PUNTA PHILLIPS



■ Longitud: 37mm

Cód.		P.V.P. unid. €	
192021	PH1	3,38	10
192022	PH2	3,38	10
192023	PH3	3,38	10

LLAVE DE VASO DE 1/4" CON PUNTA POZIDRIVE



■ Longitud: 37mm

Cód.		P.V.P. unid. €	
192031	PZ1	3,38	10
192032	PZ2	3,38	10
192033	PZ3	3,38	10

LLAVE DE VASO DE 1/4" CON PUNTA TORX



■ Longitud: 37mm

Cód.		P.V.P. unid. €	
192040	T6	3,72	10
192041	T7	3,72	10
192042	T8	3,72	10
192043	T9	3,72	10
192044	T10	3,72	10
192045	T15	3,72	10
192046	T20	3,72	10
192047	T25	3,72	10
192039	T27	3,72	10
192048	T30	3,72	10
192049	T40	3,72	10

LLAVE DE VASO DE 1/4" CON PUNTA TORX INVIOLEBLE



■ Longitud: 37mm

Cód.		P.V.P. unid. €	
192051	T6	4,88	10
192052	T7	4,88	10
192053	T8	4,88	10
192054	T9	4,88	10
192055	T10	4,88	10
192056	T15	4,88	10
192057	T20	4,88	10
192058	T25	4,88	10
192059	T30	4,88	10
192060	T40	4,88	10

LLAVE DE VASO DE 1/4" CON PUNTA XZN



■ Longitud: 37mm

Cód.		P.V.P. unid. €	
192064	M4	3,38	10
192065	M5	3,38	10
192066	M6	3,38	10
192068	M8	3,38	10

JUEGO DE LLAVES DE VASO DE 1/4" EN REGLETA



COMPOSICIÓN

4, 4.5, 5, 5.5, 6, 7, 8, 9, 10, 11, 12, 13, 14 mm

Cód.	Nº Piezas	P.V.P. unid. €	
192119	13	23,34	1

JUEGO DE LLAVES DE VASO 1/4" CON PUNTA EN REGLETA

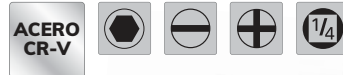

COMPOSICIÓN

5 ● 3, 4, 5, 6, 8 mm 3 ⊕ PH1, PH2, PH3
4 ⊖ 0.8x4.0, 1.0x5.5, 1.2x6.5, 1.2x8.0 mm

Cód.	Nº piezas	P.V.P. unid. €	
192050	12	34,18	1

JUEGO DE LLAVES DE VASO DE 1/4" EN REGLETA



COMPOSICIÓN

4, 5, 6, 7, 8, 9, 10, 11, 12 y 13 mm

Cód.	Nº piezas	P.V.P. unid. €	
170752	10	11,34	10

EXPOSITOR DE VASOS DE 1/4"

COMPOSICIÓN

120 Vasos de 1/4" (10 unidades de cada medida)
192101, 192102, 192103, 192104, 192105, 192106,
192107, 192108, 192109, 192110, 192111, 192112

130 Vasos con punta y vasos de 1/4" largos
(10 unidades de cada medida)
192021, 192022, 192003, 192004, 192005, 192006,
192008, 192014, 192015, 192016, 192122, 192124,
192127

Cód.	Nº piezas	P.V.P. unid. €	
192100	250	732,35	1



Longitud del expositor: 480 mm.

MANGO ATORNILLADOR DE 1/4"



■ Terminación cromado mate.



Cód.	L mm	P.V.P. unid. €	
192145	150	7,66	6

MANGO ATORNILLADOR FLEXIBLE DE 1/4"



■ Terminación cromado mate.



Cód.	L mm	P.V.P. unid. €	
192155	200	14,27	6

Sólo para aprietes a la derecha. Con hexágono exterior.





ALARGADERA DE 1/4"



Con hexágono exterior.

- Terminación cromado mate.

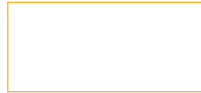

Cód.	L mm	P.V.P. unid. €	
192160	50	3,32	6
192161	75	4,11	6
192162	100	4,54	6
192163	150	5,48	6



ALARGADERA FLEXIBLE DE 1/4"



- Terminación cromado mate.



Cód.	L mm	P.V.P. unid. €	
192150	150	6,22	6

Sólo para aprietes a la derecha. Con hexágono exterior.

07



MANGO EN T DE 1/4"



- Terminación cromado mate.



Cód.	L mm	P.V.P. unid. €	
192164	100	7,70	6



JUNTA UNIVERSAL DE 1/4"



- Terminación cromado mate.



Cód.	L mm	D mm	P.V.P. unid. €	
192165	40	14	6,57	10



ADAPTADOR DE 1/4" PARA PUNTAS DE 1/4"



- Terminación cromado mate.



Cód.	L mm	D mm	P.V.P. unid. €	
192170	25	12	3,57	10

Con muelle de retención de puntas.



ADAPTADOR DE 1/4"



- Terminación cromado mate.



Cód.	Hembra	Macho	P.V.P. unid. €	
192605	1/4"	3/8"	3,81	10



JUEGO DE LLAVES DE VASO DE 3/8"



CON ADAPTADORES PARA HERRAMIENTA ELÉCTRICA Y NEUMÁTICA

COMPOSICIÓN

- 1 Carraca extensible
- 14 Vasos 8 a 22 mm
- 6 Vasos largos 8, 10, 12, 13, 17, 19 mm
- 2 Llaves bujía 16, 21 mm
- 24 Puntas 1/4"
4 ● 3, 4, 5, 6 mm 4 ⊕ PH0, PH1, PH2, PH3
4 ⊖ 4, 5,5, 7, 8 mm 4 ⊕ PZ0, PZ1, PZ2, PZ3
8 ⊕ T8, T9, T10, T15, T20, T25, T27, T30
- 2 Alargaderas 75, 125 mm
- 1 Junta universal
- 1 Adaptador 3/8" M x 1/2" H
- 1 Adaptador Puntas 1/4"
- 1 Adaptador vasos 3/8"
- 1 Adaptador puntas 1/4"



Cód.	Nº piezas	P.V.P. unid. €	
192287	54	110,28	1

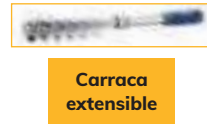

Dimensión caja: 365x240x85 mm.

07



LLAVE DE CARRACA DE 3/8" CON MANGO EXTENSIBLE



- Con expulsor de vasos y reversor.
- Mango ergonómico bimaterial.
- Longitud ajustable a 6 medidas entre 215 y 315 mm.



Cód.	L mín. / L máx. mm	P.V.P. unid. €	
192244	215/315	34,53	5



Se suministra en colgador.



LLAVE DE CARRACA DE 3/8"



- Con expulsor de vasos y reversor.



Cód.	L mm	P.V.P. unid. €	
192243	202	27,39	5

Se suministra en colgador.



LLAVE DE CARRACA CORTA DE 3/8"



- Con expulsor de vasos y reversor.



Cód.	L mm	P.V.P. unid. €	
192246	140	22,24	5

Se suministra en colgador.



LLAVE DE CARRACA DE 3/8"



- Mecanismo reversor mediante palanca.
- Mecanismo de retención y expulsión de vasos por botón.



Cód.	L mm	P.V.P. unid. €	
170725	200	19,11	5

Se suministra en colgador.

07



LLAVE DE VASO DE 3/8"



- Terminación cromado mate.

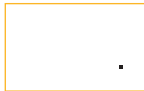

Cód.	mm	L mm	D1 mm	D2 mm	P.V.P. unid. €	
192208	8	28	11,8	16,8	2,73	10
192209	9	28	13,2	16,8	2,81	10
192210	10	28	14,5	16,8	2,93	10
192211	11	28	15,7	16,8	3,00	10
192212	12	28	16,8	16,0	3,03	10
192213	13	28	17,8	16,5	3,10	10
192214	14	28	19,6	17,0	3,31	10

Cód.	mm	L mm	D1 mm	D2 mm	P.V.P. unid. €	
192215	15	28	20,8	18,0	3,43	10
192216	16	30	21,8	19,0	3,60	10
192217	17	30	23,4	20,0	3,79	10
192218	18	30	24,6	21,0	3,88	10
192219	19	30	25,8	23,0	4,03	10
192221	21	32	27,8	25,0	4,19	10
192222	22	32	29,6	26,0	4,31	10



LLAVE DE VASO DE 3/8", SERIE LARGA



- Terminación cromado mate.

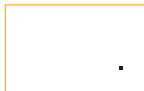

Cód.	mm	L mm	D1 mm	D2 mm	P.V.P. unid. €	
192228	8	63	11,8	16,9	4,65	10
192230	10	63	14,5	16,9	4,67	10
192232	12	63	16,9	16,0	4,84	10
192233	13	63	17,9	16,5	4,94	10
192237	17	63	23,4	20,0	5,92	10
192239	19	63	25,8	23,0	6,24	10



JUEGO DE LLAVES DE VASO DE 3/8" EN REGLETA



COMPOSICIÓN

8, 9, 10, 11, 12, 13, 14, 15, 16, 17, 18 mm

Cód.	Nº piezas	P.V.P. unid. €	
192225	11	27,51	1



ALARGADERA DE 3/8"



192250



192255
192260

Cód.	L mm	P.V.P. unid. €	
192250	75*	4,95	6
192255	75	5,16	6
192260	150	6,75	6



*192250:
Alargadera angular,
con cuadradillo
redondeado.



Con hexágono
exterior.

*Alargadera angular, con cuadradillo redondeado.

07



JUNTA UNIVERSAL DE 3/8"



Cód.	L mm	D mm	P.V.P. unid. €	
192265	54	16	8,96	6



ADAPTADOR DE 3/8"



192610



192615



Cód.	Hembra	Macho	P.V.P. unid. €	
192610	3/8"	1/4"	5,36	10
192615	3/8"	1/2"	7,03	10

Con agujero para mango en T.



ADAPTADOR DE 3/8" PARA PUNTAS



Cód.	para puntas	P.V.P. unid. €	
192270	1/4"	5,80	6



ADAPTADOR DE 3/8" PARA PUNTAS



Cód.	para puntas	P.V.P. unid. €	
186185	3/8"	4,53	6



JUEGO DE LLAVES DE VASO DE 1/2"



CON ADAPTADORES PARA HERRAMIENTA ELÉCTRICA Y NEUMÁTICA

COMPOSICIÓN

- 1 Carraca extensible
- 16 Vasos 10 a 32 mm
- 2 Alargaderas 125, 250 mm
- 24 Puntas 5/16"
6 Ⓞ 4, 5, 6, 8, 10, 12 mm
4 Ⓟ 5.5, 7, 8, 10 mm
- 1 Junta universal
- 1 Adaptador 3/8"H x 1/2"M
- 1 Adaptador Puntas 5/16"
- 4 Ⓢ PH1, PH2, PH3, PH4
4 Ⓢ PZ1, PZ2, PZ3, PZ4
- 1 Adaptador vasos 1/2"
- 1 Adaptador puntas 5/16"
- 6 Ⓞ T30, T40, T45, T50, T55, T60

Cód.	Nº piezas	P.V.P. unid. €	
192384	48	124,77	1



Carraca extensible



Dimensión caja: 365x240x85 mm.

07



JUEGO DE LLAVES DE VASO DE 1/2"- PULGADAS



CON ADAPTADORES PARA HERRAMIENTA ELÉCTRICA Y NEUMÁTICA

COMPOSICIÓN

- 1 Carraca extensible
- 15 Vasos 3/8", 7/16", 1/2", 9/16", 5/8", 11/16", 3/4", 13/16", 7/8", 15/16", 1", 1-1/16", 1-1/8", 1-3/16", 1-1/4"
- 24 Puntas 5/16"
6 Ⓞ 4, 5, 6, 8, 10, 12 mm
4 Ⓟ 5.5, 7, 8, 10 mm
- 1 Junta universal
- 1 Adaptador 3/8"H x 1/2"M
- 1 Adaptador Puntas 5/16"
- 4 Ⓢ PH1, PH2, PH3, PH4
4 Ⓢ PZ1, PZ2, PZ3, PZ4
- 2 Alargaderas 125, 250 mm
- 1 Adaptador vasos 1/2"
- 1 Adaptador puntas 5/16"
- 6 Ⓞ T30, T40, T45, T50, T55, T60

Cód.	Nº piezas	P.V.P. unid. €	
190240	47	121,06	1



Carraca extensible



Dimensión caja: 365x240x85 mm.



JUEGO DE LLAVES DE VASO DE 1/2"



CAJA CON CIERRES Y BISAGRAS METÁLICAS

COMPOSICIÓN

- 10 Vasos 10 a 19 mm
- 1 Alargadera 125 mm
- 25 Puntas 5/16"
7 Ⓞ 4, 5, 6, 7, 8, 10, 12 mm
3 Ⓟ 5.5, 6.5, 8 mm
- 1 Adaptador puntas 5/16"
- 1 Carraca extensible
- 3 Ⓢ PH1, PH2, PH3
3 Ⓢ PZ1, PZ2, PZ3
- 9 Ⓞ T10, T15, T20, T25, T30, T40, T45, T50, T55

Cód.	Nº piezas	P.V.P. unid. €	
192383	38	82,08	1



Carraca extensible



Dimensión caja: 330x160x60 mm.



JUEGO DE LLAVES DE VASO DE 1/2"



COMPOSICIÓN

16 Vasos 10 a 32 mm	1 Carraca	2 Alargaderas 125, 250 mm
1 Junta universal	1 Adaptador 1/2"M x 3/8"H	1 Adapt. vasos 1/2" 1/2"M. x 1/4"M. Hex.
1 Adapt. puntas 5/16"	1 Adap. Puntas 5/16"	24 Puntas 5/16" (various drive types)

Cód.	Nº piezas	P.V.P. unid. €	
192388	48	86,93	1



Dimensión caja: 290x210x80 mm.



LLAVE DE CARRACA DE 1/2" CON MANGO EXTENSIBLE



07



POSIBILIDAD DE AJUSTE A 6 LONGITUDES DIFERENTES

Cabeza cerrada. Evita la entrada de suciedad en el mecanismo interno.



Cód.	L mín./L máx. mm	P.V.P. unid. €	
192344	302/442	49,19	3

Se suministra con colgador.



LLAVE DE CARRACA DE 1/2"



■ Con expulsor de vasos y reversor.



Cód.	L mm	P.V.P. unid. €	
192343	270	33,34	3

Se suministra con colgador.



LLAVE DE CARRACA CORTA DE 1/2"



■ Con expulsor de vasos y reversor.



Cód.	L mm	P.V.P. unid. €	
192348	174	27,91	5

Se suministra con colgador.



LLAVE DE CARRACA DE 1/2"



DIN 3122 ACERO CR-V 72^{5º} Dientes 1/2

- Mecanismo reversioner mediante palanca.
- Mecanismo de retención y expulsión de vasos por botón.



Cód.	L mm	P.V.P. unid. €	
170720	250	22,21	5

Se suministra con colgador.



JUEGO DE LLAVES DE VASO DE 1/2"



ACERO CR-V 72^{5º} Dientes 1/2

COMPOSICIÓN

10 Vasos 10, 11, 12, 13, 14, 15, 17, 19, 22 y 24 mm

1 Carraca 1 Alargadera 100 mm



Cód.	Nº Piezas	P.V.P. unid. €	
170756	12	42,61	5

Se suministra en blíster.



LLAVE DE VASO DE 1/2"

DIN 3124 ACERO CR-V 1/2

- Terminación cromado mate.

Cód.	mm	L mm	P.V.P. unid. €	
192308	8	38	2,83	10
192310	10	38	3,28	10
192311	11	38	3,34	10
192312	12	38	3,53	10
192313	13	38	3,67	10
192314	14	38	3,99	10
192315	15	38	4,04	10
192316	16	38	4,09	10
192317	17	38	4,25	10
192318	18	38	4,25	10
192319	19	38	4,38	10
192320	20	38	4,86	10

Cód.	mm	L mm	P.V.P. unid. €	
192321	21	38	4,86	10
192322	22	38	5,14	10
192323	23	40	5,28	10
192324	24	42	5,55	10
192325	25	42	5,67	10
192326	26	42	5,85	10
192327	27	43	6,04	10
192328	28	46	6,13	5
192329	29	46	6,25	5
192330	30	46	6,74	5
192332	32	46	6,87	5





LLAVE DE VASO DE 1/2" - PULGADAS

DIN 3124

ACERO CR-V



■ Terminación cromado mate.

Cód.	Ø "	L mm	P.V.P. unid. €	
190202	3/8"	38	3,28	1
190204	7/16"	38	3,34	1
190206	1/2"	38	3,53	1
190208	9/16"	38	3,99	1
190210	5/8"	38	4,08	1
190212	11/16"	38	4,25	1
190214	3/4"	38	4,38	1
190216	13/16"	38	4,86	1

Cód.	Ø "	L mm	P.V.P. unid. €	
190218	7/8"	38	5,14	1
190220	15/16"	38	5,28	1
190222	1"	41	5,55	1
190224	1-1/16"	42	6,04	1
190226	1-1/8"	42	6,28	1
190228	1-3/16"	44	6,74	1
190230	1-1/4"	44	6,87	1



LLAVE DE VASO DE 1/2", SERIE LARGA

DIN 3124

ACERO CR-V



■ Terminación cromado mate.

07

Cód.	Ø mm	L mm	P.V.P. unid. €	
190498	8	77	8,51	5
192501	10	77	8,64	5
192502	11	77	8,77	5
192503	12	77	8,77	5
192504	13	77	8,94	5
192505	14	77	9,86	5
192506	15	77	9,86	5
192507	16	77	9,86	5
192508	17	77	9,86	5
192509	18	77	9,86	5
192510	19	77	9,86	5
192511	20	77	10,09	5

Cód.	Ø mm	L mm	P.V.P. unid. €	
192512	21	77	10,09	5
192513	22	77	11,25	5
190523	23	77	11,43	5
192514	24	77	11,74	5
190525	25	77	11,91	5
190526	26	77	12,27	5
192515	27	77	12,52	3
190528	28	77	13,34	3
190529	29	77	14,05	3
192516	30	77	14,35	3
192517	32	77	15,54	3



LLAVE DE VASO DE 1/2", BIHEXAGONAL

DIN 3124

ACERO CR-V



■ Terminación cromado mate.

Cód.	Ø mm	L mm	P.V.P. unid. €	
190408	8	38	3,27	10
190410	10	38	3,29	10
190411	11	38	3,34	10
190412	12	38	3,53	10
190413	13	38	3,66	10
190414	14	38	3,99	10
190415	15	38	4,04	10
190416	16	38	4,09	10
190417	17	38	4,25	10
190418	18	38	4,25	10
190419	19	38	4,38	10
190420	20	38	4,86	10

Cód.	Ø mm	L mm	P.V.P. unid. €	
190421	21	38	4,86	10
190422	22	38	5,14	10
190423	23	40	5,28	10
190424	24	42	5,55	10
190425	25	42	5,72	10
190426	26	43	5,89	10
190427	27	43	6,03	10
190428	28	43	6,25	5
190429	29	46	6,55	5
190430	30	46	6,74	5
190432	32	46	6,87	5





LLAVE DE VASO DE 1/2" BIHEXAGONAL, SERIE LARGA

■ Terminación cromado mate.

Cód.	mm	L mm	P.V.P. unid. €	
190678	8	77	8,51	5
190680	10	77	8,65	5
190681	11	77	8,76	5
190682	12	77	8,76	5
190683	13	77	8,94	5
190684	14	77	9,86	5
190685	15	77	9,86	5
190686	16	77	9,86	5
190687	17	77	9,86	5
190688	18	77	9,86	5
190689	19	77	9,86	5
190690	20	77	10,10	5

Cód.	mm	L mm	P.V.P. unid. €	
190691	21	77	10,10	5
190692	22	77	11,25	5
190693	23	77	11,43	5
190694	24	77	11,74	5
190695	25	77	11,91	5
190696	26	77	12,27	5
190697	27	77	12,52	5
190698	28	77	13,34	5
190699	29	77	14,05	5
190700	30	77	14,35	5
190702	32	77	15,54	5



07



LLAVE DE VASO DE 1/2" TORX HEMBRA (TIPO E)

■ Terminación cromado mate.

Cód.	mm	L mm	P.V.P. unid. €	
192294	E10	38	4,90	4
192295	E12	38	4,90	4
192296	E14	38	4,90	4
192297	E16	38	5,07	4

Cód.	mm	L mm	P.V.P. unid. €	
192298	E18	38	5,07	4
192299	E20	38	5,46	4
192300	E24	38	6,03	4



JUEGO DE LLAVES DE VASO DE 1/2" EN REGLETA

COMPOSICIÓN

10, 11, 12, 13, 14, 15, 16, 17, 18, 19 mm



Cód.	Nº Piezas	P.V.P. unid. €	
192333	10	31,68	1

JUEGO DE LLAVES DE VASO DE 1/2" EN REGLETA

COMPOSICIÓN

17, 19, 20, 21, 22, 24, 27, 30, 32 mm



Cód.	Nº Piezas	P.V.P. unid. €	
192334	9	35,84	1



JUEGO DE LLAVES DE VASO DE 1/2" BIHEXAGONALES, EN REGLETA

COMPOSICIÓN

10, 11, 13, 14, 15, 16, 17, 19, 21, 22 mm



Cód.	Nº Piezas	P.V.P. unid. €	
190433	10	34,30	1



JUEGO DE LLAVES DE VASO DE 1/2" SERIE LARGA, EN REGLETA

ACERO CR-V 6 Caras 1/2" ■ Terminación cromado mate.



COMPOSICIÓN

10, 11, 13, 14, 15, 16, 17, 19, 21, 22 mm

Cód.	Nº Piezas	P.V.P. unid. €	
192518	10	77,52	1

JUEGO DE LLAVES DE VASO DE 1/2" BIHEXAGONALES, LARGOS, EN REGLETA

ACERO CR-V 12 Caras 1/2" ■ Terminación cromado mate.



COMPOSICIÓN

10, 11, 13, 14, 15, 16, 17, 19, 21, 22 mm

Cód.	Nº Piezas	P.V.P. unid. €	
190703	10	77,52	1

JUEGO DE LLAVES DE VASO DE 1/2" EN REGLETA

ACERO CR-V 1/2" ■ Terminación cromado mate.



COMPOSICIÓN

10, 11, 12, 13, 14, 15, 16, 17, 18, 19 mm

Cód.	Nº Piezas	P.V.P. unid. €	
170757	10	21,61	5

JUEGO DE LLAVES DE VASO DE 1/2" EN REGLETA

ACERO CR-V 1/2" ■ Terminación cromado mate.



COMPOSICIÓN

19, 20, 21, 22, 24, 27, 30 y 32 mm

Cód.	Nº Piezas	P.V.P. unid. €	
170758	8	28,95	5

EXPOSITOR DE LLAVES DE VASO DE 1/2"

ACERO CR-V 1/2"

COMPOSICIÓN

165 vasos de 1/2" (10 unidades de cada medida)
 192310, 192311, 192312, 192313, 192314, 192315,
 192316, 192317, 192318, 192319, 192320, 192321,
 192322, 192323, 192324.
 192327, 192330, 192332, (5 unidades de cada medida)
 25 vasos de 1/2" largos (5 unidades de cada medida)
 192501, 192504, 192508, 192510, 192514 (Serie larga)
 1 Expositor de llaves de vaso / 23 divisores metálicos.

Cód.	Nº Piezas	P.V.P. unid. €	
192305	190	1.065,77	1



Longitud del expositor: 770 mm



ALARGADERA DE 1/2"



■ Terminación cromado mate.

Cód.	L mm	P.V.P. unid. €	
192352	75	6,08	6
192355	125	7,08	6
192356	150	7,88	6
192358	250	11,64	6



Con hexágono exterior



MANGO ARTICULADO DE 1/2"

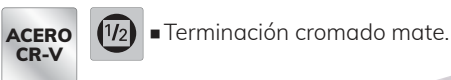

Posibilidad de giro de la articulación a diferentes ángulos entre 0° y 180°.



Cód.	L mm	P.V.P. unid. €	
192362	385	27,39	1



MANGO EN T DE 1/2"



Cód.	L mm	P.V.P. unid. €	
192360	250	14,62	6



JUNTA UNIVERSAL DE 1/2"



■ Terminación cromado mate.



Cód.	L mm	P.V.P. unid. €	
192365	73,5	11,91	6



ADAPTADOR DE 1/2"



Cód.	Hembra	Macho	P.V.P. unid. €	
192620	1/2"*	3/8"	7,14	10
192625	1/2"	3/4"	11,31	10

* Con agujero pasante para mango en T



ADAPTADOR DE 1/2" PARA PUNTAS DE 5/16"



■ Terminación cromado mate.
■ Para carraca de 1/2" y puntas de 5/16".



Cód.	para puntas	P.V.P. unid. €	
192363	5/16"	5,95	4



ADAPTADOR DE 1/2" PARA PUNTAS DE 3/8"



■ Terminación cromado mate.
■ Para carraca de 1/2" y puntas de 3/8".



Cód.	para puntas	P.V.P. unid. €	
186187	3/8"	4,76	6

 LLAVE DE VASO DE 1/2", ALLEN



Cód.	mm	L mm	P.V.P. unid. €	
192405	5	55	7,30	10
192406	6	55	7,30	10
192407	7	55	7,43	10
192408	8	55	7,50	10
192409	9	55	7,55	10
192410	10	55	7,58	10
192412	12	55	7,82	10
192414	14	55	8,69	10
192417	17	55	11,15	10

 LLAVE DE VASO DE 1/2", TORX INVIOLEBLE



Cód.		L mm	P.V.P. unid. €	
192420	T20	55	8,53	10
192425	T25	55	8,56	10
192427	T27	55	8,63	10
192430	T30	55	8,66	10
192440	T40	55	8,70	10
192445	T45	55	8,84	10
192450	T50	55	9,38	10
192455	T55	55	9,41	10
192460	T60	55	9,61	10

07

 JUEGO DE LLAVES DE VASO DE 1/2", PUNTA ALLEN, EN REGLETA



COMPOSICIÓN

5, 6, 7, 8, 9, 10, 12, 14, 17 mm

Cód.	Nº Piezas	P.V.P. unid. €	
192470	9	59,54	1

 JUEGO DE LLAVES DE VASO DE 1/2", PUNTA TORX INVIOLEBLE, EN REGLETA



COMPOSICIÓN

T20, T25, T27, T30, T40, T45, T50, T55, T60

Cód.	Nº Piezas	P.V.P. unid. €	
192480	9	64,30	1

 LLAVE DE VASO DE 1/2", TORX



Cód.		L mm	P.V.P. unid. €	
190720	T20	55	8,53	10
190725	T25	55	8,56	10
190727	T27	55	8,63	10
190730	T30	55	8,66	10
190740	T40	55	8,70	10
190745	T45	55	8,84	10
190750	T50	55	9,38	10
190755	T55	55	9,42	10
190760	T60	55	9,61	10

 JUEGO DE LLAVES DE VASO DE 1/2", PUNTA TORX, EN REGLETA



COMPOSICIÓN

T20, T25, T27, T30, T40, T45, T50, T55, T60

Cód.	Nº Piezas	P.V.P. unid. €	
190765	9	64,30	1



LLAVE DE VASO DE 1/2", XZN



Cód.	●	L mm	P.V.P. unid. €	📦
192481	M6	55	9,59	10
192482	M8	55	9,78	10
192483	M10	55	10,09	10
192484	M12	55	10,76	10
192485	M14	55	11,15	10
192486	M16	55	12,46	10



LLAVE DE VASO DE 1/2", RIBE



Cód.	⊕	L mm	P.V.P. unid. €	📦
190767	M7	55	7,43	10
190770	M10	55	7,50	10
190774	M14	55	7,55	10
190776	M16	55	11,16	10

07



LLAVE DE VASO DE 1/2", ALLEN LARGO



Cód.	● mm	L mm	P.V.P. unid. €	📦
190705	5	100	7,30	10
190706	6	100	7,30	10
190707	7	100	7,43	10
190708	8	100	7,50	10
190710	10	100	7,55	10
190712	12	100	11,15	10



LLAVE DE VASO DE 1/2", TORX LARGO



Cód.	★	L mm	P.V.P. unid. €	📦
190741	T40	100	7,30	10
190746	T45	100	7,43	10
190751	T50	100	7,50	10
190756	T55	100	7,55	10
190761	T70	100	11,15	10



LLAVE DE VASO DE 1/2", XZN LARGO



Cód.	●	L mm	P.V.P. unid. €	📦
192475	M6	100	7,43	10
192476	M8	100	7,50	10
192477	M10	100	7,55	10
192478	M12	100	11,15	10



LLAVE DE VASO DE 1/2", RIBE LARGO



Cód.	⊕	L mm	P.V.P. unid. €	📦
190768	M7	100	9,59	10
190771	M10	100	9,78	10
190775	M14	100	10,09	10
190777	M16	100	12,46	10



JUEGO DE LLAVES DE VASO DE 1/4" - AISLADO

CERTIFICADO VDE



NORMA EN 60900:
Herramientas aisladas utilizadas para trabajos en tensiones de hasta 1000V en Corriente Alterna ó 1500V en Corriente Continua.

COMPOSICIÓN

10 Vasos aislados 1/4" 5 a 14 mm	2 Alargaderas aisladas 100, 150 mm		
4 Vasos aislados punta hexagonal 3 a 6 mm	1 Mango en T aislado 125 mm	1 Carraca aislada	
Cód.	Nº Piezas	P.V.P. unid. €	
190302	18	281,81	1



Dimensión caja: 280x260x65 mm.



LLAVE DE CARRACA DE 1/4" - AISLADA

CERTIFICADO VDE



- Mango y cuerpo de la carraca recubiertos de material aislante.
- Carraca con expulsor de vasos y reversible.
- Mango bimaternal con forma ergonómica.

Cód.	L mm	P.V.P. unid. €	
190390	150	65,60	1



07



VASO DE 1/4" CON PUNTA HEXAGONAL - AISLADO

CERTIFICADO VDE



Cód.	mm	L mm	P.V.P. unid. €	
190383	3	55	7,16	1
190384	4	55	7,16	1
190385	5	55	7,16	1
190386	6	55	7,16	1



LLAVE DE VASO DE 1/4" - AISLADA

CERTIFICADO VDE



Cód.	mm	L mm	P.V.P. unid. €	
190365	5	40	6,13	1
190366	6	40	6,13	1
190367	7	40	6,13	1
190368	8	40	6,13	1
190369	9	40	6,13	1
190370	10	40	6,13	1
190371	11	40	6,25	1
190372	12	40	6,30	1
190373	13	40	6,39	1
190374	14	40	6,41	1



ALARGADERA DE 1/4" AISLADA

CERTIFICADO VDE



Cód.	L mm	P.V.P. unid. €	
190392	100	23,14	1
190393	150	26,63	1



MANGO EN T DE 1/4" AISLADO

CERTIFICADO VDE



Cód.	L mm	P.V.P. unid. €	
190391	125	38,92	1



JUEGO DE LLAVES DE VASO DE 1/2" - AISLADOS

CERTIFICADO **VDE**



NORMA EN 60900:
Herramientas aisladas utilizadas para trabajos en tensiones de hasta 1000V en Corriente Alterna ó 1500V en Corriente Continua.

COMPOSICIÓN

- 11 Vasos aislados 1/2" 10 a 32 mm
- 2 Alargaderas aisladas 125, 250 mm
- 5 Vasos aislados 1/2" punta hexagonal 4 a 10 mm
- 1 Mango en T aislado
- 1 Carraca aislada

Cód.	Nº Piezas	P.V.P. unid. €	
190300	20	438,98	1



Dimensión caja:
380x310x65 mm.



LLAVE DE CARRACA DE 1/2" - AISLADA

CERTIFICADO **VDE**



- Mango y cuerpo de la carraca recubiertos de material aislante.
- Mango bimataterial con forma ergonómica.
- Carraca con expulsor de vasos y reversible.



Cód.	L mm	P.V.P. unid. €	
190305	250	89,31	1



VASO DE 1/2" AISLADO PUNTA HEXAGONAL

CERTIFICADO **VDE**



Cód.	mm	L mm	P.V.P. unid. €	
190354	4	75	10,33	2
190355	5	75	12,10	2
190356	6	75	12,10	2
190358	8	75	12,10	2
190360	10	75	12,53	2



ALARGADERA DE 1/2" - AISLADA

CERTIFICADO **VDE**



Cód.	L mm	P.V.P. unid. €	
190342	125	41,52	1
190345	250	46,49	1



LLAVE DE VASO DE 1/2" - AISLADA

CERTIFICADO **VDE**



Cód.	mm	L mm	P.V.P. unid. €	
190308	8	55	9,13	3
190310	10	55	9,13	3
190311	11	55	9,13	3
190312	12	55	9,13	3
190313	13	55	9,13	3
190314	14	55	9,13	3
190315	15	55	9,34	3
190316	16	55	9,34	3
190317	17	55	9,34	3
190318	18	57	9,39	3
190319	19	57	9,67	3
190320	20	57	10,33	3
190321	21	57	10,33	3
190322	22	57	10,66	3
190324	24	57	11,29	3
190327	27	59	15,38	2
190330	30	59	15,57	2
190332	32	59	16,53	2



MANGO EN T DE 1/2" - AISLADO

CERTIFICADO **VDE**



Cód.	L mm	P.V.P. unid. €	
190340	250	55,81	1





JUEGO DE LLAVES DE VASO DE 3/8" - AISLADOS

CERTIFICADO VDE

ACERO CR-V 45 Dientes 8° 1000 V 3/8

NORMA EN 60900:
Herramientas aisladas utilizadas para trabajos en tensiones de hasta 1000V en Corriente Alterna ó 1500V en Corriente Continua.

COMPOSICIÓN

- 8 Vasos aislados 3/8" 8,10,12,13,14,17,19,22 mm
- 2 Alargaderas aisladas 167, 267 mm
- 4 Vasos aislados 3/8" punta hexagonal 4,5,6,8 mm
- 1 Mango en T aislado 200 mm
- 1 Carraca aislada

Cód.	Nº Piezas	P.V.P. unid. €	
190304	16	356,78	1



Dimensión caja: 380x310x65 mm.



07



JUEGO DE LLAVES DE VASO DE 3/4"

ACERO CR-V 24 Dientes 15° 3/4

- Terminación cromado.
- Mango desmontable.

COMPOSICIÓN

- 14 Vasos 19, 21, 22, 24, 27, 30, 32, 33, 34, 36, 38, 41, 46, 50 mm
- 1 Mango en "T" 400 mm
- 1 Carraca mango desmontable
- 2 Alargaderas 200, 400 mm

Cód.	Nº Piezas	P.V.P. unid. €	
192580	18	369,15	1



Dimensión caja: 540x180x80 mm.



JUEGO DE LLAVES DE VASO DE 3/4"

ACERO CR-V 24 Dientes 15° 3/4

- Terminación cromado.
- Mango desmontable.

COMPOSICIÓN

- 10 Vasos 22, 24, 27, 30, 32, 36, 38, 41, 46, 50 mm
- 1 Mango en "T" 400 mm
- 1 Carraca mango desmontable
- 2 Alargaderas 100, 200 mm

Cód.	Nº Piezas	P.V.P. unid. €	
192582	14	236,97	1



Dimensión caja: 530x280x85 mm.





LLAVE DE CARRACA DE 3/4"



- Con expulsor de vasos y reversor.
- Mango metálico con acabado rugoso.
- Presentación cromado.



MANGO DESMONTABLE

Cód.	L mm	P.V.P. unid. €	
192555	495	99,19	1

07



LLAVE DE VASO DE 3/4"



- Terminación cromado mate.

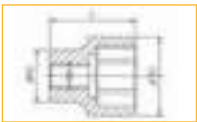

Cód.	mm	L mm	D1 mm	D2 mm	P.V.P. unid. €	
192519	19	50	29	33	10,22	1
192521	21	50	31	33	10,22	1
192522	22	50	32	36	10,22	1
192524	24	51	34	36	10,84	1
192527	27	52	38	36	11,27	1
192530	30	54	42	38	12,59	1
192532	32	56	44	38	12,95	1
192533	33	56	46	38	14,33	1
192534	34	56	47	38	14,33	1
192536	36	58	50	42	14,69	1
192538	38	60	52	45	16,34	1
192541	41	64	56	45	17,82	1
192546	46	68	62	48	21,10	1
192550	50	72	68	48	24,19	1



LLAVE DE CARRACA DE 3/4"



- Con expulsor de vasos y reversor.
- Mango metálico con acabado rugoso.
- Cabeza pavonada y mango cromado.



MANGO DESMONTABLE

Cód.	L mm	P.V.P. unid. €	
170730	500	78,20	1



ALARGADERA DE 3/4"



Cód.	L mm	P.V.P. unid. €	
192565	100	15,47	1
192570	200	21,62	1
192575	400	35,13	1



MANGO EN T DE 3/4"



Cód.	L mm	P.V.P. unid. €	
192560	450	33,38	1



ADAPTADOR DE 3/4"



Cód.	Hembra	Macho	P.V.P. unid. €	
192630	3/4"	1/2"	14,29	1
192632	3/4"	1"	19,84	1



JUEGO DE LLAVES DE VASO DE 1"

ACERO CR-V 24^{15°} Dientes 12 Caras 1

■ Terminación cromado.

COMPOSICIÓN

- 1 Carraca mango desmontable
- 1 Mango en T 560 mm
- 2 Alargadera 200, 400 mm
- 10 Vasos bihexagonales 36, 41, 46, 50, 55, 60, 65, 70, 75, 80 mm

Cód.	Nº Piezas	P.V.P. unid. €	
194820	14	884,48	1



Dimensión caja: 650x210x110 mm.



LLAVE DE CARRACA DE 1"

DIN 3122 ACERO CR-V 24^{15°} Dientes 1

Cód.	L mm	P.V.P. unid. €	
194885	660	205,53	1



MANGO DESMONTABLE

07



LLAVE DE VASO DE 1" BIHEXAGONAL

DIN 3124 ACERO CR-V 12 Caras 1

■ Terminación cromado brillante.

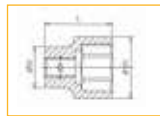

Cód.	mm	L mm	D1 mm	D2 mm	P.V.P. unid. €	
194836	36	65	52	45	24,11	1
194841	41	70	57	45	29,23	1
194846	46	75	65	50	34,60	1
194850	50	75	70	55	39,69	1
194855	55	80	76	57	45,32	1
194860	60	85	85	57	55,15	1
194865	65	87	87	57	65,90	1
194870	70	94	94	68	74,25	1
194875	75	98	100	68	83,17	1
194880	80	102	105	68	95,24	1



ALARGADERA DE 1"

DIN 3123 ACERO CR-V 1

Cód.	L mm	P.V.P. unid. €	
194886	200	52,80	1
194887	400	53,90	1



MANGO EN T DE 1"

DIN 3123 ACERO CR-V 1

Cód.	L mm	P.V.P. unid. €	
194888	560	67,85	1



ADAPTADOR DE 1"

DIN 3123 ACERO CR-V 1

Cód.	Hembra	Macho	P.V.P. unid. €	
194890	1"	3/4"	31,69	1



LLAVE DE VASO DE IMPACTO

ACERO CR-MO

- 1 Fabricados en Acero aleado con alto grado de Cromo.
- 2 Tratado térmicamente.
- 3 Fabricados según normas DIN.
- 4 Terminación pavonado.
- 5 Ranuras de desahogo para reducir el estrés interior y evitar dañar las aristas de las tuercas.
- 6 Hexágono y cuadradillo concéntricos para reducir al máximo las vibraciones.
- 7 Diseño compacto para utilizar los vasos en lugares de difícil acceso.

6 Concentricidad



5 Perfil especial



7 Forma compacta

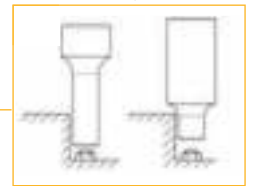

LLAVE DE VASO DE IMPACTO DE 1/2"

DIN 3129

ACERO CR-MO



Cód.	mm	L mm	D1 mm	D2 mm	P.V.P. unid. €	
198208	8	38	15,0	25	6,09	1
198209	9	38	16,0	25	6,09	1
198210	10	38	17,5	25	6,09	1
198211	11	38	18,5	25	6,09	1
198212	12	38	20,0	25	6,09	1
198213	13	38	21,2	25	6,09	1
198214	14	38	22,5	25	6,09	1
198215	15	38	23,7	30	6,79	1
198216	16	38	25,0	30	6,79	1
198217	17	38	26,2	30	6,79	1
198218	18	38	27,5	30	6,99	1
198219	19	38	28,7	30	6,99	1
198220	20	38	30,0	30	7,44	1
198221	21	39	31,2	30	7,75	1
198222	22	39	32,5	30	8,03	1



Cód.	mm	L mm	D1 mm	D2 mm	P.V.P. unid. €	
198223	23	41	33,7	30	8,03	1
198224	24	41	35,0	30	8,73	1
198225	25	44	35,0	30	8,93	1
198226	26	45	37,5	30	9,56	1
198227	27	45	38,7	30	10,54	1
198228	28	50	40,0	30	11,03	1
198229	29	50	40,0	30	11,72	1
198230	30	50	42,5	30	12,76	1
198232	32	50	45,0	30	13,90	1



JUEGO DE LLAVES DE VASO DE IMPACTO DE 1/2", EN REGLETA

ACERO CR-MO



COMPOSICIÓN

10, 11, 13, 14, 15, 16, 17, 19, 21, 22 mm

Cód.	Nº Piezas	P.V.P. unid. €	
198233	10	67,46	1





LLAVE DE VASO DE IMPACTO DE 1/2", SERIE LARGA



Cód.	mm	L mm	D1 mm	D2 mm	P.V.P. unid. €	
198239	8	80	15,0	25	10,51	1
198240	10	80	17,0	25	10,51	1
198249	11	80	18,5	25	10,51	1
198250	12	80	20,0	25	10,51	1
198241	13	80	21,0	25	10,51	1
198251	14	80	22,5	30	10,72	1
198252	15	80	23,5	30	10,72	1
198253	16	80	25,0	30	10,72	1
198242	17	80	26,2	30	11,29	1
198254	18	80	26,5	30	11,29	1
198243	19	80	28,5	30	11,29	1
198255	20	80	30,0	30	11,91	1
198256	21	80	31,0	30	11,91	1
198244	22	80	32,0	30	12,55	1
198257	23	80	34,0	30	13,10	1
198245	24	80	34,0	30	13,63	1



Cód.	mm	L mm	D1 mm	D2 mm	P.V.P. unid. €	
198266	25	80	34,0	30	14,29	1
198267	26	80	36,0	30	14,89	1
198246	27	80	39,0	30	15,60	1
198268	28	80	40,0	30	16,67	1
198269	29	80	40,0	30	17,27	1
198247	30	80	42,5	30	17,81	1
198248	32	80	51,0	30	21,60	1

07



JUEGO DE LLAVES DE VASO DE IMPACTO DE 1/2", SERIE LARGA



COMPOSICIÓN

10, 11, 13, 14, 15, 16, 17, 19, 21, 22 mm

Cód.	Nº Piezas	P.V.P. unid. €	
198258	10	105,98	1



LLAVE DE VASO DE IMPACTO DE 1/2", TORX HEMBRA (TIPO E)



Cód.	mm	L mm	P.V.P. unid. €	
198200	E10	38	7,01	10
198201	E12	38	7,01	10
198202	E14	38	7,01	10
198203	E16	38	7,01	10
198204	E18	38	7,01	10
198205	E20	38	7,23	10
198206	E24	38	8,10	10





LLAVE DE VASO DE IMPACTO DE 1/2" PARA RUEDAS



■ Recubrimiento de plástico exterior para no dañar la llanta.

Cód.	mm	L mm	Ø mm	P.V.P. unid. €	
198902	17	85	30	10,29	1
198904	19	85	30	10,29	1
198906	21	85	30	10,29	1



JUEGO DE LLAVES DE VASO DE IMPACTO DE 1/2" PARA RUEDAS



07

COMPOSICIÓN

17, 19, 21 mm

Cód.	Nº Piezas	P.V.P. unid. €	
198900	3	33,25	1



Dimensión caja: 143x121x49 mm



ALARGADERA DE IMPACTO DE 1/2"



Cód.	L mm	P.V.P. unid. €	
198260	75	9,81	1
198262	125	11,96	1
198265	250	17,08	1



JUNTA UNIVERSAL DE IMPACTO DE 1/2"



Cód.	L mm	P.V.P. unid. €	
198270	67	17,86	1



ADAPTADOR DE IMPACTO DE 1/2"



Cód.	Hembra	Macho	L mm	P.V.P. unid. €	
198275	1/2"	3/4"	49	9,53	1

LLAVE DE VASO DE IMPACTO DE 1/2", PUNTA ALLEN



LLAVE DE VASO DE IMPACTO DE 1/2", PUNTA TORX

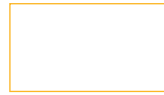
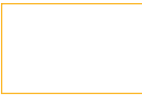

Cód.	mm	L mm	D mm	P.V.P. unid. €	
198285	5	78	25	13,50	1
198286	6	78	25	13,60	1
198288	8	78	25	13,72	1
198290	10	78	25	14,16	1
198292	12	78	25	14,28	1
198294	14	78	30	14,61	1
198297	17	78	30	15,08	1
198299	19	78	30	16,06	1

Cód.		L mm	D mm	P.V.P. unid. €	
198302	T25	78	25	13,72	1
198304	T27	78	25	13,72	1
198306	T30	78	25	13,72	1
198308	T40	78	25	13,85	1
198310	T45	78	25	13,85	1
198312	T50	78	25	13,85	1
198314	T55	78	25	14,34	1
198316	T60	78	25	14,34	1

07

JUEGO DE LLAVES DE VASO DE IMPACTO DE 1/2", PUNTA ALLEN



COMPOSICIÓN

5, 6, 8, 10, 12, 14, 17, 19 mm

Cód.	Nº Piezas	P.V.P. unid. €	
198300	8	107,17	1

JUEGO DE LLAVES DE VASO DE IMPACTO DE 1/2", PUNTA TORX



COMPOSICIÓN

T25, T27, T30, T40, T45, T50, T55, T60

Cód.	Nº Piezas	P.V.P. unid. €	
198301	8	111,38	1

LLAVE DE VASO DE IMPACTO DE 1/2", PUNTA XZN

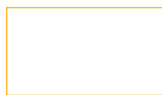

Cód.		L mm	D mm	P.V.P. unid. €	
198180	M6	78	25	12,69	1
198181	M8	78	25	13,04	1
198182	M10	78	25	13,69	1
198183	M12	78	25	13,69	1
198184	M14	78	25	14,05	1
198185	M16	78	25	14,38	1



LLAVE DE VASO DE IMPACTO DE 3/4"



Cód.	Ø mm	L mm	D1 mm	D2 mm	P.V.P. unid. €	
198317	17	51	30,0	44	14,89	1
198319	19	51	32,5	44	14,74	1
198321	21	51	35,0	44	13,99	1
198322	22	51	36,0	44	14,24	1
198324	24	51	38,5	44	16,22	1
198327	27	53	42,5	44	16,24	1
198330	30	53	46,0	44	14,49	1
198332	32	57	48,5	44	15,11	1
198334	34	57	51,0	44	17,62	1
198336	36	57	53,5	44	18,08	1
198338	38	57	56,0	44	24,51	1
198341	41	58	60,0	44	21,71	1
198346	46	62	66,0	44	28,05	1
198350	50	68	71,0	44	31,60	1
198355	55	72	77,5	54	49,89	1
198360	60	72	83,5	54	50,29	1



LLAVE DE VASO DE IMPACTO DE 3/4", SERIE LARGA



Cód.	Ø mm	L mm	D1 mm	D2 mm	P.V.P. unid. €	
198370	17	100	30,0	44	22,67	1
198371	19	100	33,0	44	25,34	1
198372	21	100	35,0	44	22,92	1
198373	22	100	36,0	44	23,45	1
198374	24	100	38,0	44	23,17	1
198375	27	100	42,0	44	23,90	1
198376	30	100	46,0	44	24,25	1
198377	32	100	48,0	44	26,02	1
198378	34	100	51,0	44	27,27	1
198379	36	100	53,0	44	29,54	1
198380	41	100	59,0	44	32,09	1
198381	46	100	66,0	44	36,08	1
198383	50	100	71,0	44	42,87	1
198385	55	100	77,5	44	63,71	1
198387	60	100	83,5	44	72,34	1



ALARGADERA DE IMPACTO DE 3/4"



Cód.	L mm	P.V.P. unid. €	
198382	175	30,88	1
198384	250	37,88	1
198386	325	43,62	1



JUNTA UNIVERSAL DE IMPACTO DE 3/4"



Cód.	L mm	P.V.P. unid. €	
198390	110	69,07	1



ADAPTADOR DE IMPACTO DE 3/4"



Cód.	Hembra	Macho	L mm	P.V.P. unid. €	
198392	3/4"	1/2"	56	20,39	1
198395	3/4"	1"	68	21,22	1





LLAVE DE VASO DE IMPACTO DE 1"

DIN 3129

ACERO CR-MO

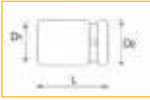

Cód.	mm	L mm	D1 mm	D2 mm	P.V.P. unid. €	
198424	24	57	41,0	54	24,22	1
198427	27	57	45,0	54	25,20	1
198430	30	60	49,0	54	25,90	1
198432	32	60	51,0	54	26,15	1
198434	34	64	54,0	54	26,56	1
198436	36	65	57,0	54	27,03	1
198438	38	66	59,0	54	27,92	1
198441	41	68	63,0	54	30,73	1
198446	46	73	69,0	54	37,99	1
198450	50	70	74,0	54	45,75	1
198455	55	75	81,0	54	51,72	1
198460	60	80	86,0	54	64,03	1
198465	65	92	92,5	54	75,25	1
198470	70	96	99,0	54	84,99	1



LLAVE DE VASO DE IMPACTO DE 1", SERIE LARGA

DIN 3129

ACERO CR-MO



Cód.	mm	L mm	D1 mm	D2 mm	P.V.P. unid. €	
198475	24	108	41,0	54	39,43	1
198476	27	108	45,0	54	39,88	1
198477	30	108	48,0	54	40,15	1
198478	32	108	51,0	54	40,90	1
198479	34	108	54,0	54	41,12	1
198480	36	108	56,0	54	46,53	1
198481	38	108	59,0	54	48,22	1
198482	41	108	62,0	54	51,83	1
198483	46	108	68,0	54	56,25	1
198484	50	108	74,0	54	64,52	1
198485	55	108	80,0	54	94,29	1
198486	60	108	86,5	54	105,17	1
198487	65	108	92,5	54	116,70	1
198488	70	108	99,0	54	140,52	1

07



ALARGADERA DE IMPACTO DE 1"

DIN 3121

ACERO CR-MO



Cód.	L mm	P.V.P. unid. €	
198490	175	47,92	1
198492	325	65,49	1



JUNTA UNIVERSAL DE IMPACTO DE 1"

DIN 3121

ACERO CR-MO



Cód.	L mm	P.V.P. unid. €	
198495	132	77,83	1



ADAPTADOR DE IMPACTO DE 1"

DIN 3121

ACERO CR-MO



Cód.	Hembra	Macho	L mm	P.V.P. unid. €	
198497	1"	3/4"	65	31,25	1



LLAVE DE VASO DE IMPACTO DE 1 - 1/2"

DIN 3129 **ACERO CR-MO**

Cód.	mm	L mm	Ø mm	P.V.P. unid. €		Cód.	mm	L mm	Ø mm	P.V.P. unid. €	
198946	46	84	86	151,50	1	198975	75	103	110	222,68	1
198950	50	87	86	151,50	1	198980	80	110	116	234,59	1
198955	55	90	86	160,76	1	198981	85	118	125	244,12	1
198960	60	92	94	177,43	1	198982	90	118	130	294,67	1
198965	65	95	97	183,38	1	198983	95	118	137	308,65	1
198970	70	100	105	220,30	1	198984	100	125	144	332,24	1



ANILLAS DE IMPACTO DE SEGURIDAD

DIN 3129

Cód.	Utilización	Accesorios Vasos	D1 mm	D2 mm	P.V.P. unid. €	
198276	1/2"	SI	≤ 14	4 19	2,41	5
198277	1/2"	NO	> 14	4 24	2,41	5
198396	3/4"	SI	≤ 50	5 36	2,40	5
198397	3/4"	NO	> 50	5 46	2,41	5
198498	1"	SI	≤ 70	7 45	2,56	5



PASADORES DE IMPACTO DE SEGURIDAD

DIN 3129

Cód.	Utilización	Accesorios Vasos	L mm	D mm	P.V.P. unid. €	
198278	1/2"	SI	≤ 14	20 3	1,66	5
198279	1/2"	NO	> 14	25 3	1,75	5
198398	3/4"	SI	≤ 50	35 4	1,81	5
198399	3/4"	NO	> 50	45 4	2,56	5
198499	1"	SI	≤ 70	45 6	2,56	5

07



JUEGO DE DESTORGOLPE REFORZADO

ACERO CR-V
 ■ Mango ergonómico antideslizante.
 ■ Terminación cromado.
 ■ Tope superior metálico para golpeo.

Dimensión caja: 330x160x60 mm

INCLUYE:

COMPOSICIÓN

	Destorgolpe 1/2" reforzado		Adaptador 3/8" M x 5/16" M		Adaptador 5/16" H x 1/2" H
	18 Puntas impacto 5/16" x 36 mm: 4 ⌀ 6, 8, 10, 12 mm 4 ⚙ PH1, PH2, PH3, PH4		4 ⌀ 4, 5, 6, 8 mm		6 ⚙ T25, T27, T30, T40, T45, T50
Cód.	Nº Piezas	P.V.P. unid. €			
192650	21	54,65	1		



JUEGO DE DESTORGOLPE MÁS ADAPTADORES

ACERO CR-V ■ Terminación pavonado.

INCLUYE:

COMPOSICIÓN

	Destorgolpe 1/2"		Adaptador 3/8" M x 5/16" M		Adaptador 5/16" H x 1/2" H
Cód.	Nº Piezas	P.V.P. unid. €			
192652	3	26,70	1		



ADAPTADOR HEXAGONAL PARA VASOS

ACERO CR-V

Cód.	mm	mm	P.V.P. unid. €	
192648	3/8"	5/16"	1,79	6



ADAPTADOR PARA PUNTAS

ACERO CR-V

Cód.	mm	mm	P.V.P. unid. €	
192649	5/16"	1/2"	1,60	6

08

PERCUSIÓN

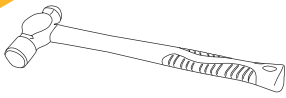

Martillo de bola **226**

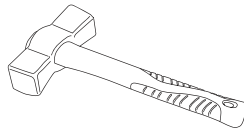

Maceta **228**

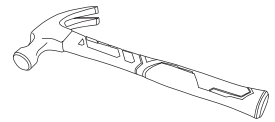

Martillo de carpintero **230**

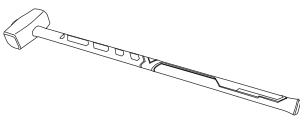

Maza **232**

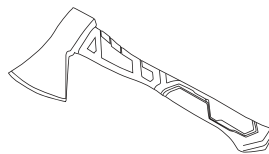

Hacha **233**

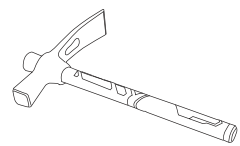

Piqueta y alcotana **234**

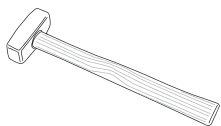

Maceta de cobre **235**

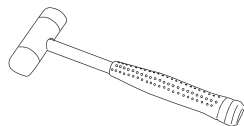

Martillo de bocas de nylon **236**

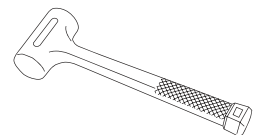

Maza antirrebote **237**

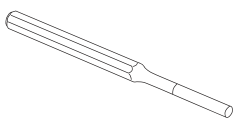

Botador y granete **238**

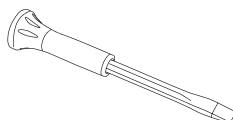

Cinzel y puntero **239**

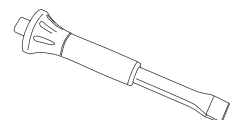

Cortafrió y buril **241**



MARTILLO DE BOLA, MANGO DE GRAFITO

- Cabeza en Acero al Carbono forjado.
- Superficie de trabajo templada (alta dureza).
- Fijación del mango mediante resina.
- Agujero en el mango para colgar.

Cód.	grs.	A mm	L mm	P.V.P. unid. €	
196652	455	30	355	18,78	6
196654	560	32	380	20,50	6
196657	680	34	405	22,38	6
196663	910	38	405	26,26	6
196664	1360	40	405	39,41	6

MANGOS DE RECAMBIO

196653*	para 196652, 196654	7,31	6
196658*	para 196657, 196663, 196664	8,53	6

* No se suministra resina para unir el mango con la cabeza.



COMPARATIVA GRAFITO-FIBRA DE VIDRIO

MÁS LIGERO. Peso aproximado 20% menor.
MÁS RESISTENTE. Resistencia a los impactos 30% mayor.
ANTI-VIBRACIÓN. Absorbe mucho mejor la vibración del golpe y la transmite en menor grado al brazo. Más ergonómico y menor fatiga.



Mangos



MARTILLO DE BOLA, MANGO DE FIBRA DE VIDRIO

- Cabeza en Acero al Carbono forjado.
- Superficie de trabajo templada (alta dureza).
- Fijación del mango mediante resina.
- Mango de fibra de vidrio en forma ergonómica.

Cód.	grs.	A mm	L mm	P.V.P. unid. €	
186318	360	28	305	11,57	6
186320	455	30	345	14,01	6
186324	680	34	345	16,45	6
186326	910	38	345	19,49	6
186327	1360	38	415	22,90	6

MANGOS DE RECAMBIO

186319*	para 186318	5,48	6
186321*	para 186320, 186324, 186326	6,21	6
186329*	para 186327	7,31	6

* No se suministra resina para unir el mango con la cabeza.



Mangos



MARTILLO DE BOLA, MANGO DE HICKORY

- Cabeza en Acero al Carbono forjado.
- Superficie de trabajo templada (alta dureza).
- Fijación del mango por cuña metálica y resina.
- Mango de Hickory.

Cód.	grs.	A mm	L mm	P.V.P. unid. €	
196548	360	28	345	12,18	6
196550	455	30	355	14,62	6
196554	520	32	380	15,47	6
196555	680	34	405	17,66	6
196560	910	38	405	21,32	6
196562	1360	40	405	26,80	6

MANGOS DE RECAMBIO

196551*	para 196548, 196550, 196554	6,70	6
196556*	para 196555, 196560	7,31	6
196563*	para 196562	7,80	6

* No se suministra resina para unir el mango con la cabeza.



Mangos



MARTILLO DE BOLA, MANGO DE FIBRA DE VIDRIO



Cód.	grs.	A mm	L mm	P.V.P. unid. €	
170150	450	30	325	9,83	6
170152	680	34	345	10,65	6
170154	910	38	365	12,55	6
MANGOS DE RECAMBIO					
170156*	para 170150			3,59	6
170157*	para 170152			3,59	6
170158*	para 170154			3,59	6



- Cabeza en Acero de carbono forjado.
- Superficie de trabajo templada.
- Fijación del mango mediante resina.
- Mango ergonómico de fibra de vidrio.

* No se suministra resina para unir el mango con la cabeza.



MARTILLO DE PEÑA, MANGO DE GRAFITO

Cód.	grs.	A mm	L mm	P.V.P. unid. €	
196612	80	16	310	15,32	6
196617	135	20	310	16,40	6
196622	180	22	310	17,58	6
196628	320	25	310	18,89	6
196632	420	30	310	19,43	6
MANGOS DE RECAMBIO					
196613*	para 196612, 196617			8,53	6
196629*	para 196622, 196628, 196632			9,14	6



- Cabeza en Acero al Carbono forjado.
- Superficie de trabajo templada (alta dureza).
- Fijación del mango por resina.
- Mango de grafito en forma ergonómica.

* No se suministra resina para unir el mango con la cabeza.



MARTILLO DE PEÑA, MANGO FIBRA DE VIDRIO

Cód.	grs.	A mm	L mm	P.V.P. unid. €	
186308	135	20	280	9,99	6
186310	180	22	280	11,09	6
186312	320	25	310	12,30	6
186314	420	30	340	13,64	6
MANGOS DE RECAMBIO					
186309*	para 186308, 186310			4,26	6
186313*	para 186312			4,99	6
186315*	para 186314			5,24	6

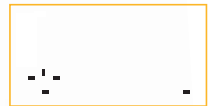

- Cabeza en Acero al Carbono forjado.
- Superficie de trabajo templada (alta dureza).
- Fijación del mango por resina.
- Mango de fibra de vidrio en forma ergonómica.

* No se suministra resina para unir el mango con la cabeza.



MARTILLO DE PEÑA, MANGO DE HICKORY

Cód.	grs.	A mm	L mm	P.V.P. unid. €	
196510	100	18	280	8,39	6
196515	135	20	280	8,67	6
196520	180	22	280	9,44	6
196523	320	25	280	9,78	6
196524	420	30	280	11,66	6
MANGOS DE RECAMBIO					
196511*	para 196510			3,86	6
196516*	para 196515, 196520			3,96	6
196522*	para 196523			4,13	6
196527*	para 196524			4,52	6



- Cabeza en Acero al Carbono forjado.
- Superficie de trabajo templada (alta dureza).
- Fijación de mango por resina y cuña metálica.
- Mango de Hickory.

* No se suministra resina para unir el mango con la cabeza.



MARTILLO DE BOLA, MANGO DE FIBRA DE VIDRIO



- Cabeza en Acero de carbono forjado.
- Superficie de trabajo templada.
- Fijación del mango mediante resina.

Cód.	grs.	A mm	L mm	P.V.P. unid. €	
170160	135	20	270	6,71	6
170165	320	25	290	7,31	6
170167	420	30	340	8,14	6



* No hay mangos de recambio disponibles para este martillo.
 * No se suministra resina para unir el mango con la cabeza.



MARTILLO DE AJUSTADOR, MANGO FIBRA DE VIDRIO

- Cabeza en Acero al Carbono forjado.
- Superficie de trabajo templada (alta dureza).
- Fijación del mango por resina.
- Mango de fibra de vidrio en forma ergonómica.

Cód.	grs.	A mm	L mm	P.V.P. unid. €	
186328	300	22	310	12,06	6
186330	500	26	340	13,28	4
MANGOS DE RECAMBIO					
186313*	para 186328			4,99	6
186315*	para 186330			5,24	6

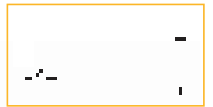

Mangos

* No se suministra resina para unir el mango con la cabeza.



MACETA DE ALBAÑIL, MANGO DE GRAFITO

- Cabeza fabricada en Acero al Carbono forjado.
- Superficie de trabajo templada (alta dureza).
- Mango cónico de grafito.

Cód.	kgs.	L mm	P.V.P. unid. €	
196605	1	290	22,74	4
196608	1,25	290	26,80	4
MANGOS DE RECAMBIO				
196606	para 196605, 196608		11,45	6



Mangos



MACETA DE ALBAÑIL, MANGO DE FIBRA DE VIDRIO

- Cabeza fabricada en Acero al Carbono forjado.
- Superficie de trabajo templada (alta dureza).
- Fijación del mango por resina.
- Mango de fibra de vidrio en forma ergonómica.

Cód.	kgs.	L mm	P.V.P. unid. €	
196600	1	280	15,59	6
196602	1,5	280	17,97	6
MANGOS DE RECAMBIO				
196601*	para 196600, 196602		5,48	6





Mangos

* No se suministra resina para unir el mango con la cabeza.



MACETA DE ALBAÑIL, MANGO DE HICKORY

- Cabeza fabricada en Acero al Carbono forjado.
- Superficie de trabajo templada (alta dureza).
- Fijación del mango por resina y cuña metálica.

Cód.	 kgs.	L mm	P.V.P. unid. €	
196500	1	260	12,79	6
196502	1,4	280	15,63	4
MANGOS DE RECAMBIO				
196501*	para 196500		3,29	6
196518*	para 196502		3,78	6

* No se suministra resina para unir el mango con la cabeza.





Mangos



MACETA DE ALBAÑIL, MANGO FIBRA DE VIDRIO

- Cabeza en Acero de carbono forjado.
- Superficie de trabajo templada.
- Fijación del mango mediante ojo cónico.

Cód.	 kgs.	L mm	P.V.P. unid. €	
170170	1	280	11,87	6
170172	1,5	280	14,58	6
MANGOS DE RECAMBIO				
170171	para 170170, 170172		3,80	6



Mangos





08



MACETA CUADRADA, MANGO DE FIBRA DE VIDRIO

- Fijación del mango mediante resina.

Cód.	 kgs.	L mm	P.V.P. unid. €	
186200	1	280	14,99	6
186202	1,5	280	16,87	6
186204	2	280	18,58	6
MANGOS DE RECAMBIO				
196601*	para 186200, 186202, 186204		5,48	6





Mangos

* No se suministra resina para unir el mango con la cabeza.



MACETA CUADRADA, MANGO DE HICKORY

- Fijación del mango mediante cuña metálica y resina.

Cód.	 kgs.	L mm	P.V.P. unid. €	
186300	1	260	13,10	6
186302	1,5	280	15,73	6
186304	2	280	17,45	6
MANGOS DE RECAMBIO				
196501*	para 186300		3,29	6
196518*	para 186302, 186304		3,78	6



Mangos

* No se suministra resina para unir el mango con la cabeza.





MARTILLO DE UÑA CURVA, MANGO DE FIBRA DE VIDRIO

- Cabeza fabricada en Acero al Carbono forjada.
- Superficie de trabajo templada (alta dureza).
- Mango cónico de fibra de vidrio.

Cód.	grs.	L mm	P.V.P. unid. €	
196665	400	330	14,36	6
196670	600	330	16,01	6
MANGOS DE RECAMBIO				
196666	para 196665, 196670		4,87	6



Mangos



MARTILLO DE UÑA CURVA, MANGO DE MADERA

Cód.	grs.	L mm	P.V.P. unid. €	
196565	400	330	11,84	6
196570	600	330	13,39	6
196575	800	390	15,19	6
MANGOS DE RECAMBIO				
196566	para 196565, 196570		3,05	6
196576	196575		3,85	6



Mangos



08



MARTILLO DE CARPINTERO, MANGO DE FIBRA DE VIDRIO

- Cabeza en Acero de carbono forjado.
- Superficie de trabajo templada.
- Fijación del mango mediante resina.

Cód.	grs.	A mm	L mm	P.V.P. unid. €	
186340	450	26	325	11,57	6
186342	560	30	345	13,28	6
MANGOS DE RECAMBIO					
186321*	para 186340, 186342			6,21	6



Mangos



* No se suministra resina para unir el mango con la cabeza.



MARTILLO DE CARPINTERO, MANGO FIBRA DE VIDRIO

- Cabeza en Acero de carbono forjado.
- Superficie de trabajo templada.
- Fijación del mango mediante resina.

Cód.	grs.	A mm	L mm	P.V.P. unid. €	
170140	450	26	325	8,41	6
170142	560	30	325	9,43	6
MANGOS DE RECAMBIO					
170146*	para 170140, 170142			3,58	6



Mangos



* No se suministra resina para unir el mango con la cabeza.



MARTILLO DE CARPINTERO, MANGO FIBRA DE VIDRIO

Cód.	grs.	A mm	L mm	P.V.P. unid. €	
170145	220	22	165	6,92	6

SERIE CORTA





MARTILLO DE ENCOFRADOR, MANGO DE FIBRA DE VIDRIO



- Cabeza con imán.
- Fijación cónica.

Cód.	grs.	L mm	P.V.P. unid. €	
196690	700	500	24,36	6
MANGOS DE RECAMBIO				
196691	para 196690		6,70	6



Mangos



MARTILLO DE ENCOFRADOR, MANGO DE MADERA



- Cabeza con imán.
- Fijación cónica.

Cód.	grs.	L mm	P.V.P. unid. €	
196580	500	500	15,23	6
196590	700	500	16,20	6
MANGOS DE RECAMBIO				
196581	para 196580, 196590		3,65	6



Mangos



08



MAZA DE CANTERO, MANGO DE MADERA

- Fijación cónica

Cód.	kgs.	L mm	P.V.P. unid. €	
196503	1	250	15,47	6
MANGOS DE RECAMBIO				
196504	para 196503		3,05	6



Mangos



CUÑA METÁLICA PARA MADERA

- Cuerpo forjado de una sola pieza.
- Filo de corte pulido.
- Diseñada para una buena penetración en la madera.

Cód.	Peso kgs.	P.V.P. unid. €	
198680	2	17,05	6



250x50x36 mm

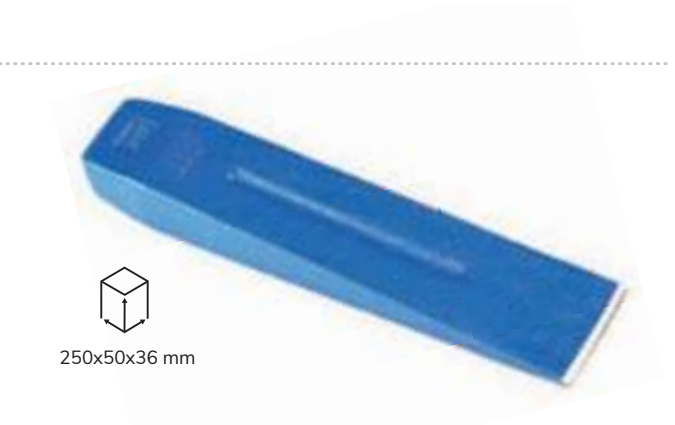



MAZA, MANGO DE FIBRA DE VIDRIO

- Cabeza fabricada en Acero al Carbono forjado.
- Superficie de trabajo templada (alta dureza).
- Fijación del mango mediante ojo cónico.

Cód.	kgs.	L mm	P.V.P. unid. €	
196625	3	900	48,06	4
196627	4	900	53,34	2
196630	5	900	58,70	2
MANGOS DE RECAMBIO				
196631	para 196625, 196627, 196630		17,31	6



Mangos



MAZA, MANGO DE MADERA

- Cabeza fabricada en Acero al Carbono forjado.
- Superficie de trabajo templada (alta dureza).
- Fijación del mango mediante ojo cónico.

Cód.	kgs.	L mm	P.V.P. unid. €	
196525	3	900	32,42	4
196530	5	900	42,45	2
MANGOS DE RECAMBIO				
196531	para 196525, 196530		9,96	6



Mangos



MAZA, MANGO DE FIBRA DE VIDRIO

- Cabeza en Acero de carbono forjado.
- Superficie de trabajo templada.
- Fijación del mango mediante ojo cónico.

Cód.	kgs.	L mm	P.V.P. unid. €	
170135	3	900	36,19	4
170137	5	900	44,94	2
MANGOS DE RECAMBIO				
170136	para 170135, 170137		12,15	6



Mangos



MAZA CUÑA, MANGO DE FIBRA DE VIDRIO

- Cabeza con filo de corte pulido reafilable.
- Fijación del mango mediante ojo cónico.

Cód.	kgs.	L mm	P.V.P. unid. €	
196633	3,5	900	63,35	4
MANGOS DE RECAMBIO				
196631	para 196633		17,31	6





Mangos



HACHA, MANGO DE FIBRA DE VIDRIO



- Filo de corte pulido reafilable.
- Fijación del mango mediante resina.
- Protección plástica del filo.

Cód.	 grs.	L mm	P.V.P. unid. €	
186348	400	280	15,23	6
186350	600	360	17,30	6
186352	800	360	20,47	6
186354	1000	425	24,97	4
186356	1250	900	38,01	4



HACHA, MANGO DE HICKORY

- Cabeza con filo de corte pulido reafilable.
- Fijación del mango mediante resina.
- Protección plástica del filo.

Cód.	 grs.	L mm	P.V.P. unid. €	
198620	500	450	22,54	6
198625	700	450	24,97	6
198630	1000	680	34,11	4
198632	1200	680	37,15	4





08



HACHA, MANGO DE FIBRA DE VIDRIO

- Cabeza en Acero de carbono forjado.
- Filo reafilable.
- Fijación del mango mediante resina.

Cód.	 grs.	L mm	P.V.P. unid. €	
171060	600	360	13,14	6
171064	1000	420	19,36	4
MANGOS DE RECAMBIO				
171061*	para 171060		4,09	6
171065*	para 171064		4,74	6



Mangos

* No se suministra resina para unir el mango con la cabeza.

**PIQUETA DE ALBAÑIL,
MANGO DE FIBRA DE VIDRIO**



196666



Cód.	grs.	L mm	P.V.P. unid. €	
196695	700	330	23,15	6
MANGOS DE RECAMBIO				
196666	para 196695		4,87	6

**PIQUETA DE ALBAÑIL,
MANGO DE MADERA**



196566



Cód.	grs.	L mm	P.V.P. unid. €	
196595	700	330	18,27	6
MANGOS DE RECAMBIO				
196566	para 196595		3,05	6

**ALCOTANA PALA-HACHA,
MANGO DE FIBRA DE VIDRIO**



196666



Cód.	grs.	L mm	P.V.P. unid. €	
198750	550	330	19,49	6
198755	650	330	20,71	6
MANGOS DE RECAMBIO				
196666	para 198750, 198755		4,87	6

**ALCOTANA PALA-HACHA,
MANGO DE MADERA**



196566



Cód.	grs.	L mm	P.V.P. unid. €	
198650	550	330	15,84	6
198655	650	330	17,66	6
MANGOS DE RECAMBIO				
196566	para 198650, 198655		3,05	6

**ALCOTANA PALA-PICO,
MANGO DE FIBRA DE VIDRIO**



196666



Cód.	grs.	L mm	P.V.P. unid. €	
198758	400	330	18,27	6
198760	650	330	19,49	6
MANGOS DE RECAMBIO				
196666	para 198758, 198760		4,87	6

**ALCOTANA PALA-PICO,
MANGO DE MADERA**



196566



Cód.	grs.	L mm	P.V.P. unid. €	
198658	400	330	15,23	6
198660	650	330	16,45	6
MANGOS DE RECAMBIO				
196566	para 198658, 198660		3,05	6

08



PIQUETA DE SOLDADOR

- Puntas de pico y hacha verticales.
- Mango tubular metálico.
- Empuñadura bimatérica ergonómica.

ESPECIAL SOLDADURA

Cód.	grs.	L mm	P.V.P. unid. €	
198748	400	300	10,48	6



PICO

- Acero al carbono. Cuerpo forjado.
- Puntas pulidas. Ojo cónico.

Cód.	kgs.	L mm	P.V.P. unid. €	
198668	2	550	18,88	6
198670	2,5	580	20,71	6
198675	3	580	23,75	6

Se suministra sin mango.



Mangos acoplables
198676 / 198776.

08



MANGOS PARA PICOS

- Mango ergonómico.
- Para fijación cónica.



198676



198776

Cód.	Tipo	Ø x L mm	P.V.P. unid. €	
198676	Madera	38 x 900	10,48	6
198776	Fibra	38 x 900	20,71	6



MACETA DE COBRE ANTICHISPA

- Cabeza fabricada en cobre.
- Mango de madera barnizado.
- Fijación cónica.

Cód.	grs.	Medidas mm	P.V.P. unid. €	
196760	500	25x80x300	67,82	1
196762	1000	32x100x300	96,24	1
196764	1500	38x120x360	134,75	1
196766	2000	40x135x400	167,34	1
196768	4000	64x140x900	331,34	1



196760



Empleo en siderurgia, minería, petroquímicas y lugares con riesgo de deflagración.



MARTILLO DE BOCAS DE NYLON, MANGO METÁLICO

- Cuerpo fabricado en hierro pavonado.
- Bocas de nylon tratadas insertadas a presión en el cuerpo metálico.
- Mango ergonómico antideslizante de goma.

Cód.	A Ø mm	grs.	P.V.P. unid. €	
196805	28	300	20,52	6
196810	34	600	25,68	6
196815	44	1100	35,35	6



MARTILLO DE BOCAS DE NYLON, MANGO MADERA

- Mango de madera unido al cuerpo del martillo mediante pasador metálico.
- Mango de madera de alta calidad barnizado.

Cód.	A Ø mm	grs.	P.V.P. unid. €	
196705	28	300	13,89	6
196710	34	550	17,66	6
196715	44	1050	25,98	6
196720	54	1100	46,28	6



08



BOCAS DE NYLON DE RECAMBIO

Cód.	Ø mm	P.V.P. unid. €	
196701	28	2,52	10
196702	34	3,03	10
196703	44	4,04	10
196704	54	7,31	6

INSTRUCCIONES DE USO

Colocación de las bocas orientando el agujero hacia el cuerpo del martillo y golpeándolas para su inserción por impacto.

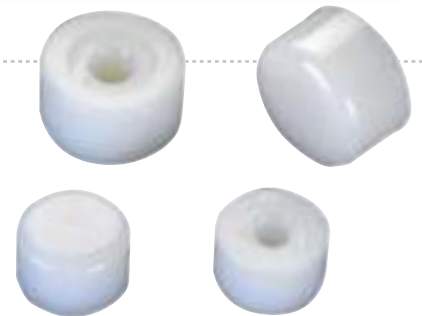

MARTILLO DE BOCAS DE NYLON ANTIRREBOTE

- Cuerpo de hierro zincado.
- Bocas de nylon tratadas insertadas a presión.

Cód.	Ø mm	grs.	P.V.P. unid. €	
196725	35	500	30,45	6
196730	50	1100	44,86	6
BOCAS DE RECAMBIO				
196727	para 196725		3,14	10
196732	para 196730		4,62	6



Bocas

Bocas antirrebote



MARTILLO DE BOCAS DE PVC, MANGO DE MADERA

- Bocas de PVC intercambiables.
- Bocas fijadas a rosca.

Cód.	A Ø mm	L mm	P.V.P. unid. €	
170176	35	300	10,74	6
170178	40	300	11,77	6
BOCAS DE RECAMBIO				
170177	para 170176		1,22	10
170179	para 170178		1,60	10





Bocas



 MAZA DE GOMA NEGRA,
MANGO FIBRA DE VIDRIO

- Cabeza de caucho duro.





Cód.	 grs.	Ø mm	L mm	P.V.P. unid. €	
196781	455	60	340	10,96	6
196784	685	65	360	11,57	6

 MAZA DE GOMA BLANCA,
MANGO FIBRA DE VIDRIO

- No mancha al golpear.





Cód.	 grs.	Ø mm	L mm	P.V.P. unid. €	
196787	455	60	340	12,73	6

 MAZA DE GOMA NEGRA,
MANGO DE MADERA

- Cabeza de caucho duro.





Cód.	 grs.	Ø mm	L mm	P.V.P. unid. €	
196780	455	60	310	4,87	6
196782	685	65	336	6,70	6
196783	910	70	360	7,92	6

 MAZA DE GOMA BLANCA,
MANGO DE MADERA

- No mancha al golpear.





Cód.	 grs.	Ø mm	L mm	P.V.P. unid. €	
196785	455	60	310	9,75	6
196786	685	65	350	10,96	6

08

 MAZA DE GOMA COMBINADA,
MANGO DE MADERA

- Cabeza mixta: caucho duro/goma blanca.





Cód.	 grs.	Ø mm	L mm	P.V.P. unid. €	
196788	685	65	350	12,18	6

 MAZA ANTIRREBOTE
DE POLIURETANO

- Fabricada en Poliuretano.
- Monobloc.



Cód.	 grs.	A Ø mm	L mm	P.V.P. unid. €	
196789	455	42	300	16,02	6
196790	690	50	325	21,11	6
196792	920	56,5	337	23,73	6



BOTADOR CILÍNDRICO



■ Cuerpo hexagonal.



SERIE NORMAL



Cód.	D Ø mm	H mm	L mm	P.V.P. unid. €	
140020	2	10	150	5,19	10
140021	3	10	150	5,19	10
140022	4	10	150	5,54	10
140023	5	10	150	5,54	10
140024	6	10	150	5,54	10
140025	7	12	150	5,96	10
140026	8	12	150	5,96	10



BOTADOR CILÍNDRICO



■ Cuerpo hexagonal.



SERIE LARGA



Cód.	D Ø mm	H mm	L mm	P.V.P. unid. €	
140034	4	10	180	6,54	10
140036	6	10	180	6,54	10

08



BOTADOR CÓNICO



■ Cuerpo hexagonal.



Cód.	D Ø mm	H mm	L mm	P.V.P. unid. €	
140012	2	10	120	4,40	10
140013	3	10	120	4,40	10
140014	4	10	120	4,48	10
140015	5	10	120	4,81	10
140016	6	10	120	4,81	10



GRANETE



■ Cuerpo hexagonal.

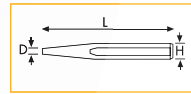

Cód.	D Ø mm	H mm	L mm	P.V.P. unid. €	
138004	3	10	100	4,48	10
138005	4	10	120	4,80	10
138006	5	12	120	5,01	10
138007	6	12	120	5,52	10
138008	8	12	120	5,68	10



GRANETE AUTOMÁTICO

- Cuerpo fabricado en acero.
- Punta fabricada en acero HSS.
- Cabeza de plástico.
- Potencia regulable.



Cód.	L mm	P.V.P. unid. €	
138021	135	14,22	6

Se suministra en blíster.



JUEGO DE BOTADORES CILÍNDRICOS

COMPOSICIÓN
2, 3, 4, 5, 6, 8 mm.

ESTUCHE PLÁSTICO



Cód.	Nº Piezas	P.V.P. unid. €	
140029	6	33,18	1

JUEGO DE BOTADORES CÓNICOS + GRANETE

COMPOSICIÓN

5 botadores cónicos 2, 3, 4, 5, 6 mm.
1 granete 4 mm.

ESTUCHE PLÁSTICO



Cód.	Nº Piezas	P.V.P. unid. €	
140019	6	27,25	1

JUEGO DE BOTADORES Y CINCELES

COMPOSICIÓN

1 Cíncel 12x10x150 mm.
1 Buril 4x10x130 mm.
1 Granete 5 mm.
1 Botador Cilíndrico 5 mm.
2 Botadores cónicos de 3 y 4 mm.

ESTUCHE PLÁSTICO



Cód.	Nº Piezas	P.V.P. unid. €	
140050	6	35,94	1

CINCEL CON PROTECTOR

ACERO CR-SI-MO

- Se suministra con el protector ya montado en el cíncel.
- Protector suelto disponible en la parte inferior de esta página.



Zona de trabajo templada por inducción a 55 HRC. Punta pulida reafilable.



Cód.	L mm	B x A mm	P.V.P. unid. €	
196956	250	16x23	13,40	6
196961	300	16x23	14,01	6
196966	350	18x26	15,23	6
196971	400	18x26	17,66	6

Zona del ala en plástico de alta resistencia para una mejor protección de la mano.

Protector ergonómico adaptado a la forma de la mano.

Cuerpo con forma octogonal.

Zona de golpeo templada a 40 HRC.

Zona de contacto con la mano en goma antideslizante. Zona rayada para una mejor sujeción.

08

PUNTERO CON PROTECTOR

ACERO CR-SI-MO

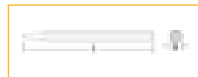

Cód.	L mm	B x A mm	P.V.P. unid. €	
196911	250	16x23	12,79	6
196916	300	16x23	14,62	6
196921	350	18x26	17,05	6
196926	400	18x26	19,49	6

Cabeza pulida reafilable.



PROTECTOR BIMATERIAL

- 196975: para cínceles y punteros de Ø 16 mm.
- 196977: para cínceles y punteros de Ø 18 mm.

Cód.	L mm	Ø exterior mm	P.V.P. unid. €	
196975	150	26	5,63	6
196977	150	32	5,63	6





CINCEL EXTRA FUERTE

**ACERO
CR-SI-MO**

**CUERPO OCTOGONAL
EXTRAFUERTE**

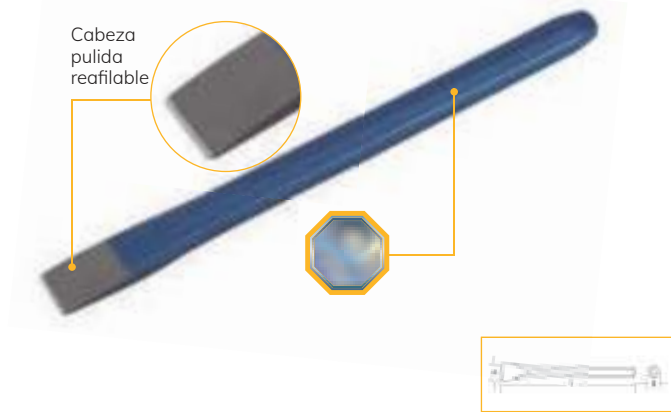

Cód.	L mm	B x A mm	P.V.P. unid. €	
196952	200	18x20	10,96	6
196957	250	20x23	14,01	6
196962	300	20x23	15,59	6

Se suministra con colgador.



CINCEL

**ACERO
CR-SI-MO**

- Cuerpo octogonal.
- Zona de trabajo templada a 55 HRC.

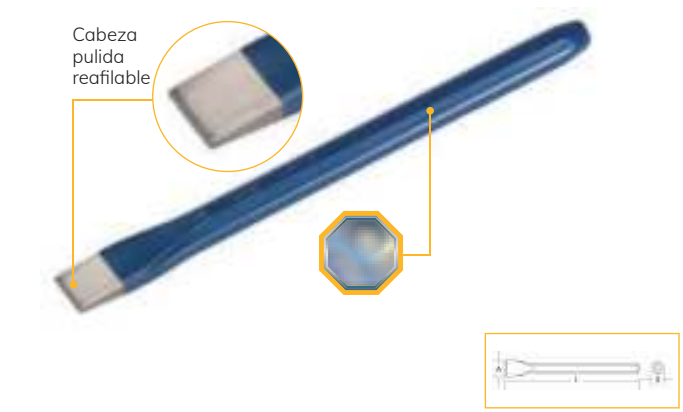

Cód.	L mm	B x A mm	P.V.P. unid. €	
196950	200	16x23	7,19	6
196955	250	16x23	7,85	6
196960	300	16x23	8,53	6
196965	350	18x26	11,29	6
196970	400	18x26	12,18	6

Se suministra con colgador.



PUNTERO

**ACERO
CR-SI-MO**

- Cuerpo octogonal.
- Zona de trabajo templada a 55 HRC.

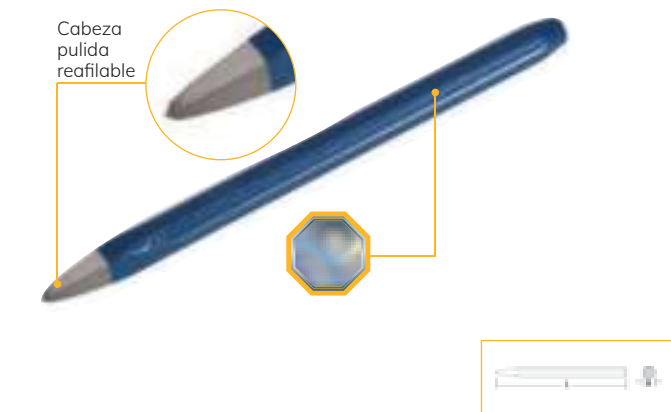

Cód.	L mm	B x A mm	P.V.P. unid. €	
196905	200	14x20	6,37	6
196910	250	16x23	7,20	6
196915	300	16x23	7,95	6
196920	350	18x26	10,35	6
196925	400	18x26	11,21	6

Se suministra con colgador.



CINCEL PARA ELECTRICISTA

**ACERO
CR-SI-MO**

- Cuerpo octogonal.
- Zona de trabajo templada a 55 HRC.



Cód.	L mm	B x A mm	P.V.P. unid. €	
196930	200	10x12	6,09	6
196935	250	10x12	6,70	6
196940	300	10x12	7,31	6



CORTAFRÍOS CON PROTECTOR

ACERO
CR-SI-MO

- Se suministra con el protector ya montado en el cortafríos.
- Protector suelto disponible en la pág. 242.

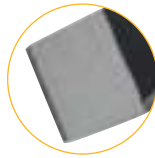

Zona de trabajo templada por inducción a 55 HRC. Punta pulida y reafilable.



Cuerpo con forma rectangular (23x13).



Zona del ala en plástico de alta resistencia para mejor protección de la mano.

Zona de golpeo templada a 40 HRC.

Protector ergonómico que se adapta a la forma de la mano.

Zona de contacto con la mano en goma antideslizante. Zona rayada para una mejor sujeción.

Presentación del cuerpo pintado.

Cód.	L mm	AxBxH mm	P.V.P. unid. €	
197456	250	26x23x13	15,47	6
197471	300	30x23x13	18,72	6
197473	350	30x23x13	19,49	6
197475	400	30x23x13	21,32	6



CORTAFRÍOS

ACERO
CR-SI-MO

- Cuerpo rectangular 23x13 mm.
- Filo de corte templado reafilable.



Cód.	L mm	AxBxH mm	P.V.P. unid. €	
197450	200	24x23x13	12,18	6
197455	250	26x23x13	12,79	6
197470	300	30x23x13	14,99	6
197472	350	30x23x13	16,19	6
197474	400	30x23x13	20,10	6



08



CORTAFRÍOS CON PROTECTOR

- Cuerpo rectangular 23x13 mm.
- Filo de corte templado reafilable.



Cód.	L mm	AxBxH mm	P.V.P. unid. €	
171151	250	26x23x13	10,92	6
171153	300	30x23x13	12,19	6



CORTAFRÍOS

- Cuerpo rectangular 23x13 mm.
- Filo de corte templado reafilable.



Cód.	L mm	AxBxH mm	P.V.P. unid. €	
171150	250	26x23x13	7,88	6
171152	300	30x23x13	9,21	6
171155	400	30x23x13	10,82	6



Se suministra con colgador.



CINCEL PARA RANURAS

ACERO CR-SI-MO

- Puntas pulidas reafilables.
- Presentación pintado.



Cód.	L mm	AxBxH mm	P.V.P. unid. €	
197460	250	50x23x13	18,27	6
197465	250	70x23x13	22,32	6



CINCEL PARA RANURAS CON PROTECTOR

ACERO CR-SI-MO

- Puntas pulidas reafilables.
- Presentación pintado.



Cód.	L mm	AxBxH mm	P.V.P. unid. €	
197461	250	50x23x13	22,29	6
197466	250	70x23x13	25,22	6



ESCARPA PLANA

ACERO CR-SI-MO

- Puntas pulidas reafilables.
- Presentación pintado.



Cód.	L mm	BxH mm	P.V.P. unid. €	
197480	240	25x7	12,18	6



ESCARPA PLANA CON PROTECTOR

ACERO CR-SI-MO

- Puntas pulidas reafilables.
- Presentación pintado.

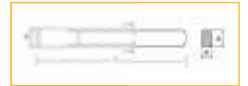

Cód.	L mm	BxH mm	P.V.P. unid. €	
197481	240	25x7	14,98	6



BURIL

ACERO CR-SI-MO

- Puntas pulidas reafilables.
- Presentación pintado.



Cód.	L mm	BxH mm	P.V.P. unid. €	
197001	200	23x13	12,26	6
197003	250	23x13	14,01	6



PROTECTOR BIMATERIAI

- Para cortafíos, cincelos para ranuras y buriles.

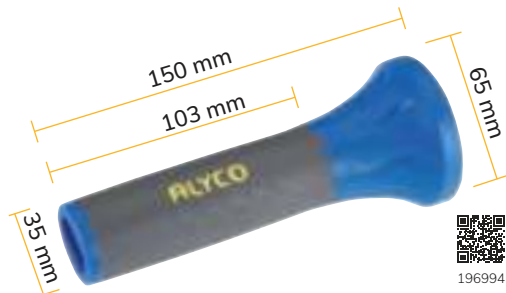

Cód.	L mm	Para	P.V.P. unid. €	
196994	150	Todos los Cód. excepto 197480	4,97	6
196989	130	197480	4,52	6

09

CORTE Y TALADRADO

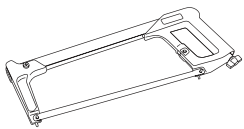

Arco de Sierra **244**

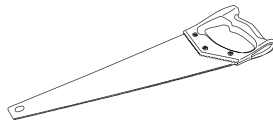

Serrucho **246**

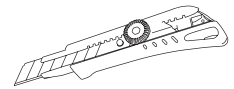

Cutter de cuchillas **249**

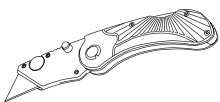

Cutter de aluminio **250**

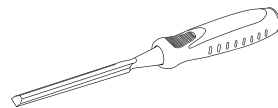

Formón **252**

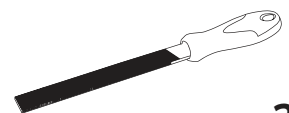

Lima **253**



Escofina **256**



Barreno **257**



Cepillo metálico **258**



Cepillo manual **261**



Corona perforadora **263**



Broca para metal **264**



Juego de machos y cojinetes **265**



Broca para hormigón **266**



Broca plana **268**



ARCO DE SIERRA REFORZADO

- Cuerpo de Aluminio.
- Amarre y regulación mediante palanca.
- Mango recubierto de elastómero antideslizante.
- Posibilidad de amarre de la hoja a 45° ó 90°.
- Almacén de hojas de sierra en el cuerpo.

**HOJA BIMETÁLICA DE 300 MM.
CAPACIDAD DE TENSIÓN
2000 Kg /cm²**



Incluye hoja de sierra para madera y plástico de 6 dpp

Cód.	L mm	L "	P.V.P. unid. €	
144093	400	16	24,13	6



ARCO DE SIERRA, CUERPO DE ALUMINIO

- Cuerpo de Aluminio.
- Amarre y regulación mediante mariposa.
- Posibilidad de amarre de la hoja a 45° ó 90°.
- Posibilidad de amarre de la hoja en voladizo.
- Almacén de hojas de sierra en el cuerpo.

**HOJA BIMETÁLICA
DE 300 MM.**



09

Cód.	L mm	L "	P.V.P. unid. €	
144004	400	16	15,40	6



ARCO DE SIERRA, CUERPO DE ALUMINIO

- Cuerpo de Aluminio con tubo de acero.
- Ajuste de tensión regulable en mango.
- Posibilidad de trabajo a 45° y 90°.
- Almacén de hojas de sierra en cuerpo.

**HOJA EN ACERO
AL CARBONO.**



Cód.	L mm	L "	P.V.P. unid. €	
170838	390	16	11,81	6



ARCO DE SIERRA

- Cuerpo en Acero.
- Mangos en Aluminio y zona de contacto con la mano en goma blanda antideslizante.
- Hoja de sierra en Acero al carbono.

**HOJA EN ACERO
AL CARBONO.**



Cód.	L mm	L "	P.V.P. unid. €	
170840	430	17	9,09	6



MINI ARCO DE SIERRA

- Cuerpo de Aluminio.
- Hoja de sierra bimetálica.
- Con ruleta moleteada para bloqueo de la hoja.
- Posibilidad de regular la apertura de la hoja.

Cód.	L mm	L "	P.V.P. unid. €	
144000	230	9	8,72	12

INCLUYE:
+1
Hoja 24
dientes/pulg.



Se suministra en blíster.



MINI ARCO DE SIERRA

- Cuerpo metálico.
- Hoja de 24 dientes y 300 mm (170810).

Cód.	L mm	L "	P.V.P. unid. €	
170836	320	13	6,45	6



ARCO DE SIERRA JUNIOR

- Cuerpo de Acero.
- Mango bimaterial en plástico duro ABS y goma antideslizante TPR.
- Hoja de sierra de Acero al Carbono de 24 dpp.

HOJA DE
150 MM

Cód.	L mm	L "	P.V.P. unid. €	
144035	225	9	8,72	6

INCLUYE:
+2 Hojas

HOJAS DE RECAMBIO

144036	Envase 10 unidades	6,39	1
---------------	--------------------	-------------	---



Hojas unidad de venta envase de 10 unidades.



09

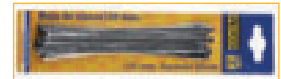

HOJA DE SIERRA BIMETÁLICA

- Hoja fabricada en Acero aleado de alta flexibilidad.
- Filo corte dentado HSS soldado al cuerpo de la hoja.
- Temple total entre 63-67 HRC.

UTILIZACIÓN:

- Metal.
- Madera.
- Plástico.

Cód.	Nº dientes	P.V.P. unid. €	
197260	24	2,16	100

Se suministra en expositor de 100 unidades.

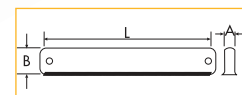

300x13x0,65 mm



HOJA DE SIERRA EN ACERO AL CARBONO

Cód.	Nº dientes	P.V.P. unid. €	
170810	24	6,91	10

Precio por cada blíster de 12 unidades.

UTILIZACIÓN:

- Metal.
- Madera.
- Plástico.



300x13x0,65 mm





SERRUCHO

- Hoja de Acero.
- Filo de corte templado.
- Mango ergonómico.



DENTADO ESTÁNDAR

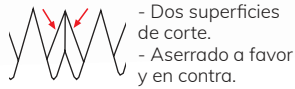

Cód.	L mm	L "	P.V.P. unid. €	
144055	400	16	12,18	6
144065	450	18	13,03	6
144075	550	22	15,12	6



SERRUCHO



- Hoja de Acero.
- Filo de corte templado.
- Mango ergonómico.



DENTADO ESTÁNDAR

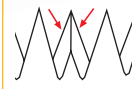

Cód.	L mm	L "	P.V.P. unid. €	
170842	300	12	7,78	6
170843	400	16	8,97	6
170845	450	18	10,06	6
170846	550	22	11,78	6



SERRUCHO DE EBANISTA

09



DENTADO ESTÁNDAR

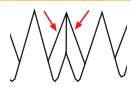

Cód.	L mm	L "	P.V.P. unid. €	
144086	250	10	8,61	10



SERRUCHO PARA PVC

- Hoja fabricada en Acero.
- Filo de corte templado.
- En punta para penetración en yeso.
- Mango reforzado bimaternal.



UTILIZACIÓN

- Plástico.
- Placas de yeso.
- Revestimientos y contrachapados de madera.

DENTADO ESTÁNDAR

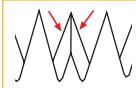

Cód.	L mm	L "	P.V.P. unid. €	
144087	250	10	11,44	10



SERRUCHO DE COSTILLA



DENTADO ESTÁNDAR

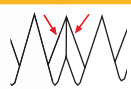

Cód.	L mm	L "	P.V.P. unid. €	
144088	300	12	10,96	10



CAJA DE INGLETEAR DE PLÁSTICO

- Fabricado en plástico duro ABS.

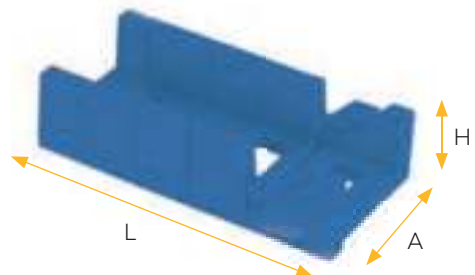

Cód.	L mm	A mm	H mm	P.V.P. unid. €	
144040	300	80	60	6,44	1
144045	300	140	60	9,12	1

CONJUNTO SERRUCHO DE COSTILLA Y CAJA DE INGLETEAR



Cód.	P.V.P. unid. €	
144046	18,76	1



SERRUCHO DE CALAR

- Filo de corte templado.
- Longitud de hoja: 325 mm.



Cód.	L mm	L "	P.V.P. unid. €	
144099	470	18,5	11,05	6

CUCHILLO DE SIERRA, MANGO RECTO

- Hoja de Acero templado.
- Mango ergonómico recto.
- Longitud de hoja: 160 mm.



Cód.	L mm	L "	P.V.P. unid. €	
144098	300	12	9,88	6

CUCHILLO DE SIERRA, MANGO CURVO

- Hoja de Acero templado.
- Mango ergonómico curvo.
- Longitud de hoja: 160 mm.



Cód.	L mm	L "	P.V.P. unid. €	
170848	300	12	7,40	6

09

ARCO DE TRONZAR

Cód.	L mm	L "	P.V.P. unid. €	
144020	525	21	12,29	6
144025	600	24	12,40	6
144030	750	30	13,98	6



HOJA DE TRONZAR, DENTADO ESTÁNDAR

- Fabricada en Acero al Carbono.



PARA MADERA SECA

Cód.	L mm	L "	P.V.P. unid. €	
144021	525	21	2,54	10
144026	600	24	2,73	10
144031	750	30	2,80	10

HOJA DE TRONZAR, DENTADO AMERICANO

- Fabricada en Acero al Carbono.



PARA MADERA VERDE

Cód.	L mm	L "	P.V.P. unid. €	
144022	525	21	2,19	10
144027	600	24	2,53	10
144032	750	30	2,75	10

CARACTERÍSTICAS CUCHILLAS

CERÁMICA	ANTI CORROSIÓN	VIDA ÚTIL x40	ALIMENTACIÓN	RECOMENDADO PARA: ■ Ambientes ácidos, agua salada, corrosión y presencia de alimentos. ■ Resistente a la abrasión, no reacciona con los alimentos y evita olores.
ACERO SK2H	PRECISIÓN DE CORTE	x5	VIDA ÚTIL x3	
ACERO SK2	PRECISIÓN DE CORTE	x1,3	VIDA ÚTIL x2	

Comparación en vida útil y precisión corte con cuchillas de acero SK5.

RECAMBIOS DE CUTTER

Cód.	Dispensador	Cuchilla	Material	Para Cutter	P.V.P unid. €	📦
186640			SK2H	170805 / 170818 / 186665	2,93	10
186642			SK2	170805 / 170818 / 186665	1,61	10
186645			SK2H	170805 / 170818 / 186650 / 186665	4,21	10
186652			SK2	170805 / 170818 / 186650 / 186665	1,64	10
186612			SK2H	170808 / 170812 / 186609 / 186610 / 195630	2,72	10
186632			SK2H	170809 / 170814 / 186615 / 186616 / 186618 / 186619 / 195625	3,22	10
186630			SK2	170809 / 170814 / 186615 / 186616 / 186618 / 186619 / 195625	1,66	10
186635			CERÁMICA	170809 / 170814 / 186615 / 186616 / 186618 / 186619 / 195625	20,96	10
186626			SK2H	186625	5,75	10
170803			SK5	170802	3,33	24

Todos los dispensadores incluyen 10 cuchillas, excepto cód. 170803 que incluye 3 cuchillas.

CUTTER REFORZADO 18 MM

CUCHILLAS UTILIZABLES

186632/186630/186635.
Ver tabla de la parte superior de la hoja.

Cód.	P.V.P. unid. €	📦
186615	6,76	10

Se suministra en blíster.

160x90x20 mm
120 grs.

Cuchilla fragmentable con 8 filos de corte aprovechables.



CUTTER DE SEGURIDAD 18 MM

CUCHILLAS UTILIZABLES

186632/186630/186635
Ver tabla de la parte superior de la hoja.

Cód.	P.V.P. unid. €	📦
186616	5,99	10

Se suministra en blíster.



La cuchilla se retrae si no está presionada, evitando cortes accidentales.

190x45x22 mm
85 grs.

Cuchilla fragmentable con 8 filos de corte aprovechables.

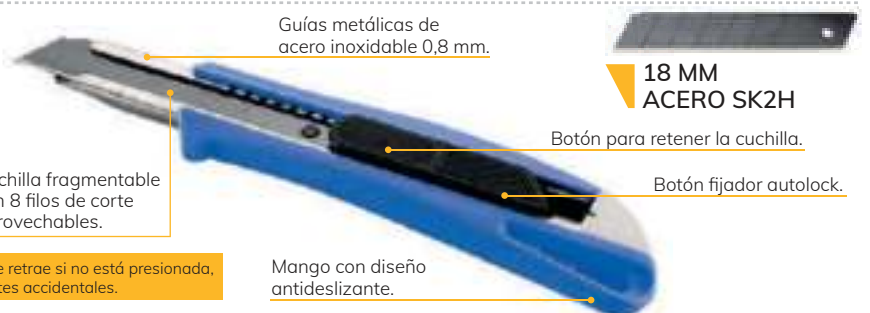

**CUTTER 18 MM
CON BOTÓN FIJADOR**

- Guía metálica en acero inox. de 0,8 mm.
- Mango de plástico ABS recubierto de goma TPR rígido y antideslizante.
- Almacén para dos cuchillas.

CUCHILLAS UTILIZABLES

186630 / 186632 / 186635
Ver tabla página anterior.

160x45x20 mm
65 grs.



Cód.	P.V.P. unid. €	
186618	4,03	10

**18 MM
ACERO SK2H**

Se suministra en blíster.

**CUTTER 18 MM
CON RULETA DE SEGURIDAD**

- Guía metálica en acero inox. de 0,8 mm.
- Mango de plástico ABS recubierto de goma TPR rígido y antideslizante.
- Almacén para dos cuchillas.

CUCHILLAS UTILIZABLES

186630 / 186632 / 186635
Ver tabla página anterior.

160x45x20 mm
65 grs.



Cód.	P.V.P. unid. €	
186619	4,06	10

**18 MM
ACERO SK2H**

Se suministra en blíster.

CUTTER 9 MM

- Guía metálica en acero inox. de 0,8 mm.
- Mango de plástico ABS recubierto de goma TPR rígido y antideslizante.

CUCHILLAS UTILIZABLES

186612
Ver tabla página anterior.

145x20x15 mm
20 grs.



Cód.	P.V.P. unid. €	
186609	2,56	10

**9 MM
ACERO SK2H**

Se suministra en blíster.

**CUTTER 18 MM + DISPENSADOR,
EN BOLSA DE NYLON**

COMPOSICIÓN

- Cutter 18 mm 186618.
- Dispensador 10 cuchillas 186632.
- Bolsa de nylon.

190x70x50 mm
180 grs.



Cód.	Nº Piezas	P.V.P. unid. €	
186622	3	13,22	6

**18 MM
ACERO SK2H**

+10

Se suministra en blíster.

**CUTTER 25 MM
CON RULETA DE SEGURIDAD**

- Guía metálica en acero inox. de 1 mm.
- Mango de plástico ABS recubierto de goma TPR rígido y antideslizante.
- Almacén para dos cuchillas.

CUCHILLAS UTILIZABLES

186626
Ver tabla página anterior.

175x40x35 mm
125 grs.



Cód.	P.V.P. unid. €	
186625	5,45	10

**25 MM
ACERO SK2H**

Se suministra en blíster.

CUTTER 9 MM EXTRAFINO

- Guía metálica en acero inox. de 0,8 mm.
- Mango de plástico ABS recubierto de goma TPR rígido y antideslizante.

CUCHILLAS UTILIZABLES

186612
Ver tabla página anterior.

150x13x13 mm
18 grs.



Cód.	P.V.P. unid. €	
186610	2,74	10

**9 MM
ACERO SK2H**

Se suministra en blíster.



CUTTER ABATIBLE DE ALUMINIO

- Cuchilla en acero SK2H con protector de plástico.
- Cuerpo de aluminio.
- Botón de cambio rápido de la cuchilla.
- Mango de aluminio anodizado ergonómico.

CUCHILLAS UTILIZABLES

186640 / 186642
186645 / 186652
Ver tabla página 248.



Incluye 3 cuchillas SK2H.



158x13x13 mm
126 grs.

Cód.	P.V.P. unid. €	
186665	13,64	6



ACERO SK2H

Se suministra en blíster.



CUTTER DE SEGURIDAD

- Guía metálica en acero inox. de 0,8 mm.
- Mango de plástico ABS

CUCHILLAS UTILIZABLES

186652 / 186645
Ver tabla página 248.



Botón de cambio de cuchilla.

Botón de bloqueo de hoja.



155x40x26 mm
75 grs.

Cód.	P.V.P. unid. €	
186650	4,65	10



ACERO SK2

Se suministra en blíster.

La cuchilla se retrae si no está presionada, evitando cortes accidentales.



CUTTER ABATIBLE

- Mango ergonómico zinc goma.

CUCHILLAS UTILIZABLES

186640 / 186642 / 186645 / 186652
Ver tabla página 248.



164x44x20,5 mm
125 grs.

Cód.	L mm cerrado	L mm abierto	P.V.P. unid. €	
170805	100	170	9,95	12

ACERO SK5

Se suministra en blíster.



CUTTER DE SEGURIDAD COMPACTO

- Cuchilla en acero SK5.
- Cuerpo de plástico ultraligero.

CUCHILLAS UTILIZABLES

186640 / 186642
186645 / 186652
Ver tabla página 248.



135x28x17 mm
32 grs.

Cód.	P.V.P. unid. €	
170818	1,29	24



ACERO SK5

Se suministra en bolsa.

La cuchilla se retrae si no está presionada, evitando cortes accidentales.



CUTTER 9 MM DE GUÍA METÁLICA

CUCHILLAS UTILIZABLES

186612. Ver tabla página 248.



Cód.	P.V.P. unid. €	
170812	2,98	12



9 MM ACERO SK5

Se suministra en bolsa.



CUTTER 18 MM DE GUÍA METÁLICA

CUCHILLAS UTILIZABLES

186630 / 186632 / 186635.
Ver tabla página 248.



Cód.	P.V.P. unid. €	
170814	3,99	12



18 MM ACERO SK5

Se suministra en bolsa.



CUTTER 9 MM DE GUÍA DE PLÁSTICO

CUCHILLAS UTILIZABLES
186612 . Ver tabla página 248.



Cód.	P.V.P. unid. €		
195630	0,57	100	9 MM ACERO SK5

Se suministra en bolsa.

CUTTER 18 MM DE GUÍA DE PLÁSTICO

CUCHILLAS UTILIZABLES
186630 / 186632 / 186635 .
Ver tabla página 248.



Cód.	P.V.P. unid. €		
195625	0,76	50	18 MM ACERO SK5

Se suministra en bolsa.

CUTTER 9 MM COMPACTO

- Guía metálica.
- Cuchilla en acero SK5.
- Cuerpo de plástico ultraligero.

CUCHILLAS UTILIZABLES
186612. Ver tabla página 248.

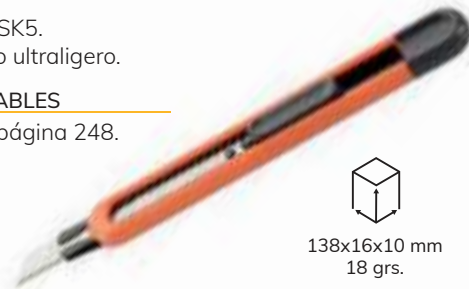

138x16x10 mm
18 grs.

Cód.	P.V.P. unid. €		
170808	1,08	24	9 MM ACERO SK5

Se suministra en bolsa.

CUTTER 18 MM COMPACTO

- Guía metálica.
- Cuchilla en acero SK5.
- Cuerpo de plástico ultraligero.

CUCHILLAS UTILIZABLES
186632 / 186630 / 186635
Ver tabla página 248.



175x28x17 mm
56 grs.

Cód.	P.V.P. unid. €		
170809	1,66	12	18 MM ACERO SK5

Se suministra en bolsa.

CUTTER ROTATIVO

- Cuchilla de acero SK5.
- Diámetro cuchilla 45 mm.



183x47x25 mm
62 grs.

Ø 45 MM
ACERO SK5

Cód.	P.V.P. unid. €	
170802	5,32	12

Se suministra en blister.

CUCHILLO DE PRECISIÓN

- Cuchilla de acero SK5.
- Cuerpo de aluminio.



146xØ8 mm
30 grs.

Cód.	P.V.P. unid. €		
170852	2,08	20	CUCHILLA ACERO SK5

Se suministra en blister.

SET DE CUCHILLOS DE PRECISIÓN

COMPOSICIÓN
1 Cuchillo precisión, m. plástico.
2 Cuchillos precisión aluminio.
13 Cuchillas recambio con diferentes tipos de puntas.



Cód.	Nº Piezas	P.V.P. unid. €		
170854	16	9,57	6	CUCHILLAS ACERO SK5

Se suministra en blister.



FORMÓN, MANGO DE PLÁSTICO

ACERO CR-V

- Superficie de la hoja rectificada.
- Refuerzo metálico para golpeo.
- Mango ergonómico.
- Se suministra con protector de filo.



Cód.	A mm	P.V.P. unid. €	
125001	6	11,44	6
125002	8	11,45	6
125003	10	11,95	6
125004	12	12,01	6
125005	14	12,07	6
125035	16	12,26	6
125007	18	13,39	6
125008	20	13,72	6
125009	22	15,14	6
125010	25	17,03	6
125011	30	17,44	6
125036	32	18,02	6
125012	35	18,25	6
125037	38	18,82	6



FORMÓN, MANGO DE MADERA

ACERO CR-V

- Superficie de la hoja rectificada.
- Refuerzo metálico para golpeo.
- Mango ergonómico.
- Se suministra con protector de filo.



Cód.	A mm	P.V.P. unid. €	
125013	6	11,61	6
125014	8	11,63	6
125015	10	12,60	6
125016	12	12,89	6
125017	14	13,57	6
125038	16	13,92	6
125019	18	14,73	6
125020	20	15,01	6
125021	22	16,72	6
125022	25	17,51	6
125023	30	19,41	6
125039	32	20,19	6
125024	35	20,53	6
125040	38	21,08	6



09

Se suministra con colgador.

Se suministra con colgador.



JUEGO DE FORMONES

COMPOSICIÓN

3 formones: 12, 20, 25 mm.

Cód.	Nº Piezas	P.V.P. unid. €	
125050	3	44,30	1
125060	3	46,51	1



125050



FORMÓN, MANGO DE PLÁSTICO

ACERO CR-V

- Hoja de acero rectificado.
- Mango bimaterial ergonómico.

Cód.	A mm	P.V.P. unid. €	
171241	10	4,88	6
171242	12	4,93	6
171244	14	5,02	6
171246	16	5,08	6
171248	18	5,18	6
171251	20	5,21	6
171252	22	5,38	6
171255	25	5,49	6



Se suministra con colgador.



JUEGO DE FORMONES



COMPOSICIÓN

5 formones 10, 12, 16, 20, 25 mm.

- Hoja de acero rectificad.
- Mango bimat



Cód.	Nº Piezas	P.V.P. unid. €	
171238	5	24,20	3

Se suministra en blíster.

LIMAS

Medida mm	Basto	Entrefino
100	14	20
150	11	16
200	10	14
250	9	12
300	8	11
350	7	10

Nº de dientes por cada 10 mm.

	Lima plana
	Lima de media caña
	Lima redonda
	Lima cuadrada
	Lima triangular



09



LIMA PLANA

ACERO CARBONO



Cód.	L mm	L "	Nº dientes	P.V.P. unid. €	
DENTADO ENTREFINO					
197499	100	4	20	5,23	6
197500	150	6	16	5,92	6
197502	200	8	14	8,84	6
197504	250	10	12	11,65	6
197505	300	12	11	15,06	6
197506	350	14	10	15,88	6
DENTADO BASTO					
197702	200	8	10	8,28	6
197704	250	10	9	11,11	6
197705	300	12	8	13,69	6

Se suministra con colgador



LIMA DE MEDIA CANA

ACERO CARBONO



Cód.	L mm	L "	Nº dientes	P.V.P. unid. €	
DENTADO ENTREFINO					
197509	100	4	20	5,65	6
197510	150	6	16	6,39	6
197512	200	8	14	9,57	6
197514	250	10	12	13,08	6
197515	300	12	11	15,61	6
197516	350	14	10	17,00	6
DENTADO BASTO					
197710	200	8	10	8,91	6
197712	250	10	9	12,17	6
197714	300	12	8	14,51	6

Se suministra con colgador



LIMA REDONDA



Cód.	L mm	L "	Nº dientes	P.V.P. unid. €	
DENTADO ENTREFINO					
197518	100	4	20	4,87	6
197519	150	6	16	5,58	6
197520	200	8	14	7,70	6
197521	250	10	12	10,85	6
DENTADO BASTO					
197720	200	8	10	7,00	6
197721	250	10	9	9,82	6

Se suministra con colgador.



LIMA CUADRADA



Entrefinas



Bastas



Cód.	L mm	L "	Nº dientes	P.V.P. unid. €	
DENTADO ENTREFINO					
197524	150	6	16	5,95	6
197525	200	8	14	7,58	6
197526	250	10	12	10,63	6
DENTADO BASTO					
197725	200	8	10	6,79	6

Se suministra con colgador.



LIMA TRIANGULAR



Entrefinas



Bastas



Cód.	L mm	L "	Nº dientes	P.V.P. unid. €	
DENTADO ENTREFINO					
197528	100	4	20	4,44	6
197529	150	6	16	6,09	6
197530	200	8	14	8,18	6
197531	250	10	12	10,85	6
DENTADO BASTO					
197730	200	8	10	7,23	6

Se suministra con colgador.



LIMA PARA MOTOSIERRAS



EMPLEO EN AFILADO DE CADENAS DE MOTOSIERRA.

Cód.	L mm	L "	Ø mm	P.V.P. unid. €	
197601	150	6	3,5	3,05	6
197603	200	8	4,5	3,29	6
197605	200	10	5,5	3,53	6





Se suministra en bolsa.





JUEGO DE LIMAS ENTREFINAS DE 200 MM

COMPOSICIÓN





-  1 lima plana de 200 mm (197502).
-  1 lima de media caña de 200 mm (197512).
-  1 lima redonda de 200 mm (197520).
-  1 lima cuadrada de 200 mm (197525).
-  1 lima triangular de 200 mm (197530).

Cód.	Nº Piezas	P.V.P. unid. €	
197550	5	42,91	1



JUEGO DE LIMAS ENTREFINAS DE 150 MM

COMPOSICIÓN

-  1 lima plana de 150 mm (197500).
-  1 lima de media caña de 150 mm (197510).
-  1 lima redonda de 150 mm (197519).
-  1 lima cuadrada de 150 mm (197524).
-  1 lima triangular de 150 mm (197529).

Cód.	Nº Piezas	P.V.P. unid. €	
197552	5	29,93	1







09



JUEGO DE LIMAS BASTAS EN BOLSA DE NYLON

COMPOSICIÓN

-  1 lima plana de 200 mm (197702).
-  1 lima de media caña de 200 mm (197710).
-  1 lima redonda de 200 mm (197720).
-  1 lima cuadrada de 200 mm (197725).
-  1 lima triangular de 200 mm (197730).

BASTO
L:200 MM







Cód.	Nº Piezas	P.V.P. unid. €	
197554	5	40,98	1



JUEGO DE LIMAS DE AGUJA

- Acero aleado templado HRC62.

COMPOSICIÓN

-  1 lima plana de 100 mm.
-  1 lima de media caña de 100 mm.
-  1 lima redonda de 100 mm.
-  1 lima cuadrada de 100 mm.
-  1 lima triangular de 100 mm.
-  1 lima plana punta de 100 mm.

Ø 3 MM
L: 100 MM

Cód.	Nº Piezas	P.V.P. unid. €	
197495	6	12,44	1





ESCOFINA DE MEDIA CAÑA

ACERO CARBONO



- Acero aleado templado entre 60 ÷ 65 HRC.
- Dentado picado especial para trabajo sobre madera.
- Mango ergonómico bimaterral.



Cód.	L mm	L "	P.V.P. unid. €	
197539	150	6	5,89	6
197540	200	8	9,07	6
197541	250	10	12,01	6

Se suministra con colgador.



ESCOFINA PLANA

ACERO CARBONO



Cód.	L mm	L "	P.V.P. unid. €	
197534	150	6	6,09	6
197535	200	8	8,31	6
197536	250	10	11,34	6

Se suministra con colgador.



ESCOFINA REDONDA

ACERO CARBONO



Cód.	L mm	L "	P.V.P. unid. €	
197544	150	6	4,88	6
197545	200	8	7,28	6
197546	250	10	9,91	6

Se suministra con colgador.



JUEGO DE ESCOFINAS EN BOLSA DE NYLON

COMPOSICIÓN

- 1 lima plana de 200 mm (197535).
- 1 lima de media caña de 200 mm (197540).
- 1 lima redonda de 200 mm (197545).

LONGITUD
200 MM

Cód.	Nº Piezas	P.V.P. unid. €	
197549	3	24,54	1



JUEGO DE MINIESCOFINAS EN CAJA DE PLÁSTICO

COMPOSICIÓN

- 1 miniescofina plana 100 mm.
- 1 miniescofina media caña 100 mm.
- 1 miniescofina redonda 100 mm.
- 1 miniescofina cuadrada 100 mm.
- 1 miniescofina triangular 100 mm.
- 1 miniescofina plana punta 100 mm.

Cód.	Nº Piezas	P.V.P. unid. €	
197497	6	15,49	1

Ø 3 MM
L: 100 MM





BARRENO SALOMÓNICO, MANGO HEXAGONAL

- Con doble filo de corte.
- Hélice de doble entrada para mayor capacidad de corte.
- Guía roscada en la punta.
- Filos de corte rectificados.

LONGITUD
400 MM

Cód.	Ø mm	P.V.P. unid. €	
131110	10	22,42	6
131112	12	23,09	6
131114	14	25,58	6
131116	16	28,60	6
131117	17	29,89	6
131118	18	31,12	6
131120	20	31,13	6



Hélice rectificada de 300 mm



SISTEMA DE AMARRE:
- Hexágono de 1/2"
- Ranura de acoplamiento rápido para hta. neumática y eléctrica



BARRENO SALOMÓNICO, OJO DE BARRIL

Cód.	Ø mm	P.V.P. unid. €	
131002	8	22,06	6
131004	10	23,88	6
131006	12	24,56	6
131008	14	26,34	6
131010	16	31,62	6
131011	17	32,59	6
131012	18	34,14	6
131014	20	41,42	6
131016	22	42,77	6
131018	24	43,56	6
131020	26	46,30	6
131022	28	47,99	6
131024	30	49,47	6

LONGITUD 400 MM
DOBLE FILO DE CORTE



09

EMPLEO PARA ENCOFRADOS
Y TRAVIESAS DE VÍAS FÉRREAS.



BARRENA PARA MÁQUINA

Cód.	Ø mm	L mm	P.V.P. unid. €	
131031	16	285	32,06	10
131032	17	285	34,44	10
131033	18	285	36,48	10

DOBLE FILO
DE CORTE



EMPLEO PARA EL TALADRADO DE
TRAVIESAS DE VÍAS FÉRREAS.



CEPILLO METÁLICO CIRCULAR

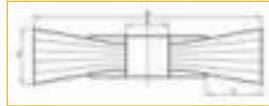

Cada cepillo se suministra con diferentes adaptadores para montar sobre ejes lisos: Ø 12, 16, 20, 22, 25 y 32 mm

Cód.	Ø D mm	C mm	L x E mm	Máx. RPM	P.V.P. unid. €	
197602	150	20	30x32	6500	17,11	1
197604	175	20	45x32	6000	18,54	1
197606	200	20	55x32	4500	21,47	1

Se suministra en estuche individual.



Empleo en limpieza de cascarilla de piezas de forja y fundición. Eliminación de todo tipo de óxidos, pinturas y rebabas.



CEPILLO METÁLICO CIRCULAR ONDULADO

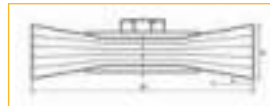

197652
Alambre en Acero inox.



Sujeción casquillo roscado de M14.

Cód.	Ø D mm	C mm	L mm	Máx. RPM	P.V.P. unid. €	
197650	115	20	30	8500	11,05	1
197652	115	20	30	8500	21,33	1

Se suministra en estuche individual.



Empleo en limpieza de cascarilla de piezas de forja y fundición. Eliminación de todo tipo de óxidos, pinturas y rebabas.



CEPILLO DE TAZA ONDULADO



Sujeción casquillo roscado de M14.

Cód.	Ø D mm	L mm	Máx. RPM	P.V.P. unid. €	
197610	75	20	12500	10,47	1
197614	100	25	8500	15,70	1
197612	125	25	6500	18,61	1

Se suministra en estuche individual.



Empleo en trabajos sobre superficies amplias.



CEPILLO DE TAZA TRENZADO



Sujeción casquillo roscado de M14.

Cód.	Ø D mm	L mm	Máx. RPM	P.V.P. unid. €	
197622	100	25	8500	19,43	1
197624	125	25	6500	24,15	1

Se suministra en estuche individual.



Empleo sobre superficies amplias que requieran gran capacidad de arranque de material.



CEPILLO PARA MINIAMOLADORAS



Sujeción casquillo roscado de M14.

Cód.	Ø D mm	L mm	Máx. RPM	P.V.P. unid. €	
197620	75	25	12500	11,63	1

Se suministra en estuche individual.



Empleo sobre superficies amplias que requieran gran capacidad de arranque de material.

09



CEPILLO DE ARRANQUE DE PINTURA

Empleo en arranque de pintura.



Cód.	Ø D mm	C mm	L mm	E mm	P.V.P. unid. €	
197651	100	15	35	12	12,18	5

Se suministra en blíster.



CEPILLO DE ARRANQUE CON VÁSTAGO

Empleo en arranque de pintura.

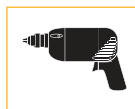

Cód.	Ø D mm	P.V.P. unid. €	
197656	75	7,12	5

Se suministra en blíster.

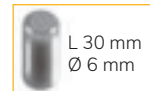

CEPILLO CILÍNDRICO ONDULADO CON VÁSTAGO



Empleo en trabajos de limpieza y eliminación de pinturas, óxidos y pequeñas rebabas.

Cód.	Ø D mm	C mm	Máx. RPM	P.V.P. unid. €	
197630	50	6	4500	2,67	12
197632	75	6	4500	3,51	12
197635	100	6	4500	4,42	12

Se suministra en blíster.

CEPILLO DE TAZA ONDULADO CON VÁSTAGO



Empleo en trabajos de limpieza y eliminación de pinturas, óxidos y pequeñas rebabas.

Cód.	Ø D mm	L mm	Máx. RPM	P.V.P. unid. €	
197640	50	20	4500	2,86	12
197642	75	20	4500	3,78	12

Se suministra en blíster.

09 CEPILLO DE BROCHA ONDULADO



Cód.	Ø D mm	L mm	Máx. RPM	P.V.P. unid. €	
197645	24	25	4500	4,12	12

Se suministra en blíster.

Empleo en trabajos de bricolaje en lugares de difícil acceso.



CEPILLO CILÍNDRICO ONDULADO CON VÁSTAGO



Filamentos flexibles de nylon con grano abrasivo. **Empleo en trabajos ligeros de bricolaje.**

Cód.	Ø D mm	Máx. RPM	P.V.P. unid. €	
197655	75	4500	8,12	12
197658	100	4500	9,56	12

Se suministra en blíster.

CEPILLO CILÍNDRICO ONDULADO CON VÁSTAGO



Filamentos flexibles de nylon con grano abrasivo. **Empleo en trabajos ligeros de bricolaje.**

Cód.	Ø D mm	L mm	Máx. RPM	P.V.P. unid. €	
197660	50	20	4500	8,14	12
197662	75	20	4500	9,37	12

Se suministra en blíster.



CEPILLO MANUAL DE ACERO LATONADO REFORZADO



25% MAYOR DENSIDAD DE ALAMBRES.



Cód.	L mm	A mm	S mm	P.V.P. unid. €	
197556	225	28	125	3,09	24

Empleo en trabajos ligeros y en lugares de difícil acceso.



CEPILLO MANUAL DE ACERO LATONADO



Cód.	L mm	A mm	S mm	P.V.P. unid. €	
197555	225	28	125	2,33	24



CEPILLO MANUAL DE ACERO INOXIDABLE



Especialmente indicado para cepillar Acero inoxidable

Cód.	L mm	A mm	S mm	P.V.P. unid. €	
197558	225	28	125	5,00	24

09



MINICEPILLO DE ACERO LATONADO



Cód.	L mm	P.V.P. unid. €	
197561	150	2,96	20



MINICEPILLO DE ACERO INOXIDABLE

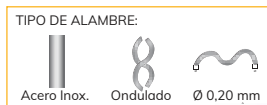

Cód.	L mm	P.V.P. unid. €		Indicado para cepillar Acero inoxidable.
197562	150	3,08	20	



CEPILLO MANUAL CON MANGO DE MADERA



Trabajos ligeros de limpieza de pinturas, óxidos y rebabas, etc.



Cód.	L mm	A mm	S mm	P.V.P. unid. €	
197560	300	28	135	2,69	12



CEPILLO MANUAL DE FUNDICIÓN



Trabajos fuertes de cepillado.



Cód.	L mm	A mm	P.V.P. unid. €	
197565	200	34	4,42	12



CORONA PERFORADORA

- Dentado en acero rápido (HSS).
Temple entre 63-65 HRC.
- Cuerpo fabricado en acero aleado de gran flexibilidad.
- Soldado por haz de electrones.

BIMETÁLICA

INSTRUCCIONES DE USO

Dentro de cada caja de cartón se incluye una hoja técnica con las RPM que han de utilizarse en función del material a cortar y el diámetro de corona a emplear.

Coronas para aplicaciones en metales, maderas y plásticos en general.

Máxima profundidad de corte de 38mm.

Base de la corona reforzada para reducir las vibraciones que se producen durante el corte.



Cód.	Ø mm	P.V.P. unid. €	
197014	14	9,58	1
197016	16	9,58	1
197017	17	9,58	1
197019	19	9,58	1
197020	20	9,58	1
197021	21	9,92	1
197022	22	9,92	1
197024	24	10,37	1
197025	25	10,37	1
197027	27	11,16	1
197029	29	11,16	1
197030	30	12,02	1
197032	32	12,02	1
197033	33	12,05	1
197035	35	12,85	1
197037	37	13,04	1
197038	38	13,21	1
197040	40	13,67	1

Cód.	Ø mm	P.V.P. unid. €	
197041	41	13,94	1
197043	43	13,99	1
197044	44	14,50	1
197046	46	14,86	1
197048	48	14,86	1
197051	51	15,31	1
197052	52	15,46	1
197054	54	15,69	1
197056	56	15,96	1
197057	57	16,13	1
197059	59	16,57	1
197060	60	17,00	1
197064	64	17,78	1
197065	65	18,19	1
197067	67	18,63	1
197068	68	19,00	1
197070	70	19,44	1
197073	73	20,34	1

Cód.	Ø mm	P.V.P. unid. €	
197076	76	21,08	1
197079	79	21,94	1
197083	83	23,00	1
197086	86	23,41	1
197089	89	24,26	1
197092	92	26,48	1
197095	95	28,52	1
197098	98	29,70	1
197102	102	31,36	1
197105	105	33,11	1
197108	108	40,60	1
197111	111	42,75	1
197114	114	48,10	1
197121	121	56,31	1
197127	127	58,87	1
197140	140	69,75	1
197152	152	74,42	1

09



HUSILLO PARA CORONAS

- Husillo fabricado en acero aleado de gran elasticidad.
- Broca guía en acero rápido HSS.

PARA CORONAS DE Ø 14-30 MM



Cód.	Hexágono	P.V.P. unid. €	
197210	3/8"	11,63	1



HUSILLO PARA CORONAS

- Husillo fabricado en acero aleado de gran elasticidad.
- Broca guía en acero rápido HSS.

PARA CORONAS DE Ø 32-152 MM



Cód.	Hexágono	P.V.P. unid. €	
197200	7/16"	18,61	1



HUSILLO SDS-PLUS

Cód.	P.V.P. unid. €	
197212	22,09	1



PARA CORONAS DE Ø 32-152 MM



Mango SDS-Plus



JUEGO DE CORONAS ELECTRICISTA

COMPOSICIÓN

- 6 Coronas: 22, 29, 35, 44, 51, 64 mm.
- 2 Husillos para coronas: 7/16" (32-152 mm), 3/8" (14-30 mm).
- 1 Llave allen para husillos.



Cód.	Nº Piezas	P.V.P. unid. €	
197160	9	98,84	1



JUEGO DE CORONAS ELECTRICISTA/FONTANERO

COMPOSICIÓN

- 9 Coronas: 19, 22, 29, 35, 38, 44, 51, 57, 64 mm.
- 2 Husillos para coronas: 7/16" (32-152 mm), 3/8" (14-30 mm).
- 1 Llave allen para husillos.



Cód.	Nº Piezas	P.V.P. unid. €	
197170	12	122,10	1

09



BROCA GUÍA PARA HUSILLOS

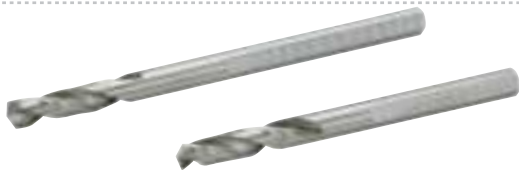

Cód.	L mm	P.V.P. unid. €	
197215	1/4"x81	4,38	10
197220	1/4"x102	4,56	10



ALARGADERA PARA HUSILLOS



Cód.	L mm	P.V.P. unid. €	
197250	300	17,53	1



ADAPTADOR

- Para utilizar con coronas desde 32 mm, con husillo de 3/8".



Cód.	P.V.P. unid. €	
197230	6,17	1



MUELLE



Cód.	P.V.P. unid. €	
197240	1,10	1



BROCA PARA METAL HSS

DIN 338

ACERO HSS



Hélice endurecida a 63-66 HRC

Punta 135°



Afilado autocentrante (SP)

Cód.	Ø mm	P.V.P. unid. €	
120100	1,00	0,48	10
120125	1,25	0,49	10
120150	1,50	0,50	10
120175	1,75	0,50	10
120200	2,00	0,50	10
120225	2,25	0,50	10
120250	2,50	0,50	10
120275	2,75	0,50	10
120300	3,00	0,60	10
120325	3,25	0,60	10
120350	3,50	0,83	10
120375	3,75	0,84	10
120400	4,00	0,87	10
120425	4,25	0,87	10
120450	4,50	0,87	10
120475	4,75	0,93	10
120500	5,00	1,05	10

Cód.	Ø mm	P.V.P. unid. €	
120525	5,25	1,05	10
120550	5,50	1,05	10
120575	5,75	1,05	10
120600	6,00	1,43	10
120625	6,25	1,43	10
120650	6,50	1,55	10
120675	6,75	1,69	10
120700	7,00	1,84	10
120725	7,25	1,84	10
120750	7,50	2,02	10
120775	7,75	2,02	10
120800	8,00	2,58	5
120825	8,25	2,58	5
120850	8,50	2,58	5
120875	8,75	2,58	5
120900	9,00	3,08	5
120925	9,25	3,08	5

Cód.	Ø mm	P.V.P. unid. €	
120950	9,50	3,57	5
120975	9,75	3,57	5
121000	10,00	4,05	5
121025	10,25	4,05	5
121050	10,50	4,41	5
121075	10,75	4,66	5
121100	11,00	5,00	5
121125	11,25	5,00	5
121150	11,50	5,00	5
121175	11,75	5,00	5
121200	12,00	6,40	5
121225	12,25	6,41	5
121250	12,50	6,41	5
121275	12,75	6,41	5
121300	13,00	7,45	5

09



JUEGO DE BROCAS HSS

DIN 338

ACERO HSS

COMPOSICIÓN

1 - 10 x 0,5 mm.
 1, 1'5, 2, 2'5, 3, 3'5, 4, 4'5,
 5, 5'5, 6, 6'5, 7, 7'5, 8, 8'5,
 9, 9'5, 10 mm.

Cód.	Nº Piezas	P.V.P. unid. €	
121320	19	40,54	1





JUEGO DE BROCAS HSS

DIN
338ACERO
HSS

COMPOSICIÓN

1 - 13 x 0,5 mm.
1, 1'5, 2, 2'5, 3, 3'5, 4, 4'5,
5, 5'5, 6, 6'5, 7, 7'5, 8, 8'5,
9, 9'5, 10, 10'5, 11, 11'5,
12, 12'5, 13 mm.

Cód.	Nº Piezas	P.V.P. unid. €	
121330	25	83,21	1



JUEGO DE MACHOS Y COJINETES EN CAJA METÁLICA

COMPOSICIÓN

21 Machos HSS: M3, M4, M5, M6, M8, M10, M12 (x3).
7 Cojinetes HSS: M3, M4, M5, M6, M8, M10, M12.
1 Portamachos forjado.
1 Portacojinetes forjado.
1 Avellanador.

Cód.	Nº Piezas	P.V.P. unid. €	
121350	31	219,28	1



09



PORTAMACHOS



Cód.	Para métrica	L mm	P.V.P. unid. €	
122347	M3-M12	210	11,79	1

Se suministra en blíster.



PORTACOJINETES



Cód.	Ø mm	L mm	P.V.P. unid. €	
122342	25,4	210	8,41	1

Se suministra en blíster.



VOLVEDOR PARA MACHOS DE ROSCAR

ACERO
CR-V

■ Terminación satinado mate.



122340



122345

Cód.	Para métrica	L mm	P.V.P. unid. €	
122340	M3-M8	85	24,83	1
122345	M5-M12	100	29,48	1

Se suministra con colgador.





BROCA DE MANGO CILÍNDRICO PARA HORMIGÓN

DIN 8039

ACERO CARBONO



Broca no apta para taladrar metales.

- Fabricada en Acero al Carbono templado.
- Hélice fresada.
- Punta fabricada en Carburo de Tungsteno, lo que le confiere una gran capacidad de corte y una vida útil más larga.
- Gran resistencia al desgaste y al estrés por torsión.



UTILIZACIÓN

- Hormigón.
- Ladrillo.
- Piedra.
- Baldosa.
- Mármol.
- Granito.
- Pizarra.



BROCA SDS-PLUS PARA HORMIGÓN

DIN 8039

ACERO CARBONO



Broca no apta para taladrar metales.

- Fabricada en Acero aleado y templado entre 42÷50 HRC.
- Hélice de 4 canales. Evacuación más eficaz del polvo. Mayor velocidad de taladrado y vida útil más larga. Gran resistencia al desgaste y estrés por torsión.
- Punta de Carburo de Tungsteno (gran capacidad de corte).
- Acabado Granallado fino y aceite anti-oxidación.
- Broca preparada para trabajos de percusión.

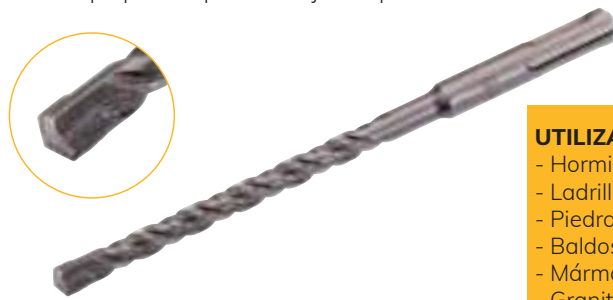

UTILIZACIÓN

- Hormigón.
- Ladrillo.
- Piedra.
- Baldosa.
- Mármol.
- Granito.
- Pizarra.

09

Cód.	Ø mm	L mm	P.V.P. unid. €	
122003	3	70	1,75	10
122004	4	75	1,96	10
122005	5	85	2,08	10
122006	6	100	2,86	10
122036	6	200	3,81	5
122046	6	400	7,27	1
122007	7	100	2,86	10
122008	8	120	3,92	10
122038	8	200	4,27	5
122048	8	400	7,65	1
122009	9	120	3,92	5
122010	10	120	5,37	10
122040	10	200	6,12	5
122050	10	400	10,43	1
122011	11	150	5,53	5
122012	12	150	5,70	5
122052	12	400	13,53	1
122013	13	150	7,73	5
122014	14	150	7,95	5
122054	14	400	16,24	1
122015	15	150	9,85	1
122016	16	150	10,30	1
122056	16	400	20,04	1
122018	18	160	12,69	1
122058	18	400	22,43	1
122020	20	160	14,84	1
122060	20	400	26,97	1
122022	22	160	18,00	1
122062	22	400	30,73	1



Cód.	Ø mm	L mm	P.V.P. unid. €	
122104	4	110	4,62	5
122105	5	110	4,62	5
122106	6	110	4,62	5
122126	6	210	8,03	1
122146	6	260	12,18	1
122107	7	110	6,04	5
122108	8	110	6,04	5
122128	8	210	8,43	1
122148	8	260	10,61	1
122109	9	110	6,30	5
122110	10	110	6,62	5
122130	10	210	9,37	1
122150	10	260	11,84	1
122111	11	160	8,30	1
122112	12	160	9,47	1
122132	12	210	10,46	1
122152	12	260	12,68	1
122113	13	160	13,42	1
122114	14	160	13,69	1
122134	14	210	15,43	1
122154	14	260	16,77	1
122115	15	160	15,45	1
122116	16	160	15,57	1
122136	16	210	18,51	1
122156	16	260	21,45	1
122117	17	210	25,41	1
122118	18	210	26,04	1
122119	19	210	27,66	1
122120	20	210	28,57	1



Se suministra con colgador.

Se suministra con colgador.

 **JUEGO DE BROÇAS PARA HORMIGÓN**

COMPOSICIÓN

5x110, 6x110, 8x110, 10x110 mm.



Cód.	Nº Piezas	P.V.P. unid. €	
122170	4	23,26	1

 **JUEGO DE BROÇAS PARA HORMIGÓN**

COMPOSICIÓN

5x110, 6x110, 8x110, 8x160, 10x160, 12x160 mm.



Cód.	Nº Piezas	P.V.P. unid. €	
122180	6	39,21	1

 **JUEGO DE BROÇAS PARA HORMIGÓN**

COMPOSICIÓN

4x75, 5x85, 6x100, 8x120, 10x120 mm.



Cód.	Nº Piezas	P.V.P. unid. €	
122070	5	15,95	1

 **JUEGO DE BROÇAS PARA HORMIGÓN**

COMPOSICIÓN



3x70, 4x75, 5x85, 6x100, 7x100, 8x120, 9x120, 10x120 mm.



Cód.	Nº Piezas	P.V.P. unid. €	
122080	8	22,98	1

09

 **BROCA HELICOIDAL PARA MADERA Y PLÁSTICO**

Cód.	Ø mm	P.V.P. unid. €		Cód.	Ø mm	P.V.P. unid. €	
136001	3	2,61	12	136006	8	3,19	12
136002	4	2,65	12	136008	10	4,20	12
136003	5	2,78	12	136010	12	6,06	12
136004	6	2,84	12	136012	14	8,82	12
136005	7	3,14	12	136014	16	13,53	12





 **JUEGO DE BROÇAS PARA MADERA Y PLÁSTICO**

COMPOSICIÓN

4, 5, 6, 8, 10 mm.



Cód.	Nº Piezas	P.V.P. unid. €	
136205	5	13,94	1

 **JUEGO DE BROÇAS PARA MADERA Y PLÁSTICO**

COMPOSICIÓN

3, 4, 5, 6, 7, 8, 9, 10 mm.



Cód.	Nº Piezas	P.V.P. unid. €	
136208	8	16,28	1



BROCA PLANA



Sistema de amarre con ranura de acoplamiento rápido en el mango



Cód.	Ø mm	P.V.P. unid. €		Cód.	Ø mm	P.V.P. unid. €		Cód.	Ø mm	P.V.P. unid. €	
135011	6	3,87	12	135015	18	5,82	12	135007	28	7,05	12
135012	8	5,07	12	135004	19	5,84	12	135008	30	7,20	12
135001	10	5,20	12	135016	20	5,91	12	135009	32	7,30	12
135002	12	5,29	12	135005	22	5,95	12	135019	34	7,52	12
135013	14	5,48	12	135017	24	5,99	12	135010	35	7,66	12
135003	16	5,73	12	135006	25	6,02	12	135020	36	7,68	12
135014	17	5,74	12	135018	26	6,05	12	135021	38	7,87	12
								135022	40	7,93	12

Se suministra con colgador.



JUEGO DE BROCAS PLANAS

09

COMPOSICIÓN

135070: 10, 12, 16, 19, 22, 25 mm.

135080: 10, 13, 16, 18, 20, 22, 25, 28, 32, 35 y 40 mm.

Cód.	Nº piezas	P.V.P. unid. €	
135070	6	28,24	1
135080	11	60,75	1



135070



135080



ALARGADERA PARA BROCAS PLANAS

■ Longitud total de broca + alargadera: 450 mm.

Cód.	L mm	P.V.P. unid. €	
135051	300	14,18	1



FRESA PARA BISAGRAS

■ Fresas con plaquitas de widia soldadas.

Cód.	Ø mm	L mm	P.V.P. unid. €	
138010	15	90	9,88	1
138011	20	90	16,78	1
138001	26	90	17,70	1
138002	30	90	18,63	1
138003	35	90	22,18	1
138012	40	90	25,01	1
138013	45	90	27,69	1
138014	50	90	31,44	1



10

JARDINERÍA

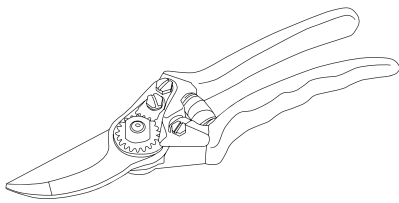

Tijera de poda **270**

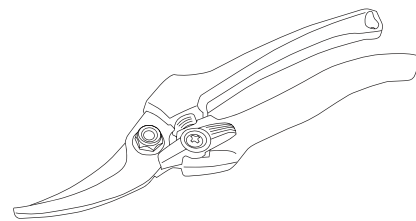

Tijera de vendimia **271**

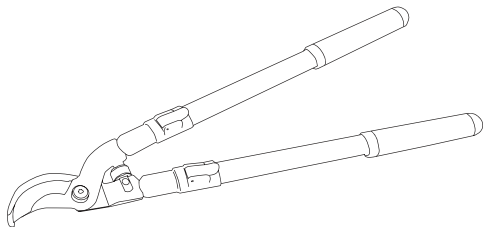

Tijera de dos manos **272**

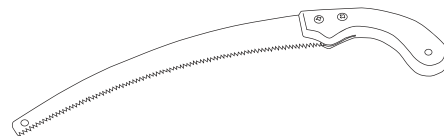

Serrucho de poda **273**



TIJERA DE PODA MANGO GIRATORIO

ACERO SK5 Poda Recolección 25 mm

Capacidad de corte



MANGO GIRATORIO

Reduce la fatiga y el esfuerzo.
30%

Cód.	L mm	L "	P.V.P unid. €	
108420	220	9	32,24	10

Se suministra en blíster.
Repuestos de hoja, contrahoja y muelle disponibles.



TIJERA DE PODA MANGOS ALUMINIO

ACERO SK5 Poda Recolección 25 mm

Capacidad de corte

10

- Cuerpo en Aluminio forjado.
- Muelle de apertura automática.
- Mangos ergonómicos antideslizantes.
- Cierre de seguridad.

Cód.	L mm	L "	P.V.P unid. €	
108415	220	9	21,18	10

Se suministra en blíster.
Repuestos de hoja, contrahoja y muelle disponibles.



TIJERA DE PODA MANGOS DE ACERO

ACERO SK5 Poda Recolección 22 mm

Capacidad de corte

- Mangos fabricados en Acero.
- Muelle de apertura automática.
- Mangos ergonómicos antideslizantes.
- Cierre de seguridad.

Cód.	L mm	L "	P.V.P unid. €	
108425	220	9	17,24	10

Se suministra en blíster.





TIJERA DE PODA FORJADA

ACERO FORJADO



Capacidad de corte 108400

Capacidad de corte 108405

TIJERA FORJADA



- Filos de corte templados.
- Corte fácil y limpio by-pass.
- Muelle de apertura automática.
- Con cierre de seguridad.

Cód.	L mm	L "	P.V.P unid. €	
108400	180	7	8,86	6
108405	220	9	10,85	6

Se suministra en blíster.



TIJERA DE VENDIMIA Y RECOLECCIÓN

ACERO SK5



Capacidad de corte

- Cuchillas de corte pavonadas.
- Muelle de apertura automática.
- Mangos ergonómicos en plástico ABS.
- Cierre de seguridad.

Cód.	L mm	L "	P.V.P unid. €	
108410	180	7	7,54	10

Se suministra en blíster.



10



AFILADOR

- Filo de carburo de tungsteno.
- Cuerpo de plástico.
- Para afilar todo tipo de tijeras y cuchillos.

Cód.	L mm	P.V.P unid. €	
108492	200	12,06	10

Se suministra en blíster.



Afilado



Aceitado



AFILADOR BASTO

- Filo de carburo de tungsteno.
- Cuerpo de plástico.
- Para afilar todo tipo de tijeras y cuchillos.

ESPECIAL DESBASTES

Cód.	L mm	P.V.P unid. €	
108490	120	11,57	10

Se suministra en blíster.



Afilado



Aceitado





TIJERA DE 2 MANOS DE PODA



Capacidad de corte



Cód.	L mm	L "	P.V.P unid. €	
108520	680	27	30,18	1

Repuestos de hoja, contrahoja, mangos y topes de goma disponibles.



TIJERA DE 2 MANOS EXTENSIBLE



Capacidad de corte

■ Mismas características que 108520.

EXTENSIBLE

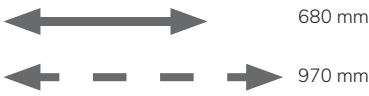

Cód.	L mm	L "	P.V.P unid. €	
108525	680-970	27-39	36,02	1

Repuestos de hoja, contrahoja, mangos y topes de goma disponibles.



TIJERA DE 2 MANOS ARTICULADA



Capacidad de corte

- Mangos ergonómicos antideslizantes.
- Cuchilla teflonada. Sufridera de aluminio.



Cód.	L mm	L "	P.V.P unid. €	
108530	820	33	36,05	1





TIJERA CORTASETOS

HOJA DE 210 MM
FILOS TEFLONADOS



Cód.	L mm	L "	P.V.P unid. €	
108505	580	23	27,77	1



TIJERA CORTASETOS EXTENSIBLE

■ Mismas características que 108505.

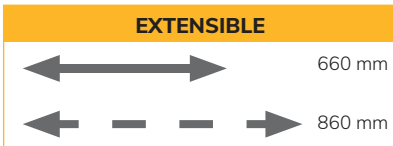

Cód.	L mm	L "	P.V.P unid. €	
108510	660-860	26-34	35,92	1



SERRUCHO DE PODA

■ Funda de plástico para cinturón incluida.

Cód.	L mm	L "	P.V.P unid. €	
144092	480	19	14,77	12



SERRUCHO ABATIBLE DE PODA

■ Serrucho abatible con cierre de seguridad.
■ Mango bimaterial ergonómico.

Cód.	L abierto mm	L cerrado mm	P.V.P unid. €	
144097	400	240	11,07	6





PALETÍN DE JARDINERÍA

Cód.	Medida mm	P.V.P unid. €	
108550	350x80	5,41	12



RASTRILLO DE JARDINERÍA



Cód.	Medida mm	P.V.P unid. €	
108555	325x80	6,15	12



AZADA-RASTRILLO DE JARDINERÍA



Cód.	Medida mm	P.V.P unid. €	
108560	325x80x75	5,41	12



ESCOBA METÁLICA

■ Escoba en Acero.



Cód.	Nº púas	Medida mm	P.V.P unid. €	
198518	22	425x400	5,38	6

Se suministra sin mango.



ESCOBA DE PVC

■ Escoba en PVC.



Cód.	Nº púas	Medida mm	P.V.P unid. €	
198520	22	480x430	7,38	6

Se suministra sin mango.

10



MANGOS PARA ESCOBAS

Cód.	Para Cód.	Tipo	L mm	Ø mm	P.V.P unid. €	
198519	198518	Recto	1200	24	4,94	6
198521	198520	Recto	1200	24	4,92	6



BOLSA DE NYLON PARA TIJERAS

Polyester 600D

0,2 KG

Cód.	Medida mm	P.V.P unid. €	
196848	220x90	5,33	1



10x220x90 mm.



Posibilidad de sujeción al cinturón.



11

CONSTRUCCIÓN

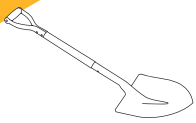

Pala de Acero

276

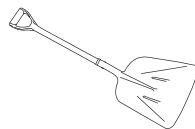

Pala de Aluminio

277

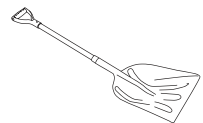

Pala de Plástico

277



Raedera

278

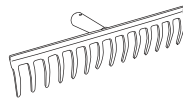

Rastrillo

279

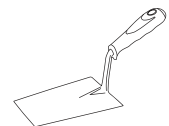

Paleta

280

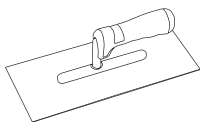

Llana

283

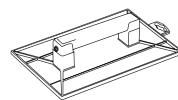

Talocha

284



Barra de desencofrar

285

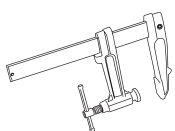

Tornillo de apriete

286

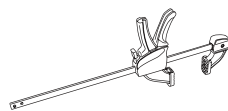

Sargento de plástico

289

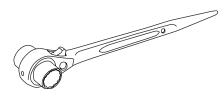

Carraca de andamio

290

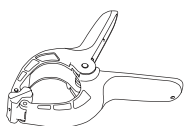

Pinza

290



Plomada

290

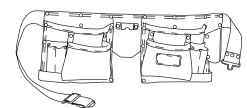

Bolsa porta herramientas

291



PALA PUNTA, MANGO MULETA

PEDIDO MÍNIMO 6 PALAS O MULTIPLOS



Mango en T

Cód.	Medida mm	L mm	P.V.P. unid. €	
198600	280x340	1000	17,97	6
198604	280x340	1200	18,58	6

Ver mangos en pág. 278.



PALA PUNTA, MANGO ANILLA

PEDIDO MÍNIMO 6 PALAS O MULTIPLOS



Mango en Anilla

Cód.	Medida mm	L mm	P.V.P. unid. €	
198610	280x340	1000	19,10	6

Ver mangos en pág. 278.



PALA CUADRADA, MANGO MULETA

PEDIDO MÍNIMO 6 PALAS O MULTIPLOS



Mango en T

Cód.	Medida mm	L mm	P.V.P. unid. €	
198605	280x340	1000	18,16	6

Ver mangos en pág. 278.



PALA CUADRADA, MANGO ANILLA

PEDIDO MÍNIMO 6 PALAS O MULTIPLOS



Mango en Anilla

Cód.	Medida mm	L mm	P.V.P. unid. €	
198615	280x340	1000	19,39	6

Ver mangos en pág. 278.



PALA PUNTA, MANGO FIBRA DE VIDRIO

PEDIDO MÍNIMO 6 PALAS O MULTIPLOS



Mango en Anilla

Cód.	Medida mm	L mm	P.V.P. unid. €	
198613	280x340	1000	26,94	6

Ver mangos en pág. 278.



PALOTE, MANGO MADERA

PEDIDO MÍNIMO 6 PALOTES O MULTIPLOS



Mango Recto

Cód.	Medida AxBxC mm	L mm	P.V.P. unid. €	
198603	158x192x255	1220	17,16	6

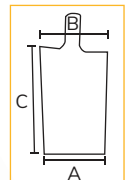



MINIPALA PUNTA, MANGO DE MADERA



Mango en Anilla

Cód.	Medida mm	L mm	P.V.P. unid. €	
198614	150x210	750	10,96	6



25 %
MÁS CORTA



PALA DE ALUMINIO, MANGO DE MADERA

- Pala fabricada en Aluminio.
- Mango con anilla fabricada en plástico duro.

EMPLEO
EN NIEVE



Mango en Anilla

Cód.	Medida mm	L mm	P.V.P. unid. €	
198617	245x300	1000	24,43	6



PALA DE ALUMINIO, MANGO DE MADERA

- Pala fabricada en Aluminio.
- Mango con anilla fabricada en plástico duro.

EMPLEO
EN NIEVE



Mango en Anilla

Cód.	Medida mm	L mm	P.V.P. unid. €	
198619	360x415	1200	32,98	6



PALA DE ALUMINIO, MANGO DE FIBRA

- Pala fabricada en Aluminio.
- Mango fabricado en fibra de vidrio.

Cód.	Medida mm	L mm	P.V.P. unid. €	
198621	360x415	1020	43,98	6

Ver mangos en pág. 278.



Mango en Anilla



ANTI
CORROSIÓN



PALA DE PLÁSTICO, MANGO DE FIBRA

- Pala fabricada en plástico.
- Mango fabricado en fibra de vidrio.

Cód.	Medida mm	L mm	P.V.P. unid. €	
198622	460x360	1250	31,15	6



Mango en Anilla



ANTI
CORROSIÓN





MANGO PARA PALA

Imagen	Cód.	Para código	Tipo	L mm	P.V.P. unid. €	
	198601	198600/198605	Muleta	700	9,75	6
	198611	198610/198615	Anilla	700	10,96	6
	198602	198600/198605	Muleta	815	18,56	6
	198612	198610/198615 198617/198613 198621	Anilla	735	17,54	6



RAEDERA SEMICIRCULAR



■ Con soldadura pala mango.



Mangos acoplables: 198501/198503
Ver a pie de página.

Cód.	Medida mm	P.V.P. unid. €	
198500	260x160	14,88	12



RAEDERA RECTANGULAR



■ Con soldadura pala mango.



Mangos acoplables: 198501/198503
Ver a pie de página.

Cód.	Medida mm	P.V.P. unid. €	
198502	310x138	15,05	12



RASTRILLO 5 PÚAS FORJADO



Mangos acoplables: 198506 / 198507
Ver a pie de página.

Cód.	Medida mm	P.V.P. unid. €	
198505	200x160	26,17	6



LEGÓN



Mango acoplable: 198529
Ver página siguiente.

Cód.	Medida mm	P.V.P. unid. €	
198530	300x150	9,80	6



MANGOS PARA RAEDERAS, RASTRILLOS Y AZADAS



198501

198506

198508

198503

198507

198501 / 198503 para raederas 198500 y 198502 y legón 198530.
198506 / 198507 para rastrillo 198505 y azadas.
198508 para azadas.

Imagen	Cód.	Tipo	Ø mm	L mm	P.V.P. unid. €	
	198501	MADERA	37	1200	8,14	6
	198506	MADERA	40	1000	8,37	6
	198508	MADERA	38	1000	9,70	6
	198503	FIBRA VIDRIO	37	1200	20,10	6
	198507	FIBRA VIDRIO	40	1000	19,27	6

 RASTRILLO

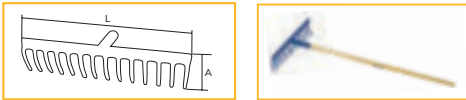

Mango acoplable: 198510, ver a pie de página.

Cód.	Nº púas	A x L mm	P.V.P. unid. €	
198512	12	100x410	9,05	6
198514	14	100x470	10,68	6
198516	16	100x530	11,66	6



 HORCA

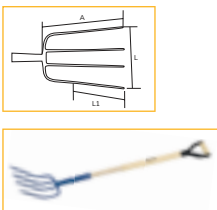

Mangos acoplables: 198527 / 198529, ver a pie de página.

Cód.	Nº púas	A x L x L1 mm	P.V.P. unid. €	
198524	4	327x215x190	13,36	6
198525	5	337x217x195	18,50	6
198526	6	350x245x225	21,67	6



 GARABATO

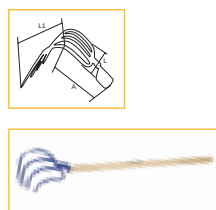

Mango acoplable: 198539, ver a pie de página.

Cód.	Nº púas	A x L x L1 mm	P.V.P. unid. €	
198534	4	200x205x210	11,77	6
198535	5	200x220x220	15,83	6



 HORCA RECTA DE CAVAR

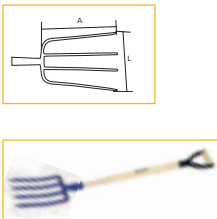

Mango acoplable: 198558, ver a pie de página.

Cód.	Nº púas	A x L mm	P.V.P. unid. €	
198544	4	280x175	16,31	6



 HORCA PARA PIEDRA Y GRAVA



Mango acoplable: 198558, ver a pie de página.

Cód.	Nº púas	A x L mm	P.V.P. unid. €	
198550	9	360x240	22,74	6



 MANGOS PARA RASTRILLOS Y HORCAS

	Imagen	Cód.	Para código	Tipo	L mm	Ø mm	P.V.P. unid. €	
		198510	198512 / 198514 198516	Recto	1200	28	5,94	6
		198527	198524 / 198525 198526	Anilla	960	37	11,25	6
		198529	198524 / 198525 198526 / 198530	Recto	1200	37	8,04	6
		198539	198534 / 198535	Recto	1200	37	8,04	6
		198558	198544 / 198550	Anilla	960	37	10,96	6

PALETA FORJADA

- Hoja barnizada para evitar la oxidación.
- Hoja rectificada cónicamente por ambos lados para una flexión adecuada.
- Hoja y espiga tratadas térmicamente.

▶ HOJA Y MANGO FORJADOS DE UNA SOLA PIEZA

PALETA FORJADA TIPO NORTE, MANGO DE MADERA

Cód.	Medida mm	P.V.P. unid. €	
195900	180x115	14,73	6
195905	190x118	15,27	6



PALETA FORJADA TIPO NORTE, MANGO BIMATERIAL

Cód.	Medida mm	P.V.P. unid. €	
195901	180x115	16,59	6
195906	190x118	17,34	6



PALETA FORJADA TIPO MADRID, MANGO DE MADERA

Cód.	Medida mm	P.V.P. unid. €	
195910	190x104	12,67	6
195915	215x116	13,29	6



PALETA FORJADA TIPO MADRID, MANGO BIMATERIAL

Cód.	Medida mm	P.V.P. unid. €	
195911	190x104	14,50	6
195916	215x116	15,26	6



11 PALETA FORJADA TIPO CATALANA, MANGO DE MADERA

Cód.	Medida mm	P.V.P. unid. €	
195920	150x115	14,34	6
195925	160x120	15,02	6



PALETA FORJADA TIPO CATALANA, MANGO BIMATERIAL

Cód.	Medida mm	P.V.P. unid. €	
195921	150x115	15,85	6
195926	160x120	16,47	6



PALETA FORJADA TIPO SEVILLA, MANGO DE MADERA

Cód.	Medida mm	P.V.P. unid. €	
195930	190x115	15,35	6



PALETA FORJADA TIPO SEVILLA, MANGO BIMATERIAL

Cód.	Medida mm	P.V.P. unid. €	
195931	190x115	16,71	6



PALETA SOLDADA

- Hoja barnizada para evitar la oxidación.
- Hoja rectificada cónicamente por ambos lados para una flexión adecuada.
- Hoja y espiga tratadas térmicamente.

HOJA Y MANGO UNIDOS POR SOLDADURA LÁSER

PALETA SOLDADA TIPO NORTE, MANGO DE MADERA

Cód.	Medida mm	P.V.P. unid. €	
195700	180x115x87	7,22	12
195705	190x118x90	7,95	12



PALETA SOLDADA TIPO NORTE, MANGO BIMATERIAL

Cód.	Medida mm	P.V.P. unid. €	
195701	180x115x87	8,70	12
195706	190x118x90	9,14	12



PALETA SOLDADA TIPO MADRID, MANGO DE MADERA

Cód.	Medida mm	P.V.P. unid. €	
195708	140x80	5,13	12
195710	178x98	6,26	12
195715	200x110	6,55	12
195717	220x120	7,11	12



PALETA SOLDADA TIPO MADRID, MANGO BIMATERIAL

Cód.	Medida mm	P.V.P. unid. €	
195709	140x80	6,69	12
195711	178x98	7,92	12
195716	200x110	8,23	12
195718	220x120	8,65	12



11

PALETA SOLDADA TIPO CATALANA, MANGO DE MADERA

Cód.	Medida mm	P.V.P. unid. €	
195720	155x115	7,20	12
195725	170x120	7,35	12
195723	180x125	7,74	12



PALETA SOLDADA TIPO CATALANA, MANGO BIMATERIAL

Cód.	Medida mm	P.V.P. unid. €	
195721	155x115	8,20	12
195726	170x120	8,34	12
195724	180x125	8,65	12





PALETA SOLDADA TIPO SEVILLA,
MANGO DE MADERA

Cód.	Medida mm	P.V.P. unid. €	
195730	190x115x90	7,54	12



PALETA SOLDADA TIPO SEVILLA,
MANGO BIMATERIAL

Cód.	Medida mm	P.V.P. unid. €	
195731	190x115x90	8,72	12



PALETÍN SOLDADO DE PUNTA
AGUDA, MANGO DE MADERA

Cód.	Medida mm	P.V.P. unid. €	
195740	130x75	5,26	12



PALETÍN SOLDADO DE PUNTA
AGUDA, MANGO BIMATERIAL

Cód.	Medida mm	P.V.P. unid. €	
195741	130x75	6,89	12



11



PALETÍN SOLDADO DE PUNTA
REDONDA, MANGO DE MADERA

Cód.	Medida mm	P.V.P. unid. €	
195750	125x70	5,13	12



PALETÍN SOLDADO DE PUNTA
REDONDA, MANGO BIMATERIAL

Cód.	Medida mm	P.V.P. unid. €	
195751	125x70	6,80	12



PALETÍN SOLDADO HOJA DE
OLIVO, MANGO DE MADERA

Cód.	Medida mm	P.V.P. unid. €	
195760	130x70	5,00	12



PALETÍN SOLDADO HOJA DE
OLIVO, MANGO BIMATERIAL

Cód.	Medida mm	P.V.P. unid. €	
195761	130x70	6,53	12



LLANA RECTANGULAR, MANGO BIMATERIAL

ACERO INOX



Base lisa sin tornillos.

Cód.	Medida mm	P.V.P. unid. €	
195772	280x125	13,18	10

LLANA RECTANGULAR, MANGO MADERA

ACERO INOX



Base lisa sin tornillos.

Cód.	Medida mm	P.V.P. unid. €	
195770	300x150	13,35	6

LLANA RECTANGULAR AFILADA

ACERO INOX



Cantos afilados.



Base lisa sin tornillos.



Cód.	Medida mm	P.V.P. unid. €	
195768	300x150	14,57	6

LLANA RECTANGULAR TRAPEZOIDAL

ACERO INOX



Base lisa sin tornillos.

Cód.	Medida mm	P.V.P. unid. €	
195780	300x140-150	13,11	6

LLANA ALMENADA

ACERO INOX



Cód.	Paso	Medida mm	P.V.P. unid. €	
195785	6x6	280x120	13,49	6
195786	8x8	280x120	14,19	6
195787	10x10	280x120	14,48	6

LLANA MEDIA LUNA

ACERO INOX



Cód.	Medida mm	P.V.P. unid. €	
195774	300x150	13,11	6



LLANA PARA YESERO

ACERO INOX



Cód.	Medida mm	P.V.P. unid. €	
195775	500x130	17,09	6



LLANA ALMENADA PARA YESERO

ACERO INOX



Cód.	Paso	Medida mm	P.V.P. unid. €	
195776	8x8	500x130	18,11	6



RASCADOR MONOCAPA

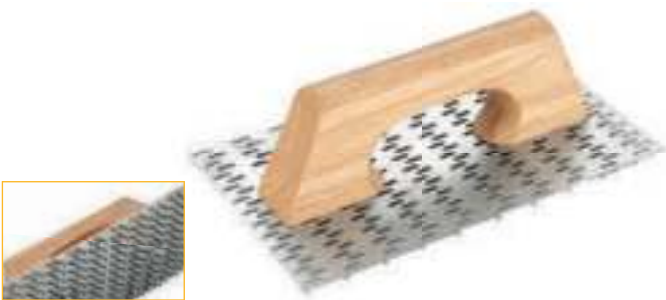

Cód.	Medida mm	P.V.P. unid. €	
195762	250x140	16,65	6



GUÍA DE ALUMINIO PARA YESERO



Cód.	Medida mm	P.V.P. unid. €	
195764	450x80	27,20	1



TALOCHA DE PLÁSTICO RECTANGULAR

11

■ Base fabricada en poliestireno.



Cód.	Medida mm	P.V.P. unid. €	
195790	270x180	5,02	6



TALOCHA DE PLÁSTICO DE PUNTA

■ Base fabricada en poliestireno.



Cód.	Medida mm	P.V.P. unid. €	
195792	270x180	5,18	6



TALOCHA DE GOMA PARA JUNTAS

- Mango fabricado en poliuretano.
- Refuerzo de aluminio en la base.

Cód.	Medida mm	P.V.P. unid. €	
195800	240x100	9,92	6





TALOCHA DE GOMA-ESPONJA

- Base 20 mm de espesor.
- Mango y base fabricados en poliuretano.

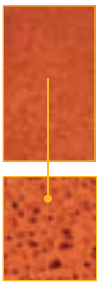

Agujeros esponja de mayor diámetro que 195796.



Cód.	Medida mm	P.V.P. unid. €	
195795	280x140	12,65	6



TALOCHA DE GOMA-ESPONJA DENSA

- Base 20 mm de espesor.
- Mango y base fabricados en poliuretano.



Agujeros esponja de menor diámetro que 195795. Esponja más densa.



Cód.	Medida mm	P.V.P. unid. €	
195796	280x140	12,67	6



TALOCHA DE ESPONJA BAJA DENSIDAD

Cód.	Medida mm	P.V.P. unid. €	
195788	280x140	7,89	6



Esponja de baja densidad.



BARRA DE DESENCOFRAR

ACERO CARBONO

- Extremos de uso templados.
- Presentación pintado.

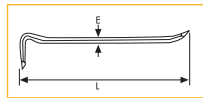

Cód.	L mm	L "	E mm	P.V.P. unid. €	
118001	500	20	20	13,80	10
118002	600	24	20	18,24	10
118003	700	28	20	20,73	10
118004	800	32	22	22,21	5
118005	900	36	22	28,63	5
118006	1000	40	22	31,06	5
118007	1200	48	22	35,94	5



11



PALANCA DESENCOFRAR LIGERA

ACERO CARBONO

- Extremos de la palanca templados.
- Presentación cromado brillante.



Cód.	L mm	L "	P.V.P. unid. €	
118010	300	12	12,40	10



FIJA DE ALBAÑIL



Cuerpo de Acero con forma redonda



Cód.	L mm	E mm	P.V.P. unid. €	
196942	250	10	5,26	12
196945	300	10	5,40	12

**LO MEJOR DE DOS
MARCAS CENTENARIAS**



Gama de tornillos de apriete fabricados en exclusiva por URKO que incorporan todos sus elementos diferenciadores: Sistema patentado de fijación entre pletina y cabeza, llanta de doble dentado y un alcance un 17% mayor que la competencia.

Además:

- Apriete a través de husillo trapezoidal para mayor fuerza.
- Émbolo encapsulado para prevenir degradar el mecanismo y provisto de bolas de rodamiento para garantizar una suavidad de funcionamiento. Guiado mediante chafalón que le confiere más estabilidad.
- Apriete terminado en cabeza hexagonal para poder ejercer más fuerza.

La gama ALYCO by Urko se completa con los puntales de expansión, únicos en el mercado ya que la capacidad de soporte que ofrecen es independiente de la apertura de los mismos.



TORNILLO DE APRIETE CON ÉMBOLO (30X8)

- 1 Cabezales de hierro fundido Nodular.
- 2 Mango en cruz y extremo hexagonal patentado por Urko.
- 3 Freno antideslizante de acero templado y dentado con autoremachado anticáida.
- 4 Llanta de acero de alta resistencia, calibrada y dentada en frío, con recubrimiento de Zinc.
- 5 Husillo con rosca trapezoidal.
- 6 Fijación cabezal-llanta mediante autoremachado patentado por Urko.

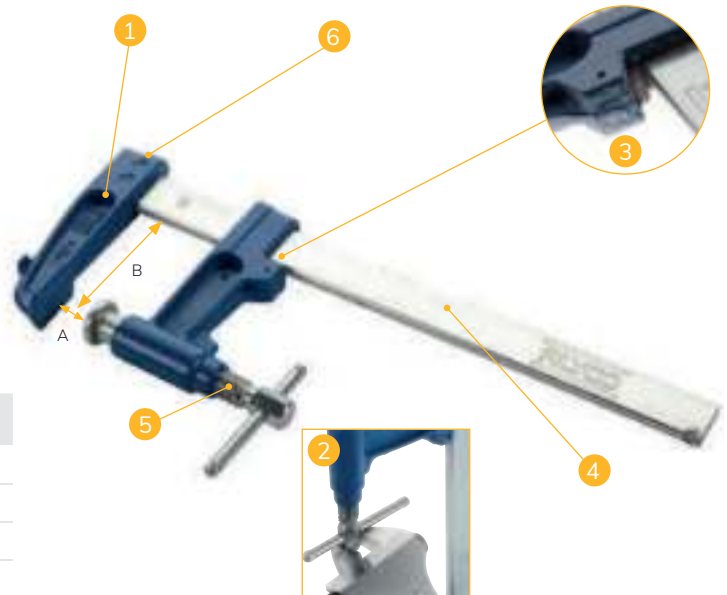

Cód	A mm	B mm	Llanta mm	Fuerza Kg	P.V.P. unid. €	
197750	200	105	30x8	900	28,20	4
197752	250	105	30x8	900	30,27	4
197753	300	105	30x8	900	32,22	4
197754	400	105	30x8	900	34,35	4
197756	600	105	30x8	900	38,04	4

11



TORNILLO DE APRIETE CON ÉMBOLO (35X8)

- Mismas características que el tornillo de apriete con émbolo (30x8).

Cód	A mm	B mm	Llanta mm	Fuerza Kg	P.V.P. unid. €	
197762	200	140	35x8	1200	33,03	4
197763	300	140	35x8	1200	36,39	4
197764	400	140	35x8	1200	39,96	4
197765	500	140	35x8	1200	42,03	4
197766	600	140	35x8	1200	44,04	4
197768	800	140	35x8	1200	47,10	4
197770	1000	140	35x8	1200	53,04	1
197772	1200	140	35x8	1200	58,81	1
197774	1400	140	35x8	1200	67,06	1





TORNILLO DE APRIETE CON ÉMBOLO (40X10)

- Mismas características que el tornillo de apriete con émbolo (30x8).

Cód	A mm	B mm	Llanta mm	Fuerza Kg	P.V.P. unid. €	
197783	300	150	40x10	1500	62,37	2
197784	400	150	40x10	1500	64,38	2
197785	500	150	40x10	1500	69,48	2
197786	600	150	40x10	1500	71,34	2
197788	800	150	40x10	1500	74,58	1
197790	1000	150	40x10	1500	78,00	1
197792	1200	150	40x10	1500	81,54	1
197794	1400	150	40x10	1500	89,75	1



SET 2 MORDAZAS MAGNÉTICAS

- Juego de 2 mordazas magnéticas para poder acoplarlas a los dos cabezales de los diferentes tornillos de apriete con émbolo (35x8).

Cód	Para llanta mm	P.V.P. unid. €	
197778	35x8	61,89	2



PUNTAL DE EXPANSIÓN

- Zapatas de alta resistencia, antideslizantes, con ángulo variable 180° y mayor seguridad, con posibilidad de fijación en ambos extremos.
- Empuñadura antideslizante.
- Sistema de bloqueo de cremallera de alta resistencia.
- Ajuste al suelo mediante varilla roscada en ambos extremos.

Cód	Apertura		Zapata mm	P.V.P. unid. €	
	Min. (cm)	Máx. (cm)			
197795	65	115	60x80	42,48	10
197796	101	177	60x80	50,76	10
197797	160	290	60x80	55,95	10
197798	195	365	60x80	67,65	10



SOPORTA
IMPACTOS FUERTES.

CARGA
GARANTIZADA
HASTA
**180
KG**



SOPORTE CON NIVEL PARA PUNTUAL DE EXPANSIÓN

- Soporte universal para niveles láser, cámaras, focos de iluminación...
- Nivel de burbujas de dos vías, tipo T.

Cód	P.V.P. unid. €	
197799	54,45	2





TORNILLO DE APRIETE CON ÉMBOLO (28X8)

- Mordazas de fundición nodular pintadas.
- Fijación de llanta y mordaza con doble remache.
- Llanta de acero calibrada y dentada por ambos lados.
- Freno dentado y templado.
- Émbolo de una pieza.
- Husillo con doble rosca trapezoidal para grandes aprietes.

Cód.	A mm	B mm	Llanta mm	Fuerza Kg	P.V.P. unid. €	
197800	200	90	28x8	400	18,33	6
197805	300	90	28x8	400	19,58	6
197810	400	90	28x8	400	22,78	6

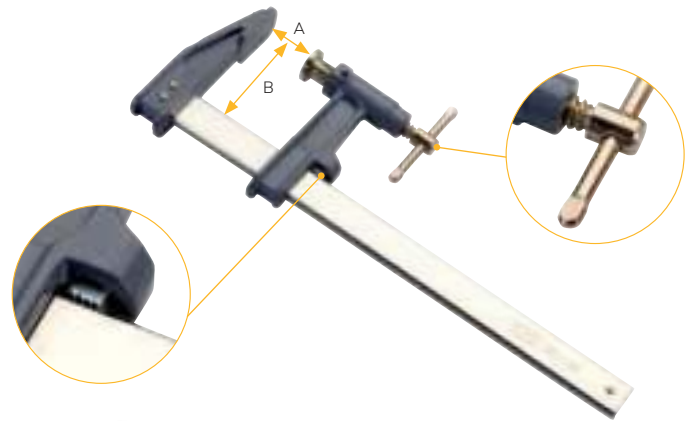

TORNILLO DE APRIETE CON ÉMBOLO (35X8)

- Mismas características que el tornillo de apriete con émbolo (28x8).

Cód.	A mm	B mm	Llanta mm	Fuerza Kg	P.V.P. unid. €	
197850	300	120	35x8	500	22,80	6
197855	400	120	35x8	500	25,81	6
197860	600	120	35x8	500	29,25	4
197865	800	120	35x8	500	32,81	4
197870	1000	120	35x8	500	35,66	2
197872	1200	120	35x8	500	39,62	2
197873	1400	120	35x8	500	47,68	2

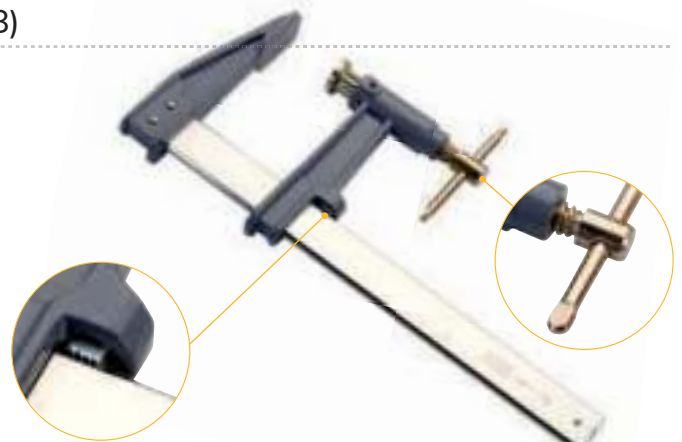

11



TORNILLO DE APRIETE CON ÉMBOLO (40X10)

- Mismas características que el tornillo de apriete con émbolo (28x8).

Cód.	A mm	B mm	Llanta mm	Fuerza Kg	P.V.P. unid. €	
197875	400	150	40x10	700	34,93	2
197877	600	150	40x10	700	39,48	2
197880	800	150	40x10	700	44,37	2
197882	1000	150	40x10	700	48,42	2

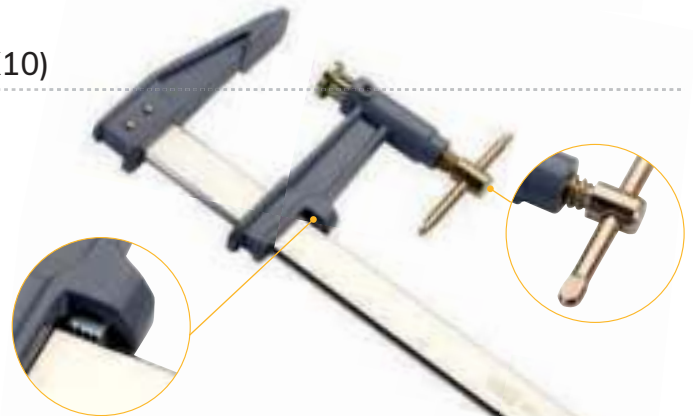

TORNILLO DE APRIETE CON HUSILLO

- Llanta de acero calibrada y dentada por ambos lados.
- Mordazas de fundición nodular pintadas.
- Mango de plástico bicomponente y ergonómico.
- Husillo con rosca trapezoidal.
- Bocas con protectores de plástico y platillo pivotante.

Cód.	A mm	B mm	Llanta mm	Fuerza Kg	P.V.P. unid. €	
197900	100	50	15x5	170	6,11	6
197905	150	50	15x5	170	6,21	6
197910	200	80	22x6	270	10,52	6
197915	300	80	22x6	270	11,17	6
197920	400	100	22x7	400	14,51	6





TORNILLO DE APRIETE CON HUSILLO



- Llanta de acero calibrada y dentada.
- Mordazas de fundición nodular.
- Mango de madera.
- Husillo con rosca trapezoidal.
- Bocas con protectores de plástico.

Cód.	A mm	B mm	P.V.P. unid. €	
171062	150	50	3,58	25
171063	200	80	5,86	12
171066	300	80	6,32	12

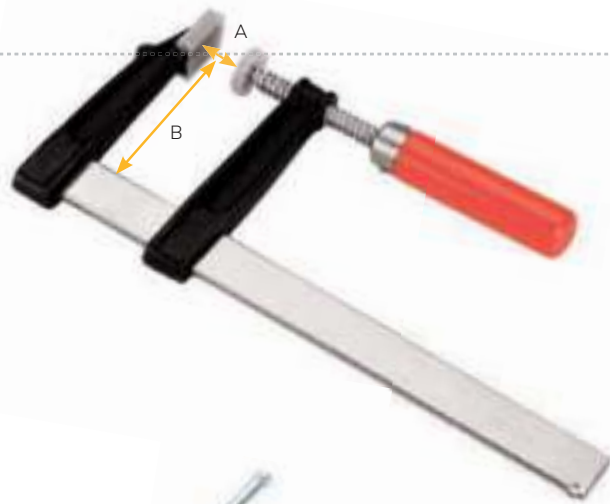

TORNILLO DE APRIETE "C"

ACERO FORJADO

Cód.	A mm	B mm	Fuerza Kg	P.V.P. unid. €	
197950	50	55	1600	19,11	4
197955	75	55	1600	24,27	4
197960	100	55	1600	30,38	4
197965	150	55	3000	49,04	4

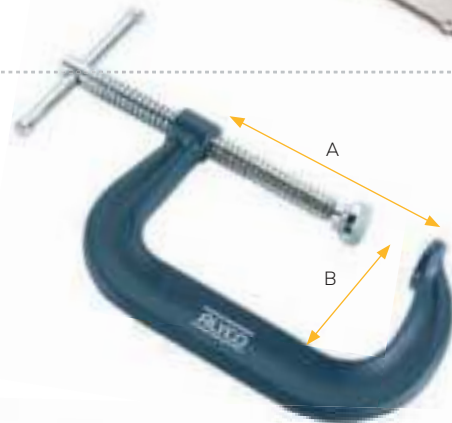

SARGENTO AUTOMÁTICO

- Palanca de desbloqueo rápido.
- Bocas recubiertas de protectores en goma blanda.
- Diseño ergonómico. Mangos bimateriales.

Cód.	Apriete mm / "	Separación mm / "	P.V.P unid. €	
198050	150 / 6	350 / 14	17,69	6
198052	300 / 12	500 / 20	18,50	6
198054	450 / 18	640 / 25,6	20,91	6



11

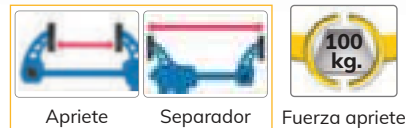

PINZA AUTOMÁTICA CON CARRACA

- Carraca fabricada en aleación de zinc.
- Diseño especial de las mordazas para realizar aprietes en piezas con formas irregulares.
- Brazos largos y delgados para llegar a zonas de difícil acceso.

Cód.	L mm	Fuerza apriete kgs.	P.V.P unid. €	
198070	135	13	3,57	12
198072	190	30	5,69	12
198074	250	43	8,77	12





LLAVE DE CARRACA PARA ANDAMIOS



EMPLEO EN MONTAJE Y DESMONTAJE DE ANDAMIOS

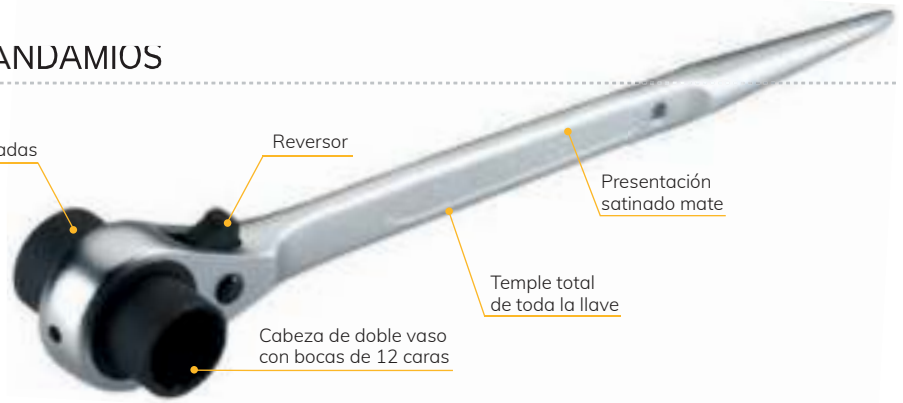

Cód.	mm	P.V.P. unid. €	
191900	19x22	50,00	2



PINZA DE PLÁSTICO

- Muelle interior. Apertura rápida y fácil de la pinza.
- Mordazas recubiertas para no dañar y realizar sujeciones de piezas con formas irregulares.



Cód.	L mm / "	Apertura máx. mm	Fuerza Kg	P.V.P unid. €	
197970	75 / 3"	35	3,8	1,15	12
197972	100 / 4"	40	9,2	1,65	12
197975	150 / 6"	62	13,0	2,56	12
197976	225 / 9"	82	22,0	3,49	12



PINZA METÁLICA

- Muelle interior para apertura rápida y fácil de la pinza.
- Mangos y bocas recubiertas de PVC.



Cód.	L mm / "	Apertura máx. mm	Fuerza Kg	P.V.P unid. €	
197985	100 / 4"	22	10	2,40	6
197986	150 / 6"	45	15	4,23	6
197987	225 / 9"	75	20	6,52	6

11



PLOMADA MAGNÉTICA

- Plomada y tornillo fabricados en Acero.
- Terminación en zincado para evitar la corrosión.
- Nuez de plástico con inserción de imán.
- Cuerda trenzada de nylon de 5 metros.



Cód.	Peso grs.	L mm	Ø mm	P.V.P unid. €	
197942	500	104	33	16,48	5
197944	750	134	33	18,27	5
197946	1000	162	33	20,10	5

Se suministra en blíster.



PLOMADA NUEZ DE MADERA

- Plomada y tornillo fabricados en Acero.
- Terminación en zincado para evitar la corrosión.
- Nuez fabricada en madera.
- Cuerda trenzada de nylon de 5 metros.



Cód.	Peso grs.	L mm	Ø mm	P.V.P unid. €	
197932	500	104	33	9,77	5
197934	750	134	33	10,76	5
197936	1000	162	33	14,74	5

Se suministra en blíster.



BOLSA DOBLE DE NYLON

- Fabricada con costuras de refuerzo.
- Con cinturón ajustable de cierre rápido.

Cód.	AxB mm	P.V.P unid. €	
196870	660x260	18,54	1

Se suministra en bolsa con colgador.

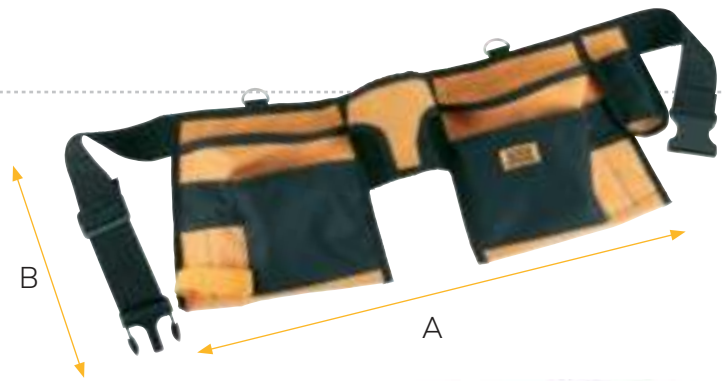

BOLSA INDIVIDUAL DE NYLON CON CINTURÓN

- Fabricada con costuras de refuerzo.
- Con cinturón ajustable de cierre rápido.

Cód.	AxB mm	P.V.P unid. €	
196875	260x260	11,21	1

Se suministra en bolsa con colgador.



BOLSA DOBLE DE CUERO

- Fabricada en cuero resistente de alta calidad.
- Costuras y remaches metálicos de refuerzo en toda la bolsa.
- Cinturón de nylon ajustable.
- Clip metálico para cinta métrica.
- Bolsillos de gran capacidad para clavos.
- 2 lazos para martillos.

Cód.	AxB mm	P.V.P unid. €	
196890	660x210	33,37	1

Se suministra en bolsa con colgador.



11



BOLSA INDIVIDUAL DE CUERO CON CINTURÓN

- Fabricada en cuero resistente de alta calidad.
- Costuras y remaches metálicos de refuerzo en toda la bolsa.
- Cinturón de nylon ajustable.
- Clip metálico para cinta métrica.
- Bolsillo de gran capacidad para clavos.

Cód.	AxB mm	P.V.P unid. €	
196894	230x210	23,48	1

Se suministra en bolsa con colgador.



BOLSA INDIVIDUAL DE CUERO

- Fabricada en cuero resistente de alta calidad.
- Costuras y remaches metálicos de refuerzo en toda la bolsa.
- Bolsillo de gran capacidad para clavos.
- 2 lazos para martillos.

Cód.	AxB mm	P.V.P unid. €	
196895	260x290	22,81	1

Se suministra en bolsa con colgador.





PORTA FLEXÓMETROS

- Posibilidad de utilizar con cinturón.
- Válidos para flexómetros de 3 y 5 metros.
- Reforzados con remaches metálicos.



Cód.	Tipo	AxB mm	P.V.P unid. €	
196898	Cuero	110x160	8,97	6
196899	Nylon	110x160	7,51	6

Se suministra en bolsa con colgador.



PORTA MARTILLOS

- Posibilidad de utilizar con cinturón.
- Aro metálico para colocar el martillo.
- Aro reforzado con remaches metálicos.



Cód.	Tipo	AxB mm	P.V.P unid. €	
196896	Cuero	200x120	6,14	6
196886	Nylon	200x120	5,85	6

Se suministra en bolsa con colgador.



CINTURÓN

- 196885: Cinturón de cuero de alta calidad y cierre metálico.
- 196897: Cinturón de nylon ajustable y cierre metálico.

Cód.	Tipo	L mm	P.V.P unid. €	
196885	Cuero	1240	15,93	6
196897	Nylon	1240	4,02	6

Se suministra en bolsa con colgador.



11



RODILLERA

- Fabricada en nylon Oxford.
- Acolchado de 20 mm en EVA y PVC.
- Correas de neopreno super flexible.
- Costuras reforzadas.

Code	AxB mm	P.V.P unid. €	
198142	230x190	22,51	1

Precio por unidad, no del par.

**ANTILÍQUIDOS
ANTIPINCHAZOS**



RODILLERA

- Fabricada en nylon Oxford.
- Relleno de 10 mm de EVA.
- Correas de neopreno super flexible.
- Costuras reforzadas.

Code	AxB mm	P.V.P unid. €	
198140	200x170	20,14	1

Precio por unidad, no del par.



12

ACCESORIOS DE PINTURA

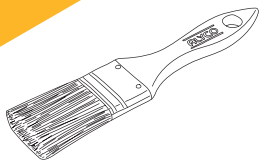

Paletina **294**

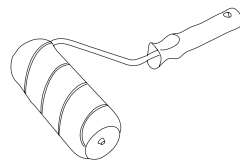

Rodillo **295**

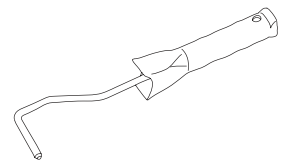

Mango plástico
mini-rodillo **296**

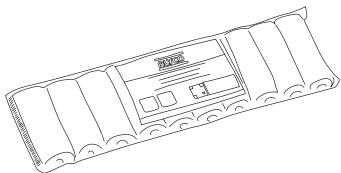

Recambio mini-rodillo **296**

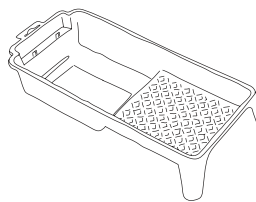

Cubeta **297**

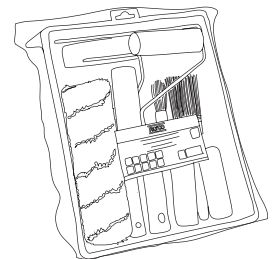

Set accesorios
de pintura **298**

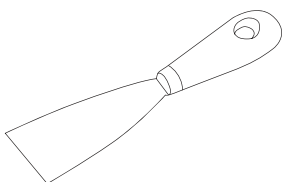

Espátula **299**

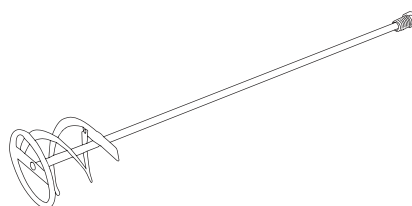

Varilla mezcladora **300**



PALETINA DOBLE ESTANDAR

- Doble capa de cerdas.
- 40% de cerdas naturales y 60% de cerdas sintéticas.
- Mango de madera de álamo.
- Virola estañada.



Cód.	A mm	L mm	P.V.P. unid. €	
187012	20	178	0,60	12
187013	30	183	0,76	12
187014	40	193	1,04	12
187015	50	200	1,36	12



PALETINA TRIPLE SINTÉTICA, MANGO DE PLÁSTICO

- Triple capa de cerdas.
- Cerdas sintéticas.
- Mango de plástico.
- Virola estañada.



Cód.	A mm	L mm	P.V.P. unid. €	
187020	20	210	0,76	12
187022	25	193	1,04	12
187023	30	210	1,20	12
187024	40	215	1,32	12
187025	50	225	1,88	12
187026	60	230	2,00	12



PALETINA TRIPLE SINTÉTICA ESPECIAL

- Triple capa de cerdas.
- Cerdas sintéticas.
- Virola inoxidable.
- Mango de madera, finamente pulida.
- Unión de las cerdas al mango mediante pegamento epoxi. Sin pérdida de cerdas.



Cód.	A mm	L mm	P.V.P. unid. €	
187032	25	220	1,56	12
187033	38	220	2,24	12
187035	50	244	3,04	12
187036	63	266	3,88	12
187037	75	260	4,52	12
187039	100	270	6,28	12



PALETINA RADIADOR

- Doble capa de cerdas.
- 30% de cerdas naturales y 70% de cerdas sintéticas.
- Mango de madera de álamo.
- Virola doblada estañada.



Cód.	A mm	L mm	P.V.P. unid. €	
187042	20	355	0,72	12
187044	40	365	1,24	12
187046	60	430	1,44	12

12



BROCHA REDONDA, CASQUILLO INOXIDABLE

- 100% cerdas naturales.
- Casquillo inoxidable.
- Mango de plástico.



Cód.	Nº	ø mm	L mm	P.V.P. unid. €	
187050	6	15	205	0,84	12
187051	8	18	215	1,08	12
187052	10	20	221	1,32	12
187053	12	23	225	1,60	12
187054	14	26	225	1,88	12
187055	16	30	235	2,24	12



PINCEL, MANGO DE MADERA

- 100% cerdas naturales.
- Tubo de aluminio con pegamento epoxi.
- Sin pérdida de cerdas.
- Mango de madera de abedul.



Cód.	Nº	A mm	L mm	P.V.P. unid. €	
187062	2	3,0	283	0,28	12
187064	4	3,5	285	0,28	12
187066	6	4,0	290	0,40	12
187068	8	4,5	291	0,44	12
187070	10	6,0	305	0,48	12
187072	12	8,5	305	0,52	12
187074	14	9,0	315	0,60	12
187076	16	9,5	315	0,64	12
187080	20	14,5	335	0,92	12



RODILLO DE POLIAMIDA

- Rodillo con mango de plástico con forma ergonómica para un fácil manejo.
- Recambios rodillo: 187137 / 187139

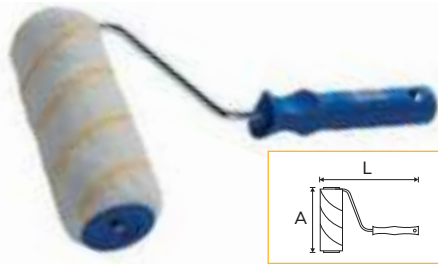

Cód.	A mm	L mm	P.V.P. unid. €	
187167	180	330	3,56	1
187169	230	340	4,12	1



RECAMBIO PARA RODILLO POLIAMIDA

- Longitud del pelo: 8 mm.
- Densidad: 1000 gr/m².
- Tejido en color blanco con franjas amarillas.
- Diámetro del tubo: 48 mm.
- Orificio para la varilla: Ø 8 mm.



Cód.	A mm	Ø mm	P.V.P. unid. €	
187137	180	60	2,04	1
187139	230	60	2,52	1



RODILLO DE LANA

- Rodillo con mango de plástico con forma ergonómica para un fácil manejo.
- Recambios rodillo: 187147 / 187149

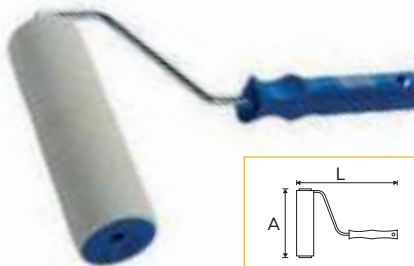

Cód.	A mm	L mm	P.V.P. unid. €	
187177	180	330	3,16	1
187179	230	340	3,60	1



RECAMBIO PARA RODILLO LANA

- Longitud de la lana: 4 mm.
- Densidad: 720 gr/m².
- Tejido mohair en color blanco.
- Diámetro del tubo: 46 mm.
- Orificio para la varilla: Ø 8 mm.

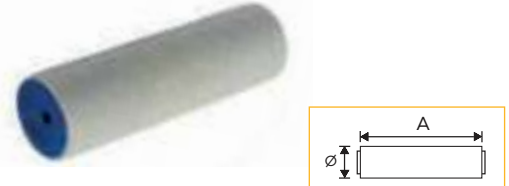

Cód.	A mm	Ø mm	P.V.P. unid. €	
187147	180	55	1,64	1
187149	230	55	2,00	1



RODILLO ACRÍLICO

- Rodillo con mango de plástico con forma ergonómica para un fácil manejo.
- Recambios rodillo: 187157 / 187159

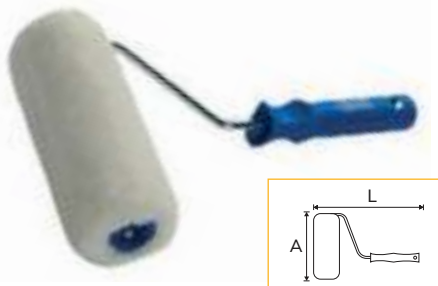

Cód.	A mm	L mm	P.V.P. unid. €	
187187	180	340	3,48	1
187189	230	350	3,92	1



RECAMBIO PARA RODILLO ACRÍLICO

- Longitud de las fibras: 12 mm.
- Densidad: 900 gr/m².
- Tejido acrílico de color blanco.
- Diámetro del tubo: 42 mm.
- Orificio para la varilla: Ø 8 mm.



Cód.	A mm	Ø mm	P.V.P. unid. €	
187157	180	70	2,08	1
187159	230	70	2,48	1



ALARGADOR PARA RODILLO

- Cuerpo de aluminio.
- Regulable a la longitud deseada.



Cód.	L min.- L máx. M	P.V.P. unid. €	
187211	1,1 - 2,0	7,36	1
187212	1,8 - 3,0	9,52	1



CUBETA PARA RODILLO

- Cubeta de plástico.
- Dispone de 2 zonas: Profunda, para almacenar la pintura. Rayada y en pendiente, para facilitar escurrir el rodillo.



Cód.	A x B x C mm	P.V.P. unid. €	
187219	350 x 280 x 65	2,44	1



RECAMBIO MINI-RODILLO ESPONJA

- Esponja de alta densidad: 50 kg/m³.
- Color blanco.
- Diámetro del tubo: 17 mm.
- Orificio para la varilla: 6,8 mm.



Cód.	A mm	ø mm	P.V.P. unid. €	
187092	50	30	4,04	1
187094	100	30	6,60	1

Unidad de venta: envase de 10 unidades.



RECAMBIO MINI-RODILLO LANA

- Longitud de la lana: 4 mm.
- Densidad: 720 gr/m².
- Tejido mohair en color blanco.
- Diámetro del tubo: 17 mm.
- Orificio para la varilla: 6,8 mm.



Cód.	A mm	ø mm	P.V.P. unid. €	
187112	50	23	3,96	1
187114	100	23	5,44	1

Unidad de venta: envase de 10 unidades.



RECAMBIO MINI-RODILLO ACRÍLICO

- Longitud de las fibras: 12 mm.
- Densidad: 850 gr/m².
- Tejido acrílico en color blanco con franjas amarillas.
- Diámetro del tubo: 17 mm.
- Orificio para la varilla: 6,8 mm.



Cód.	A mm	ø mm	P.V.P. unid. €	
187102	50	30	2,80	1
187104	100	30	3,28	1

Unidad de venta: envase de 10 unidades.



MANGO PLÁSTICO PARA MINI-RODILLO

- Fabricado en acero.
- Varilla de Ø 6 mm.
- Mango de plástico con forma ergonómica para un fácil manejo.



Cód.	A mm	L mm	P.V.P. unid. €	
187122	50	240	0,72	1
187124	100	270	0,84	1

187122: Válido para cód. 187092, 187112 y 187102.
187124: Válido para cód. 187094, 187114 y 187104.



CUBETA PARA MINI-RODILLO

- Cubeta de plástico.
- Dispone de 2 zonas: Profunda, para almacenar la pintura. Rayada y en pendiente, para facilitar escurrir el mini-rodillo.



Cód.	A x B x C mm	P.V.P. unid. €	
187214	330 x 170 x 55	0,96	1



PLÁSTICO DE PROTECCIÓN

- Plástico multiuso de 7 micras de espesor.
- Protege contra las manchas de pintura, polvo, suciedad y humedad.



IMPERMEABLE

Cód.	A x B M	P.V.P. unid. €	
187200	4 x 5	1,32	1



CINTA DE PINTOR

- Material base: Papel crepé.
- Espesor: 145 micras.
- Se adapta a superficies curvas o irregulares.
- Se quita sin dejar huella hasta 14 días.
- Para uso en interior y exterior.



Cód.	A mm	M	P.V.P. unid. €	
187190	24	25	1,16	1
187191	24	50	2,28	1
187192	48	25	2,16	1
187193	48	50	4,28	1



PAPEL DE PROTECCIÓN CON CINTA ADHESIVA

- Protección general para puertas, ventanas, marcos, zócalos, rodapiés, etc.



Cód.	A mm	M	P.V.P. unid. €	
187203	300	20	3,24	1
187204	450	20	4,60	1
187206	600	20	5,36	1

12



SET DE MINI-ACCESORIOS DE PINTURA

COMPOSICIÓN

- 1 Cubeta para mini-rodillo 100 mm (187214)
- 1 Mango de plástico para mini-rodillo 100 mm (187124)
- 1 Recambio mini-rodillo de esponja de 100 mm (187094)
- 1 Recambio mini-rodillo acrílico de 100 mm (187104)



Cód.	Piezas	P.V.P. unid. €	
187224	4	3,24	1



SET DE ACCESORIOS DE PINTURA

- 1 Cubeta para rodillo 180 mm (187219)
- 1 Mango de plástico para rodillo acrílico 180 mm (187187)
- 1 Recambio rodillo acrílico 180 mm (187157)
- 1 Paletina triple sintética 50 mm (187025)

Cód.	Piezas	P.V.P. unid. €	
187227	4	5,64	1



SET DE ACCESORIOS DE PINTURA

- 1 Cubeta para rodillo 180 mm (187219)
- 1 Recambio mini-rodillo lana 50 mm (187112)
- 1 Recambio mini-rodillo esponja 100 mm (187094)
- 1 Espátula mango madera 30 mm (196325)
- 1 Plástico de protección 4 x 5 M (187200)
- 1 Mango de plástico para mini-rodillo 50 mm (187122)
- 1 Mango de plástico para mini-rodillo 100 mm (187124)
- 1 Paletina triple sintética 50 mm (187025)
- 1 Cinta de pintor 19 mm x 45 M

Cód.	Piezas	P.V.P. unid. €	
187235	9	11,24	1



12



SET DE ACCESORIOS DE PINTURA

- 1 Mango de plástico para mini-rodillo 100 mm (187124)
- 2 Recambio mini-rodillo esponja 100 mm (187094)
- 2 Recambio mini-rodillo acrílico 100 mm (187104)
- 1 Recambio rodillo acrílico 180 mm (187157)
- 1 Brocha redonda casquillo inoxidable nº 10 (187052)
- 1 Rejilla para escurrir pintura 230 mm
- 2 Recambio mini-rodillo esponja 100 mm (187094)
- 1 Mango de plástico para rodillo acrílico 180 mm (187187)
- 1 Paletina triple sintética 50 mm (187025)
- 1 Revolvedor de pintura 230 mm
- 1 Cubeta para rodillo 230 mm (187219)

Cód.	Piezas	P.V.P. unid. €	
187230	12	7,80	1



ESPÁTULA INOXIDABLE, MANGO BIMATERIAL

ACERO INOX

- Hoja rectificada cónicamente para flexionar la punta.
- Cuerpo del mango en plástico de gran resistencia.
- Mango recubierto de elastómero antideslizante.

HOJA FLEXIBLE



Refuerzo metálico para poder golpear

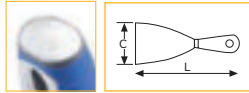

Cód.	C mm	L mm	P.V.P. unid. €	
196399	30	210	4,60	12
196401	40	220	4,73	12
196403	50	220	4,88	12
196406	60	220	5,18	12
196411	80	220	5,92	12
196416	100	220	6,64	12
196421	120	230	7,64	12
196423	150	230	9,00	12

ESPÁTULA, MANGO BIMATERIAL

ACERO CARBONO

- Hoja rectificada cónicamente para flexionar la punta.
- Cuerpo del mango en plástico de gran resistencia.
- Mango recubierto de goma blanda en zonas de contacto con la mano.

HOJA FLEXIBLE

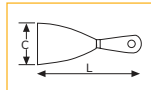

Cód.	C mm	L mm	P.V.P. unid. €	
196430	30	210	3,99	12
196440	40	210	4,19	12
196450	50	210	4,31	12
196460	60	210	4,55	12
196480	80	210	5,11	12
196490	100	220	6,37	12
196495	120	220	7,47	12
196496	150	235	7,28	12

ESPÁTULA DE EMPLASTECER, MANGO I RICOMPONENTE

ACERO INOX

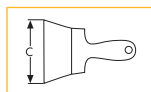

Cód.	C mm	P.V.P. unid. €	
196306	120	6,99	6
196311	140	7,21	6
196316	160	7,84	6
196318	180	8,91	6
196321	200	10,78	6

ESPÁTULA, MANGO DE MADERA

ACERO CARBONO

HOJA FLEXIBLE

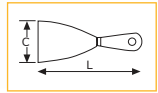

Cód.	C mm	L mm	P.V.P. unid. €	
196325	25	180	2,94	12
196340	40	190	3,12	12
196350	50	195	3,17	12
196360	60	205	3,29	12
196375	75	215	3,55	12
196385	85	220	4,02	12
196390	100	225	4,13	12
196395	120	230	4,30	12

ESPÁTULA, MANGO BIMATERIAL

ACERO CARBONO

- Hoja de acero rectificado.
- Mango bimaternal ergonómico.

HOJA FLEXIBLE

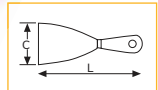

Cód.	C mm	L mm	P.V.P. unid. €	
171084	40	210	2,20	12
171086	60	210	2,51	12
171088	80	210	2,66	12
171090	100	220	2,86	12

ESPÁTULA DE EMPLASTECER, MANGO MADERA

ACERO INOX

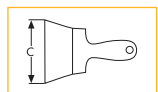

Cód.	C mm	P.V.P. unid. €	
196305	120	4,53	12
196310	140	4,95	12
196315	160	5,88	12
196320	200	6,73	12



JUEGO ESPÁTULAS PARA CARROCERO

COMPOSICIÓN

- 1 Espátula de L: 50 A: 90 mm.
- 1 Espátula de L: 75 A: 90 mm.
- 1 Espátula de L: 100 A: 90 mm.
- 1 Espátula de L: 120 A: 95 mm.

Cód.	Nº piezas	P.V.P. unid. €	
196322	4	4,42	10

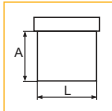



RASQUETA REFORZADA

- Cuerpo fabricado en aluminio.
- Mango en plástico ABS con gran resistencia a los golpes.
- Refuerzo metálico en la parte posterior del mango para poder golpear.
- Incluye protector de plástico.

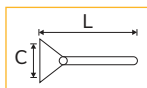

ACERO SK2



Cód.	C mm	L mm	P.V.P. unid. €	
186680	108	290	14,08	8
186685	108	390	15,40	8
HOJAS DE RECAMBIO				
186692	Envase de 10 unidades		2,22	10





RASQUETA, MANGO BIMATERIAL

- Cuerpo fabricado en polipropileno de gran resistencia.
- Mango recubierto con plástico TPR para un agarre perfecto.
- Depósito para una hoja en el mango.
- Incluye protector de plástico.

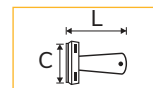

ACERO SK2



Cód.	C mm	L mm	P.V.P. unid. €	
186675	108	160	3,08	10
HOJAS DE RECAMBIO				
186692	Envase de 10 unidades		2,22	10

12



VARILLA MEZCLADORA

- Varilla hexagonal y fleje fabricados en Acero.
- Presentación pintado.
- Se suministra con colgador de goma.



Para batir pinturas, barnices, etc.

Cód.	Ø Cabeza mm	L mm	Ø mango mm	P.V.P. unid. €	
198826	60	400	8	2,83	6
198828	80	400	8	3,45	6
198830	100	600	10	5,34	6
198832	120	600	14	7,67	6



VARILLA MEZCLADORA REFORZADA

- Varilla hexagonal y fleje fabricados en Acero.
- Presentación pintado.
- Se suministra con colgador de goma.

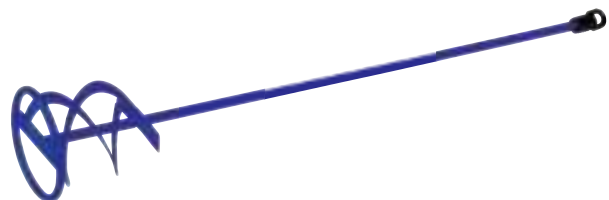

Para batir morteros y materiales muy viscosos

Cód.	Ø Cabeza mm	L mm	Conexión mango	P.V.P. unid. €	
198835	100	600	M14	13,64	6

13

FONTANERÍA Y MEDICIÓN

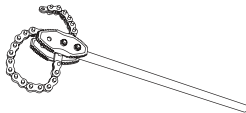

Llave de cadena **305**

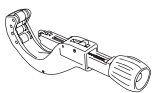

Cortatubos **307**

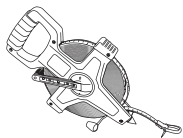

Flexómetro largo **311**

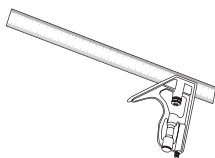

Escuadra **315**

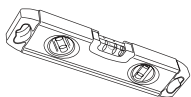

Nivel torpedo **320**



Llave de cuero **305**

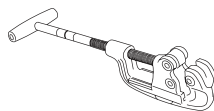

Cortatubos para acero **308**



Tiralíneas **312**

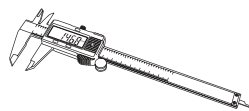

Calibre **315**

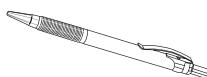

Trazador **321**



Llave Stillson **303**



Cortatubos PVC **306**



Flexómetro **310**

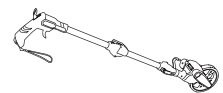

Rueda métrica **313**

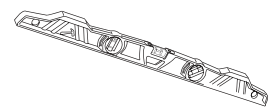

Nivel **319**

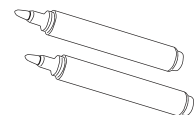

Marcador **322**



LLAVE STILLSON REFORZADA

ACERO FORJADO

Cód.	L "	L mm	Ø máx "	P.V.P. unid. €	
111212	12	300	1-1/4"	18,47	1
111214	14	350	1-1/2"	22,30	1
111218	18	450	2"	30,29	1
111224	24	600	2-1/2"	52,01	1
111236	36	900	3-1/2"	102,59	1

MODELO REFORZADO MÁS LIGERO



LLAVE STILLSON FORJADA

ACERO FORJADO

- Cabeza templada a 45 HRC, pulida.
- Dentado templado por inducción a 60 HRC.
- Presentación del cuerpo y mango pintados.

Cód.	L "	L mm	Ø máx "	P.V.P. unid. €	
111308	8	200	3/4"	12,82	1
111310	10	250	1"	15,73	1
111312	12	300	1-1/4"	18,27	1
111314	14	350	1-1/2"	21,65	1
111318	18	450	2"	28,02	1
111324	24	600	2-1/2"	47,51	1
111336	36	900	3-1/2"	96,24	1



13



LLAVE STILLSON DE ALUMINIO

ALUMINIO

- Perfil especial del mango que le da resistencia y ligereza a la llave.
- Cabeza templada a 45 HRC, pulida.
- Dentado templado por inducción a 60 HRC.
- Presentación del cuerpo y mango pintados.

Cód.	L "	L mm	Ø máx "	P.V.P. unid. €	
111410	10	250	1-1/2"	18,74	1
111412	12	300	1-3/4"	24,70	1
111414	14	350	2"	30,25	1
111418	18	450	2-1/2"	41,99	1
111424	24	600	3"	68,72	1
111436	36	900	4"	132,97	1





LLAVE STILLSON DE ALUMINIO DE AJUSTE TRANSVERSAL



- Cabeza templada a 45 HRC, pulida.
- Dentado templado por inducción a 60 HRC.
- Presentación del cuerpo y mango pintados.



Cód.	L "	L mm	Ø máx "	P.V.P. unid. €	
111415	14	350	2"	37,21	1
111419	18	450	2-1/2"	52,33	1
111425	24	600	3"	86,05	1



BOCA DE RECAMBIO PARA LLAVE STILLSON



Cód.	L "	Para Cód.	P.V.P. unid. €	
199181	8	111308	6,00	1
199184	10	111310	7,38	1
199187	12	111312	10,96	1
199190	14	111314	14,05	1
199193	18	111318	19,17	1
199196	24	111324	28,06	1
199199	36	111336	63,11	1



TUERCA DE RECAMBIO PARA LLAVE STILLSON



Cód.	L "	Para Cód.	P.V.P. unid. €	
199180	8	111308	1,79	1
199183	10	111310	2,14	1
199186	12	111312	2,85	1
199189	14	111314	3,76	1
199192	18	111318	5,02	1
199195	24	111324	7,91	1
199198	36	111336	16,86	1



LLAVE PARA TUBO COMBINADA



- Cabeza templada a 45 HRC.
- Dentado templado por inducción a 60 HRC.
- Presentación del mango y del cuerpo pintados.



Cód.	L mm	Ø máx mm/"	P.V.P. unid. €	
111375	320	25/1"	22,43	1
111380	425	40/1-1/2"	30,55	1
111385	550	50/2"	47,63	1
111390	630	75/3"	71,87	1

13



LLAVE PARA TUBO RECTA



- Cabeza templada a 45 HRC.
- Dentado templado por inducción a 60 HRC.
- Presentación del mango y del cuerpo pintados.



Cód.	L mm	Ø máx mm/"	P.V.P. unid. €	
111355	320	25/1"	21,01	1
111360	425	40/1-1/2"	28,57	1
111365	550	50/2"	44,54	1
111370	630	75/3"	68,56	1



LLAVE DE CADENA FORJADA

ACERO FORJADO

- Cabeza templada a 40 HRC.
- Dentado templado por inducción a 52 HRC.
- Presentación del cuerpo de la llave pintado.
- Anilla metálica de sujeción.

Cód.	L "	L mm	Ø máx mm	P.V.P. unid. €	
111340	12	300	150	31,99	1
CADENA DE RECAMBIO					
111341	20	para Cód. 111340		13,24	1

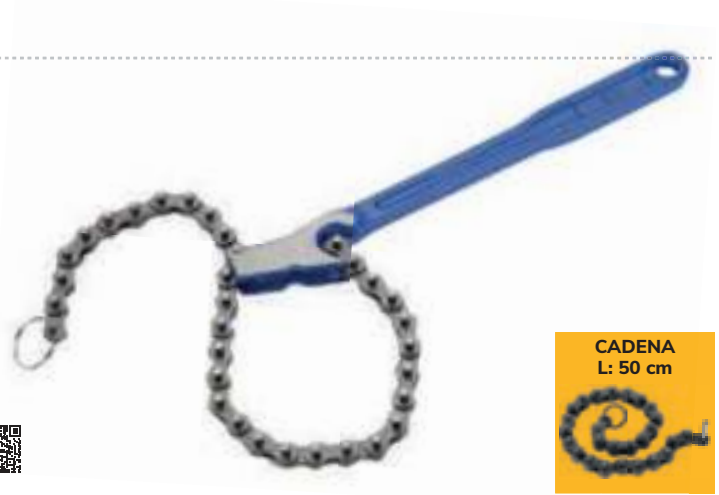

CADENA
L: 50 cm



LLAVE DE CADENA FORJADA ESPECIAL

ACERO FORJADO

- Cabeza templada a 40 HRC.
- Dentado templado por inducción a 52 HRC.
- Presentación del cuerpo de la llave pintado.
- Anilla metálica de sujeción.

Cód.	L "	L mm	Ø máx mm	P.V.P. unid. €	
111342	18	450	188	54,82	1
CADENA DE RECAMBIO					
111343	25	para Cód. 111342		22,51	1

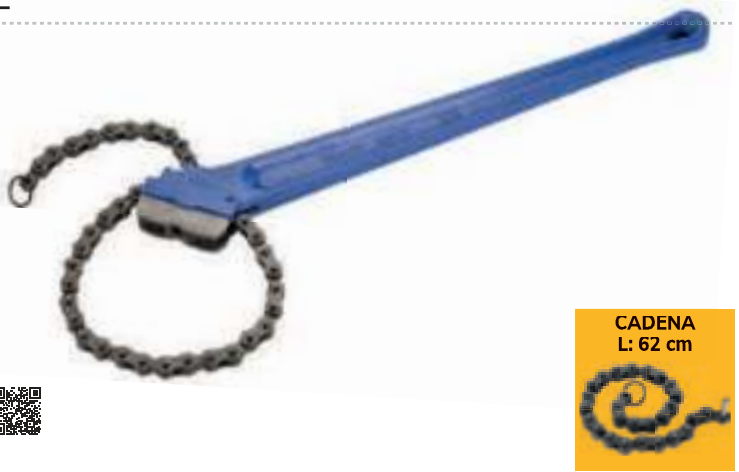

CADENA
L: 62 cm

13



LLAVE DE CADENA FORJADA LARGA

ACERO FORJADO

- Cabeza templada a 40 HRC.
- Dentado templado por inducción a 52 HRC.
- Presentación del cuerpo de la llave pintado.
- Cadena fabricada en Acero templado.
- Anilla metálica de sujeción.

Cód.	L "	L mm	L cadena mm/"	Ø máx mm	P.V.P. unid. €	
111350	24	600	730/29"	210	94,23	1
111352	36	900	850/34"	250	174,20	1
CADENA DE RECAMBIO						
111351		Para Cód. 111350			30,59	1
111353		Para Cód. 111352			48,17	1



111352



111351
111353

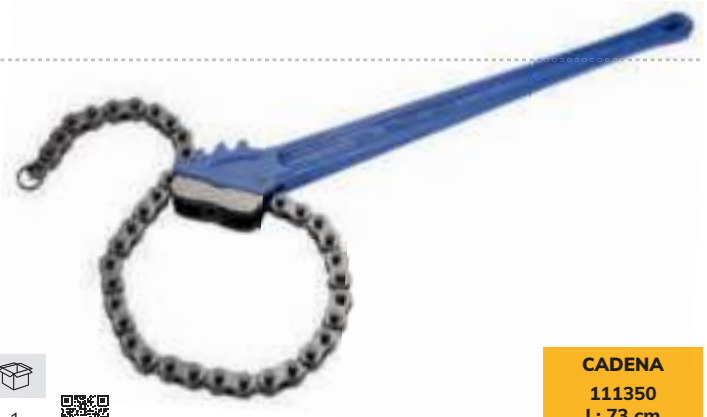

CADENA
111350
L: 73 cm
111352
L: 85 cm



LLAVE DE CADENA PARA TRABAJOS PESADOS

ACERO FORJADO

- Cabeza forjada.
- Dentado templado por inducción.
- Cabeza con mordaza reversible.
- Cadena en Acero templado.

EMPLEO EN OLEODUCTOS, GASODUCTOS Y PERFORACIONES



CADENA
111344
L: 67 cm
111346
L: 82 cm



Cód.	L "	L mm	L cadena mm/"	Ø máx mm	P.V.P. unid. €	
111344	36	900	675/27"	200	109,73	1
111346	40	1000	825/33"	240	148,43	1
CADENA DE RECAMBIO						
111345	Para Cód. 111344				44,11	1
111347	Para Cód. 111346				58,92	1



LLAVE FORJADA CON CINTA DE CUERO

ACERO FORJADO



EMPLEO EN CAMBIOS DE FILTRO DE ACEITE



CORREA
L: 53 cm

Cód.	L "	L mm	Ø máx "	P.V.P. unid. €	
111330	9	225	4"	16,90	1



LLAVE DE ALUMINIO CON CINTA DE NYLON

ALUMINIO

- Cuerpo fabricado en aluminio.
- Correa de nylon desmontable.



CORREA
L: 104 cm

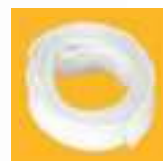

Cód.	L "	L mm	Ø máx "	P.V.P. unid. €	
111338	12	300	8"	32,56	1
CINTA DE RECAMBIO					
111339	Para Cód. 111338			14,00	1



13



TORNILLO DE BANCO PARA FONTANERO

- Cuerpo de hierro de fundición.
- Dientes templados por inducción.
- Mordaza superior móvil.
- Con agujeros para fijación.

FUNDICIÓN NODULAR

Cód.	Ø "	Ø mm	P.V.P. unid. €	
199335	2	60	66,15	1



200x325x220 mm





CORTATUBOS PVC Ø 42 MM

- Cuerpo de aluminio ligero.
- Cuchilla de Acero inoxidable en V intercambiable.
- Retorno rápido de la cuchilla.
- Seguro de cierre.
- Corte fácil debido al sistema de avance continuado sin retroceso de la cuchilla.



CAPACIDAD DE CORTE		
Tipo de tubo	Ø interior mm	Ø exterior mm
PVC	13-30	42
Polietileno	30	42
Alambre	14-26	42

Cód.	Ø mm	P.V.P. unid. €	
108260	42	51,57	1



Con soporte de plástico para corte de superficies planas a 45° y 90°

MODO DE EMPLEO

1. Preparación



Retirar el seguro del mango y abrir los mangos.

2. Corte



Colocar el tubo entre las cuchillas y apretar mangos repetidamente.

3. Avellanado



Para avellanar la zona cortada, cerrar cortatubo y utilizar según la imagen.

Se suministra en blíster



CORTATUBOS PVC Ø 27 MM

- Mismas características que 108260.
- No incluye soporte de plástico.



CAPACIDAD DE CORTE		
Tipo de tubo	Ø interior mm	Ø exterior mm
PVC	13-20	27
Polietileno	20	27
Alambre	14-20	27

Cód.	Ø mm	P.V.P. unid. €	
108250	27	31,90	1

Se suministra en blíster

13



CUCHILLAS DE RECAMBIO PARA CORTATUBOS PVC



Cuchilla muy afilada. Utilizar guantes durante el cambio de cuchilla.

Cód.	Para Cód.	P.V.P. unid. €	
108265	108260	12,22	1
108255	108250	7,45	1



Se suministra en blíster



CORTATUBOS TELESCÓPICO RÁPIDO

CAPACIDAD
Ø 6-70 mm

INCLUYE:



Cuatro rodillos (gran superficie de apoyo). Con alojamiento para tubos abocinados.

Cuchilla de corte endurecida a 58±62 HRC. Fácilmente sustituible.

Avance de cuchilla por sistema telescópico.

Palanca de soldado rápido.

Mango ergonómico de gran grosor.

Cód.	L mm	P.V.P. unid. €	
111520	220	69,01	1
CUCHILLAS DE REPUESTO			
111525	Cu-Bro-Al	5,48	10



Se suministra en blíster.

Incorpora avellanador reforzado. Muy ligero. Con alojamiento en el cuerpo del cortatubo.

Cuerpo de aluminio reforzado. Muy ligero.

Incorpora una cuchilla 111525 en el mango.



CORTATUBOS TELESCÓPICO

CAPACIDAD
Ø 3-45 mm

INCLUYE:



- Cuerpo de aluminio. Muy ligero.
- Mango ergonómico.
- 4 rodillos con alojamiento para tubos abocinados.
- Incluye avellanador en el cuerpo del cortatubo.
- Incluye cuchilla de recambio 111525 en el mango.

Cód.	L mm	P.V.P. unid. €	
111514	170	47,18	1
CUCHILLAS DE REPUESTO			
111525	Cu-Bro-Al	5,48	10



Se suministra en blíster.



13



CORTATUBOS TELESCÓPICO

CAPACIDAD
Ø 3-35 mm

INCLUYE:



- Cuerpo de aluminio. Muy ligero.
- Mango ergonómico.
- 4 rodillos con alojamiento para tubos abocinados.
- Incluye avellanador en el cuerpo del cortatubo.
- Incluye cuchilla de recambio 111525 en el mango.

Cód.	L mm	P.V.P. unid. €	
111513	140	22,48	1
CUCHILLAS DE REPUESTO			
111525	Cu-Bro-Al	5,48	10



Se suministra en blíster.





CORTATUBOS FORJADO

CAPACIDAD
Ø 12-50 mm

- Cuerpo reforzado de Acero fundido.
- 2 rodillos pulidos.
- Mango en T para facilitar el apriete y soltado.

EMPLEO EN
TUBOS DE ACERO



Cód.	L mm	P.V.P. unid. €	
111522	400	95,62	1
CUCHILLAS DE REPUESTO			
111536	Acero	14,94	1



CORTATUBOS FORJADO

CAPACIDAD
Ø 32-100 mm

- Cuerpo reforzado de Acero fundido.
- 2 rodillos pulidos.
- Mango en T para facilitar el apriete y soltado.

EMPLEO EN
TUBOS DE ACERO



Incluye barra de 300 mm para grandes esfuerzos

Cód.	L mm	P.V.P. unid. €	
111524	510	165,56	1
CUCHILLAS DE REPUESTO			
111537	Acero	22,37	1



CORTATUBOS

CAPACIDAD
Ø 3-30 mm

- Cuerpo de aluminio. Muy ligero.
- Mango ergonómico.
- 2 rodillos pulidos con alojamiento para tubos abocinados.
- Incluye avellanador.
- Incluye cuchilla de recambio en el mango.

INCLUYE:



Cuchilla recambio



Cód.	L mm	P.V.P. unid. €	
111510	150	15,41	6
CUCHILLAS DE REPUESTO			
111535	Cu-Bro-Al	3,23	10



13

Se suministra en blíster.



CORTATUBOS

CAPACIDAD
Ø 15-45 mm

- Cuerpo de aluminio. Muy ligero.
- Mango ergonómico.
- 2 rodillos pulidos.
- Incluye avellanador.
- Incluye cuchilla de recambio en el mango.

INCLUYE:



Cuchilla recambio



Cód.	L mm	P.V.P. unid. €	
111511	170	23,76	2
CUCHILLAS DE REPUESTO			
111534	Cu-Bro-Al	4,65	10



Se suministra en blíster.



MINI CORTATUBOS

- Cuerpo de aluminio.
- 2 rodillos con alojamiento para tubos abocinados.
- Incluye cuchilla 111535 para Cobre, Bronce y Aluminio.

Cód.	Ø mm	P.V.P. unid. €	
111505	3-16	10,94	1
111506	3-22	11,56	1
111507	3-28	14,62	1

CUCHILLAS DE REPUESTO

111535	Cu-Bro-Al	3,23	10
---------------	-----------	-------------	----



Se suministra en blíster.

INCLUYE:



REBARBADOR, CUERPO PLÁSTICO

- Con posibilidad de uso en dos sentidos.
- Incluye cuchilla de recambio de Acero HSS.



Cód.	L mm	P.V.P. unid. €	
111545	150	13,85	6



REBARBADOR, CUERPO METÁLICO

- Con posibilidad de uso en dos sentidos.



Cód.	L mm	P.V.P. unid. €	
111550	150	11,26	6



CUCHILLA DE RECAMBIO

Cód.	Para Cód.	P.V.P. unid. €	
111551	111545, 111550	5,85	6



13



AVELLANADOR PARA TUBOS

- 3 cuchillas fabricadas en Acero.
- Cuerpo cilíndrico de plástico duro.
- Para avellanar tubos tanto por la parte interior como la exterior, de 3 a 40 mm.

Cód.	Medida Ø mm	P.V.P. unid. €	
111540	3-40	12,55	1



Para avellanar el exterior del tubo.



Para avellanar el interior del tubo.



FLEXÓMETRO MAGNÉTICO



CLASE II

- Caja recubierta de goma antideslizante y antichoque.
- Pestaña deslizable para mediciones exteriores o interiores.
- Clip metálico en la parte posterior.
- Lazo para poder colgarlo.



Recubierta de nylon que evita el borrado



Pestaña magnética



SISTEMA ANTIBLOQUEO:

- Extracción de la cinta de forma habitual.
- Movimiento de retroceso de la cinta solo cuando se mantiene pulsado el botón.



Expositor 12 unidades (excepto 197324).

MARCADO MÉTRICA-PULGADAS



Cód.	↻ m	↻ mm	P.V.P. unid. €	📦
197307	3	16	3,96	12
197317	5	25	6,82	12



197307
197317

MARCADO MÉTRICA



Cód.	↻ m	↻ mm	P.V.P. unid. €	📦
197305	3	16	3,72	12
197315	5	25	6,20	12
197324	8	25	8,89	6



197305
197315
197324



FLEXÓMETRO



CLASE II

- 13**
- Cinta métrica en acero.
 - Caja recubierta de goma antideslizante antichoque.
 - Pestaña deslizable para mediciones exteriores-interiores.
 - Tres posiciones de frenado: bloqueo, semi-bloqueo, libre.
 - Clip metálico en la parte posterior.
 - Lazo para poder colgarlo.



Expositor 12 unidades (en 197322 y 197320 no disponible).

MARCADO MÉTRICA-PULGADAS



Cód.	↻ m	↻ mm	P.V.P. unid. €	📦
197303	3	16	3,22	12
197312	5	25	5,20	12



197303
197312

MARCADO MÉTRICA



Cód.	↻ m	↻ mm	P.V.P. unid. €	📦
197300	3	16	2,86	12
197310	5	25	5,01	12
197320	8	25	6,47	6
197322	10	25	10,07	6



197300
197310
197320
197322



FLEXÓMETRO



- Cinta de acero con marcaje de métrica.
- Con freno.
- Con clip y lazo.

CLASE II



Cód.	m	mm	P.V.P. unid. €	
170830	3	16	2,24	24
170832	5	19	3,14	12
170833	8	25	4,39	12



FLEXÓMETRO LARGO, CINTA METÁLICA



- Cinta fabricada en Acero inoxidable.
- Parte inicial de la cinta recubierta de plástico.
- Caja bimaterial ergonómica.

CLASE II



Manilla para retroceso rápido.



Sistema de sujeción de la anilla.



Cód.	m	mm	P.V.P. unid. €	
197350	20	13	17,44	1
197360	30	13	23,95	1

Se suministra en caja.



FLEXÓMETRO LARGO, CINTA FIBRA DE VIDRIO



- Cinta de fibra de vidrio recubierta de vinilo.
- Cinta marcada por ambos lados.
- Caja de flexómetro de plástico antichoque.
- Manilla en la parte frontal para retroceso rápido.
- Banda elástica para fácil manejo.

CLASE III



Anilla de plástico.

Punto 0.



Cód.	m	mm	P.V.P. unid. €	
197325	20	12,5	13,37	1
197330	30	12,5	14,54	1

Se suministra en caja.

13



FLEXÓMETRO LARGO, CINTA FIBRA DE VIDRIO



- Mango bimaterial de gran tamaño.
- Manilla para retroceso rápido de la cinta.
- Punta para la fijación del flexómetro al suelo.

CLASE III

Cinta marcada por ambos lados.

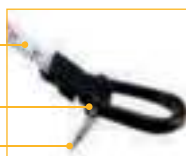

Anillo de plástico.

Punto 0.



Cód.	m	mm	P.V.P. unid. €	
197340	50	13	27,25	1



TIRALÍNEAS EN CAJA DE PLÁSTICO

- Cuerpo metálico con recubrimiento de goma exterior.
- Ventana de llenado de polvo.
- Cordón de poliéster que no deshilacha.
- Gancho de Acero especial para fijar a diferentes superficies.
- Posibilidad de bloqueo del cordón trazador (uso como plomada).

RETROCESO RÁPIDO 6:1

Cód.	P.V.P. unid. €	
196190	11,39	5

Se suministra en caja.



LONGITUD DEL CORDÓN 30 M.



JUEGO DE TIRALÍNEAS Y POLVO TRAZADOR

COMPOSICIÓN

- Tiralíneas 196190.
- Bidón de polvo trazador de 113 gr.
- Nivel de 75 mm.

Cód.	P.V.P. unid. €	
196195	12,81	4

Se suministra en blíster.



LONGITUD DEL CORDÓN 30 M.



13



POLVO TRAZADOR



Contiene dióxido de silicio (SiO₂) que puede ser dañino para la salud al ser inhalado.

- Bidón de plástico con boca especial para recarga.
- Polvo extrafino azul/rojo.

Cód.	Color	Peso grs.	P.V.P. unid. €	
196197	Azul	250	3,08	10
196199	Azul	500	5,07	6
196200	Azul	1000	7,68	4
196198	Rojo	500	5,07	6
196201	Rojo	1000	7,68	4



196197
196199
196200



196198
196201





JUEGO DE TIRALÍNEAS Y POLVO TRAZADOR



COMPOSICIÓN

- Tiralíneas con cuerda trenzada de 30 m.
- Polvo trazador azul 113 grs.
- Mininivel 75 mm.

Cód.	Nº piezas	P.V.P. unid. €	
170130	3	5,53	5

Se suministra en blíster.



LONGITUD DEL CORDÓN 30 M.



RUEDA MÉTRICA



- Rueda fabricada en poliuretano.
- Barra de Aluminio con mango de goma ergonómico.
- Botón de reset reforzado.
- Pie metálico para dejar apoyada la rueda.



CAPACIDAD MEDICIÓN MÁXIMA 10.000 M.

Cód.	P.V.P. unid. €	
197355	96,44	5

Se suministra en caja.



Ø DE LA RUEDA 300 mm.



PLEGABLE.



RUEDA MÉTRICA PLEGABLE



- Nuevo diseño del sistema de transmisión.
- Freno y controlador del marcador desde el mango.
- Botón de reset en el marcador.
- Rueda de poliuretano.
- Peso 1,1 kg.
- Muy compacta para fácil uso y transporte.



CAPACIDAD MEDICIÓN MÁXIMA 10.000 M.

Cód.	P.V.P. unid. €	
197357	115,75	5

Se suministra en caja.



Rueda centrada.



Freno y controlador del marcado.



TRIPLE PLEGADO ABIERTO: 1040 mm. CERRADO: 430 mm.



Ø DE LA RUEDA 160 mm



ESCUADRA

ACERO INOX

- Hoja fabricada en Acero inoxidable.
- Graduación de la hoja por ambos lados.
- Mango de perfil de aluminio reforzado.
- Unión remachada entre el mango y la regla.



Cód.	L x A mm	P.V.P. unid. €	
197375	250x130	9,37	6
197380	300x150	11,05	6
197385	400x180	14,33	6
197386	600x200	18,83	6

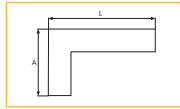

Graduación.



Unión reforzada.



Perfil reforzado.



REGLA

ACERO INOX

- Regla fabricada en Acero inoxidable.
- Regla milimetrada por ambos lados.



Cód.	L x A mm	P.V.P. unid. €	
197280	200x20	1,30	12
197281	300x25	1,50	12
197282	500x25	3,42	12

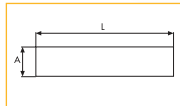

FALSA ESCUADRA

ACERO INOX

- Regla fabricada en Acero inoxidable.
- Regla milimetrada por ambos lados.
- Cuerpo reforzado de aluminio.
- Graduación angular del mango para colocar la regla al ángulo deseado.
- Tornillo de apriete-soltado de la regla. Posibilidad de regular el ángulo y la longitud.



13

Cód.	L mm	P.V.P. unid. €	
197398	250	12,21	6
197399	300	12,79	6



ESCUADRA CON MANGO DE ALUMINIO

- Hoja fabricada en Acero templado.
- Regla milimetrada por ambos lados.
- Mango de aluminio.
- Unión remachada entre el mango y la regla.



Cód.	L mm	P.V.P. unid. €	
197390	250	4,07	10
197392	300	4,65	10
197394	400	5,47	10
197396	600	7,98	10



ESCUADRA MULTIFUNCIÓN 10 EN 1

ACERO INOX

FUNCIONES:

- Regla milimetrada.
- Escuadra interior 90°.
- Escuadra exterior 90°.
- Escuadra interior 135°.
- Escuadra interior 45°.
- Nivelación horizontal.
- Nivelación vertical.
- Escuadra en T con regla deslizante.
- Medición de interiores.

Cód.	L mm	P.V.P. unid. €	
197415	300	15,12	6
197420	400	17,11	6



CALIBRE DIGITAL

ACERO INOX

- Gran pantalla LCD con botones para ajustar y fijar las cotas a medir.
- Lectura digital en mm y pulgadas + posición 0.
- Bocas de 40 mm de profundidad.
- Fijación de la lectura mediante tornillo.

Cód.	L mm	Precisión mm	P.V.P. unid. €	
197372	150	0,01	44,70	1

Se suministra en caja de plástico.



CALIBRE - PIE DE REY MONOBLOC

ACERO INOX

- Lectura en mm y pulgadas.
- Bocas de 40 mm de profundidad.
- Fijación de la lectura mediante tornillo.

Cód.	L mm	Precisión mm	P.V.P. unid. €	
197370	150	0,05	29,64	1

Se suministra en caja de plástico.



MICRÓMETRO PARA EXTERIORES

- Cuerpo de acero fundido.
- Bocas fabricadas en acero.
- Casquillo y tambor cromados.
- Freno para fijación de la lectura.

Cód.	L mm	Precisión mm	P.V.P. unid. €	
197374	0-25	0,01	23,26	1

Se suministra en caja de plástico.





KIT DE NIVEL LÁSER AUTONIVELANTE



- Nivel auto ajustable de aluminio con protección (incluye dos pilas).
- Trípode de aluminio regulable 120 cm altura.
- Placa objetivo.
- Gafas de seguridad y manual de instrucciones.

INCLUYE



2 x AA



ATENCIÓN LÁSER



USE GAFAS

LÁSER CLASE 2
TIPO λ 635 NM
ALCANCE 15 M

PRECISIÓN:



0,50 mm/m
en la línea láser



INSTRUCCIONES DE USO



APLICACIONES



Haz vertical



Haz horizontal



Haz en cruz

Cód.	P.V.P. unid. €	
196302	154,67	1



NIVEL LÁSER



- Cuerpo de aluminio con protección.
- 2 fiolas a 90° y 180°.
- Base de trabajo con ranura en "V" para tubos.

INCLUYE



2 x AAA



ATENCIÓN LÁSER



USE GAFAS

LÁSER CLASE 2
TIPO λ 650 NM

PRECISIÓN:



0,50 mm/m
Fiola horizontal

0,50 mm/m
Fiola vertical



INSTRUCCIONES DE USO



PRECISIÓN DEL LÁSER

PUNTO LÁSER MÁX 30 m ± 0,5mm/m

CRUZ LÁSER MÁX 10 m ± 1,0mm/m

Cód.	L mm	P.V.P. unid. €	
196303	400	75,00	1



13



NIVEL ANGULAR DIGITAL



- Cuerpo de aluminio con protección.
- 2 fiolas a 90° y 180°.
- Guía angular con recorrido 0°-220°.
- Lector digital con pantalla LCD con cálculo de diferencia de ángulos.
- Cambio rápido de pila.

INCLUYE



PP3

PRECISIÓN:



0,50 mm/m
Fiola horizontal

0,50 mm/m
Fiola vertical



INSTRUCCIONES DE USO

PRECISIÓN ANGULAR

RESOLUCIÓN 0,1°

PRECISIÓN ± 0,5mm/m

Cód.	L mm	P.V.P. unid. €	
196304	380	79,38	1





NIVEL TUBULAR MAGNÉTICO DE 3 FIOLAS



Imanes de 3 kg. de fuerza en la zona lateral y 5 kg. en la zona central. Imanes no visibles en el interior del nivel.



Cuerpo de aluminio con ambas superficies de apoyo fresadas para una mayor precisión.

Forma ergonómica del cuerpo del nivel.

Laterales con protección antichoque de goma.

Superficies de apoyo en V para utilizar sobre tubos.

Asas ergonómicas recubiertas de goma blanda.

PRECISIÓN:



0,50 mm/m posición normal

0,75 mm/m posición invertida

Cód.	L mm	A mm	B mm	P.V.P. unid. €	
196204	400	28	60	32,75	1
196206	600	28	60	39,34	1
196208	800	28	60	46,99	1
196210	1000	28	60	58,95	1
196212	1200	28	60	68,88	1

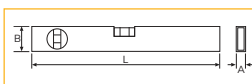

NIVEL TUBULAR MAGNÉTICO

- Cuerpo de aluminio con ambas superficies de apoyo fresadas para una mayor precisión.
- Superficie de trabajo mecanizada.
- Laterales con protección antichoque de goma.
- Tres fioles: horizontal, vertical y 45°.
- Con dos potentes imanes en la base para fiar el nivel sobre superficies metálicas.

13

Cód.	L mm	A mm	B mm	P.V.P. unid. €	
196181	400	27	52	17,30	6
196183	500	27	52	18,84	6
196185	600	27	52	20,38	6
196186	800	27	52	24,36	6
196187	1000	27	52	33,42	6
196188	1200	27	52	37,92	6

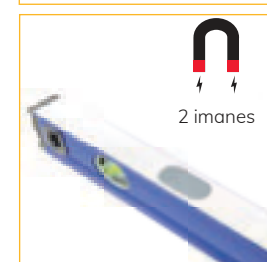
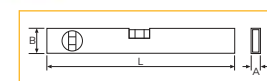

PRECISIÓN:



0,50 mm/m posición normal



NIVEL TUBULAR MAGNÉTICO



- Perfil de tubo rectangular.
- Fiolas a 0°, 45° y 90°.
- Base magnética.



Cód.	L mm	L "	P.V.P. unid. €	
171024	400	16	11,93	6
171026	600	24	14,79	6
171028	800	32	17,88	6

PRECISIÓN:



1 mm/m
posición normal



NIVEL TUBULAR

- Cuerpo de aluminio con ambas superficies de apoyo fresadas para una mayor precisión.
- Superficie de trabajo mecanizada.
- Laterales con protección antichoque de goma.
- Tres fiolas: horizontal, vertical y 45°.



Cód.	L mm	A mm	B mm	P.V.P. unid. €	
196006	400	27	52	12,44	6
196008	500	27	52	14,07	6
196011	600	27	52	15,81	6
196016	800	27	52	19,65	6
196021	1000	27	52	23,02	1
196026	1200	27	52	28,37	1

PRECISIÓN:



0,50 mm/m
posición normal

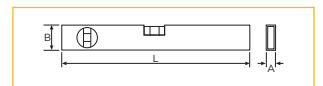

13



NIVEL TUBULAR



- Perfil de tubo rectangular.
- Fiolas a 0°, 45° y 90°.



Cód.	L mm	L "	P.V.P. unid. €	
171034	400	16	8,65	6
171036	600	24	10,79	6
171038	800	32	12,77	6
171040	1000	40	15,09	6
171044	1200	48	19,37	6

PRECISIÓN:



1 mm/m
posición normal



NIVEL TRAPEZOIDAL MAGNÉTICO DE 3 FOLAS

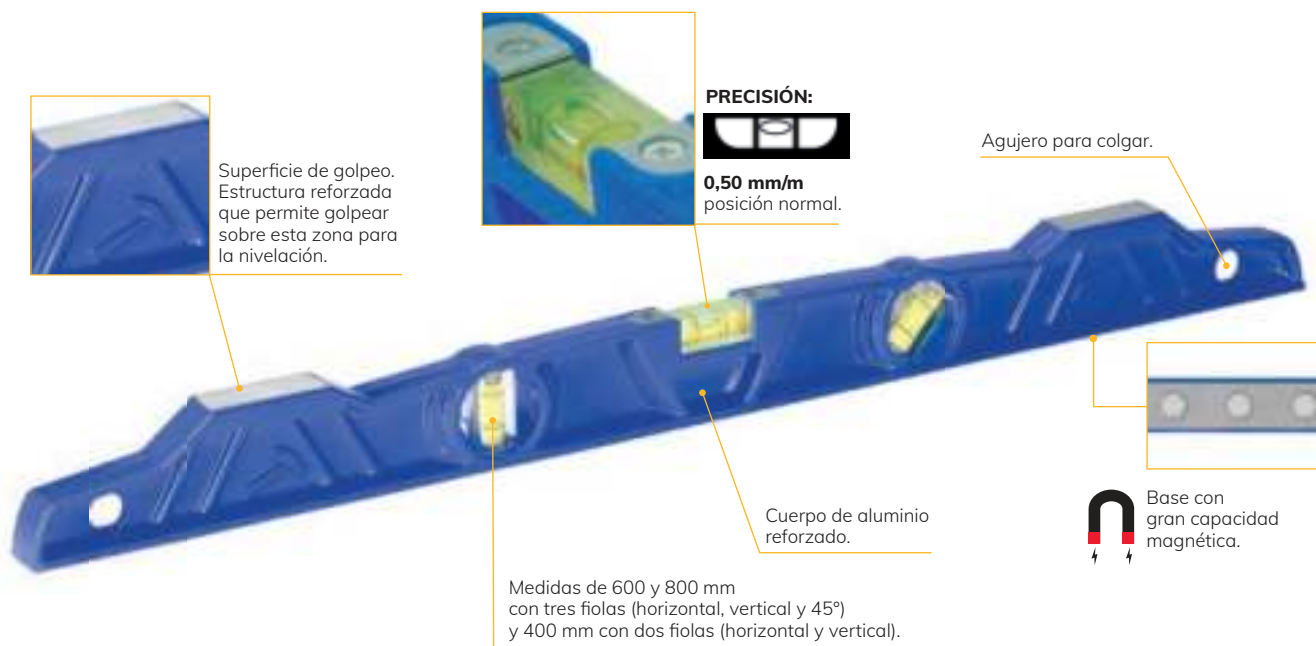

Cód.	L mm	P.V.P. unid. €	
196290	400	27,28	1
196292	600	35,73	1
196294	800	52,39	1



196290



NIVEL TRAPEZOIDAL

- Perfil en fundición inyectada de aluminio.
- Una fiola vertical y otra horizontal.
- Superficie de trabajo mecanizada.



Cód.	L mm	P.V.P. unid. €	
196280	400	12,44	6
196282	600	18,27	6

PRECISIÓN:



0,75 mm/m
posición normal

13



NIVEL TRAPEZOIDAL MAGNÉTICO

- Cuerpo aluminio fundido.
- Fiolas a 0°, 45° y 90°.
- Base magnética.



Cód.	L mm	P.V.P. unid. €	
171050	400	8,88	6
171052	600	13,30	6

PRECISIÓN:



1 mm/m
posición normal



NIVEL TORPEDO TUBULAR MAGNÉTICO

- Cuerpo de aluminio con protección antichoque.
- Base magnética con imanes interiores.
- 3 fiolas a 45°, 90° y 180°.



PRECISIÓN:



0,50 mm/m
posición normal

Cód.	L mm	P.V.P. unid. €	
196203	235	15,89	6

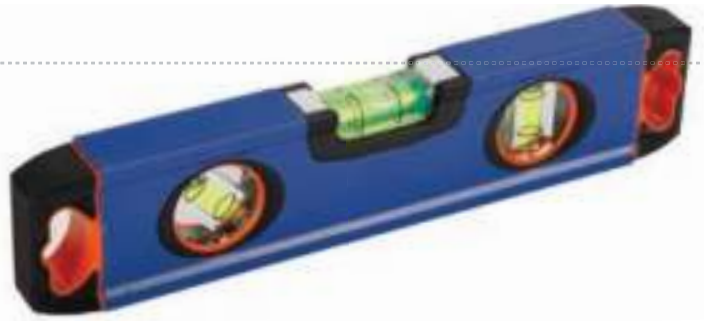

NIVEL TORPEDO TUBULAR MAGNÉTICO

- Cuerpo de plástico con agujeros para colgar.
- Base inferior magnética.
- 3 fiolas a 45°, 90° y 180°.



PRECISIÓN:



0,75 mm/m
posición normal

Cód.	L mm	P.V.P. unid. €	
196252	235	6,70	6



NIVEL TORPEDO TUBULAR MAGNÉTICO

- Cuerpo de plástico.
- Fiolas a 45°, 90° y 180°.
- Base magnética.



PRECISIÓN:



1 mm/m
posición normal

Cód.	L mm	P.V.P. unid. €	
171055	235	3,23	6



NIVEL TORPEDO TRAPEZOIDAL MAGNÉTICO

- Cuerpo de aluminio reforzado.
- 2 fiolas a 90° y 180°.



PRECISIÓN:



0,50 mm/m
posición normal

Cód.	L mm	P.V.P. unid. €	
196288	250	20,70	6



Base magnética



MINI NIVEL DE BOLSILLO CON SOPORTE

- Cuerpo de plástico.
- Base inferior magnética para nivelación horizontal.
- 1 fiola de 180°.



PRECISION:



1 mm/m
posición normal

Cód.	P.V.P. unid. €	
196255	6,87	6



Con clip para colgar



Medida: 70x20x41 mm

INCLUYE SOPORTE





GALGA DE ESPESORES



COMPOSICIÓN

0,05- 0,10- 0,15- 0,20- 0,25- 0,30- 0,35- 0,40- 0,45- 0,50- 0,55- 0,60- 0,65- 0,70- 0,75- 0,80- 0,85- 0,90- 0,95- 1,00 mm

Cód.	Nº Hojas	P.V.P. unid. €	
197362	20	6,86	6



GALGA PARA ROSCAS MÉTRICAS



COMPOSICIÓN

0,25- 0,30- 0,35- 0,40- 0,45- 0,50- 0,60- 0,70- 0,75- 0,80- 0,90- 1,00- 1,25- 1,50- 1,75- 2,00- 2,50- 3,00- 3,50- 4,00- 4,50- 5,00- 5,50- 6,00 mm

Cód.	Nº Hojas	P.V.P. unid. €	
197365	24	10,35	6



PUNZÓN CILÍNDRICO CON MANGO

ACERO CR-V



Cód.	mm	Ø mm	P.V.P. unid. €	
119132	125	6,0	5,24	12



PUNZÓN CUADRADO CON MANGO

ACERO CR-V



Cód.	mm	mm	P.V.P. unid. €	
119134	125	6,0	5,31	12



TRAZADOR

- Cuerpo en Acero al Cromo-Vanadio.
- Punta en carburo de tungsteno.



Cód.	L mm	P.V.P. unid. €	
123001	150	5,92	10



TRAZADOR ACODADO

- Cuerpo en Acero.
- Punta de Acero templado a 40-45 HRC.



ANGULO 90°

Cód.	L mm	Ø mm	P.V.P. unid. €	
123005	200	4,0	4,95	12

Se suministra en blíster.



COMPÁS DE PUNTAS

- Compás con muelle para trazado.
- Puntas templadas.
- Con tuerca para aproximaciones rápidas.

Cód.	L mm	P.V.P. unid. €	
149001	100	15,70	6
149002	150	17,13	6
149003	200	20,69	6
149004	250	22,08	6



BOTADOR PARA OCULTAR CABEZAS DE PUNTAS



Cód.	Ø "	P.V.P. unid. €	
140001	1/32	3,42	12
140002	2/32	3,42	12
140003	3/32	3,42	12
140004	4/32	3,42	12



JUEGO DE 4 BOTADORES			
140005	140001 / 140002 140003 / 140004	13,68	



PUNZÓN CENTRADOR



Cód.	Ø "	P.V.P. unid. €	
140006	1/32	3,99	12
140007	2/32	3,99	12
140008	3/32	3,99	12
140009	4/32	3,99	12

JUEGO DE 4 PUNZONES			
140010	140006 / 140007 140008 / 140009	16,59	



ROTULADOR PUNTA FINA

- Rotuladores de tinta permanente indeleble.
- Punta de 9 mm.

Cód.	L mm	Color	P.V.P. unid. €	
149081	120	Rojo	1,32	12
149086	120	Negro	1,32	12
149087	120	Azul	1,32	12



13



LÁPIZ

- Lápiz con mina de grafito.
- Cuerpo con forma ovalada.
- Se suministra sin afilar.



Cód.	L mm	P.V.P. unid. €	
149050	175	0,45	144



LÁPIZ DE 2 COLORES

- Lápiz con mina de grafito.
- Cuerpo con forma ovalada.
- Se suministra sin afilar.



Cód.	L mm	P.V.P. unid. €	
149055	175	0,58	144

14

ILUMINACIÓN Y ELECTRICIDAD

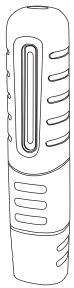

Linterna bifocal

324

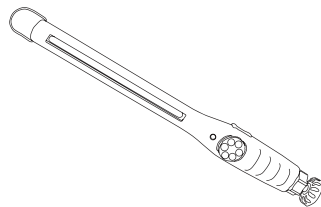

Linterna automoción

325

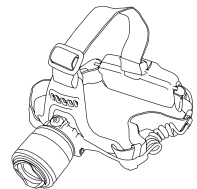

Linterna frontal

328

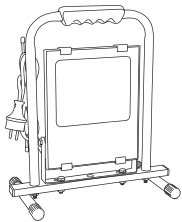

Proyector

335

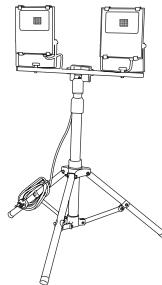

Proyector con trípode

336

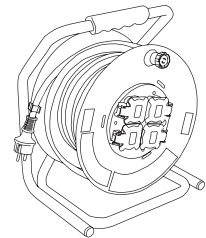

Enrollacable

337

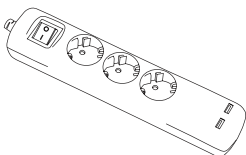

Base eléctrica

340

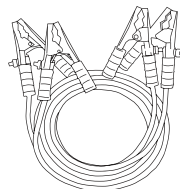

Cable de arranque

341

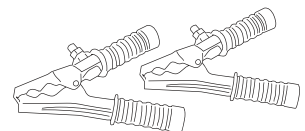

Pinzas batería

342



LINTERNA BIFOCAL RECARGABLE COB 10W

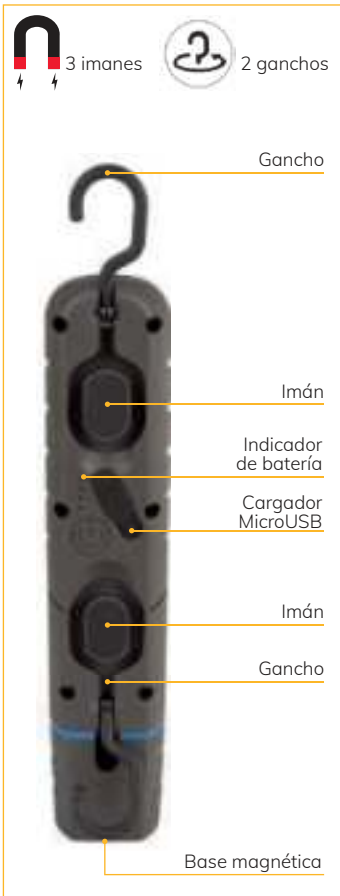

CE

3,7 V.
4000 mAh

IP65

240x45x45 mm
400 grs.

INCLUYE



Foco Superior

3 W
1 LED
150 Lumen

Foco Principal

10 W
COB
900 Lumen
Alcance 15 m



Cód.	P.V.P. unid. €	
190573	75,77	1

Se suministra en blíster.
Recambios disponibles en pág 332.

OPCIONES DE LUZ

TIEMPO CARGA	DURACIÓN
3 Horas	2 Horas

14



LINTERNA DE BATERÍA RECARGABLE COB 3W

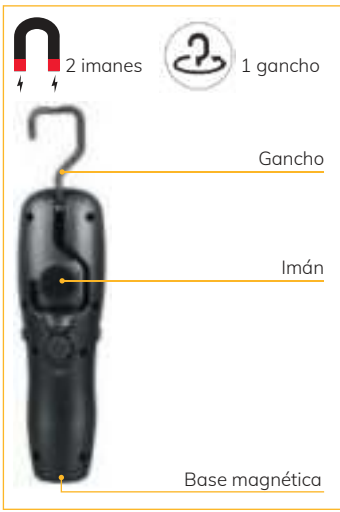

CE

3,7 V.
2200 mAh

IP20

160x40x35 mm
140 grs.



Foco Principal

3 W
COB
220 Lumen
Alcance 3 m



Batería con entrada USB para carga sin cables.



Cód.	P.V.P. unid. €	
190571	28,08	1

Se suministra en blíster.

TIEMPO CARGA	DURACIÓN
4 Horas	4 Horas



MINI LINTERNA DE ALUMINIO RECARGABLE COB 5W

224x21x19 mm
68 grs.

3,7 V.
350 mAh

CE

INCLUYE

IP54

USB C

USB



Cuerpo de aluminio + plástico ABS

Foco Superior

1 LED

60 Lumen

Foco Principal

5 W

240 Lumen

180°

Medida plegada
120x28x19 mm

Cód.	P.V.P. unid. €	
190506	46,00	1

Se suministra en caja de cartón individual.
Recambios disponibles en pág 332.



Clip metálico para colgar

OPCIONES DE LUZ



TIEMPO CARGA	DURACIÓN
2 Horas	1,5+3,5 Horas



LINTERNA DE ALUMINIO RECARGABLE COB 10W

304x32x29mm
215 grs.

3,7 V.
2600 mAh

CE

INCLUYE

IP54

USB C

USB



Cuerpo de aluminio + plástico ABS

Foco Secundario

3 W

400 Lumen

Foco Superior

1 LED

120 Lumen

180°

Medida plegada
162x38x29 mm

Cód.	P.V.P. unid. €	
190505	78,00	1

Se suministra en caja de cartón individual.
Recambios disponibles en pág 332.



OPCIONES DE LUZ



TIEMPO CARGA	DURACIÓN
4 Horas	3-8 Horas



LINTERNA EXTRAFINA RECARGABLE COB 10W

400x35x40 mm
300 grs.

3,7 V.
2600 mAh

CE

INCLUYE

IP20

micro USB

USB



ESPECIAL AUTOMOCIÓN

Longitud COB

170 mm



INSTRUCCIONES DE USO

14

Extrafina

25 mm

10 mm

Base giratoria con moleta para bloqueo



Foco Principal

10 W

400 Lumen

Alcance 5 m

Regulador intensidad

0-400 LUM

Cód.	P.V.P. unid. €	
190504	51,95	1

Se suministra en blíster.
Recambios disponibles en pág 332.



TIEMPO CARGA	DURACIÓN
5 Horas	3 Horas



LINTERNA BIFOCAL RECARGABLE COB 5W

120x50x34 mm
240 grs.

3.7 V.
2000mAh

IP54

INCLUYE

micro USB

USB

Foco Principal

5 W
COB

400 Lumen

Alcance
3 m

Foco Superior

1 LED

250 Lumen

INSTRUCCIONES DE USO

Indicador de batería.

Mosquetón para colgar.

Imán.

2 imanes.



Cód.	P.V.P. unid. €	
190539	43,89	1

Se suministra en blíster.
Recambios disponibles en pág 332.

OPCIONES DE LUZ

1 100% 2 50% 3 30% 4 100% 5 50% 6 OFF

TIEMPO CARGA DURACIÓN

4 Horas 4 Horas

Mantener pulsado unos segundos el botón de encendido para cambiar la opción de luz.



LINTERNA BIFOCAL RECARGABLE COB 4W

172x23x18 mm
56 grs.

3.7 V.
750 mAh

IP20

INCLUYE

USB C

USB

Clip metálico posterior

Foco Principal

4 W
COB

400 Lumen

Foco Superior

1 LED

150 Lumen

Cuerpo de aluminio + plástico ABS

USB C

Cód.	P.V.P. unid. €	
190537	34,00	1

Se suministra en blíster.
Recambios disponibles en pág 332.

Imán en base

OPCIONES DE LUZ

1 100% 2 100% 3 50% 4 OFF

TIEMPO CARGA DURACIÓN

2 Horas 1,5 Horas



LINTERNA BIFOCAL ABATIBLE COB-LED 2W

218x51x31 mm
230 grs.

INCLUYE

3 x AA

IP20

Foco Principal

2W
COB

200 Lumen

Foco Superior

1 LED

30 Lumen

Imán en base

Base giratoria 180°

OPCIONES DE LUZ

1 2 3 OFF

Cód.	P.V.P. unid. €	
190512	12,36	1

Se suministra en caja-expositora.



LINTERNA EXTRAFINA DE PLÁSTICO COB 3W



40x23x164 mm
70 grs.

INCLUYE
3 x AAA

Foco Principal
3 W
COB
200 Lumen

Foco Superior
1 LED
100 Lumen

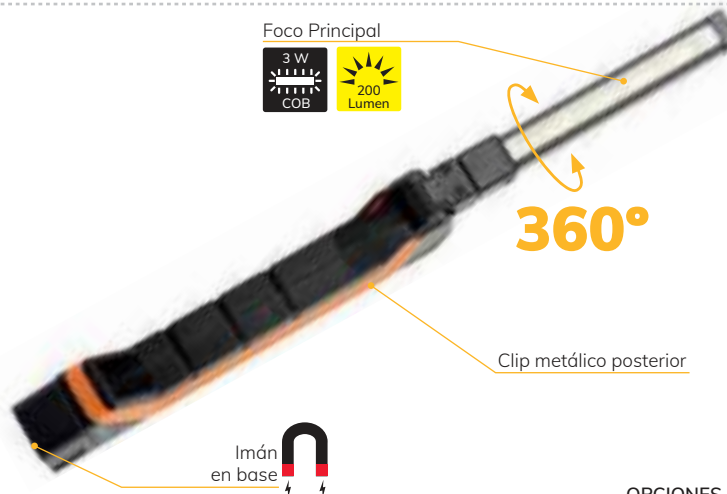

Medida plegada
165x40x25 mm



Cód.	P.V.P. unid. €	
170977	16,80	1



Se suministra en blíster.



LINTERNA BIFOCAL COB-LED 3W



195x60x30 mm
170 grs.

INCLUYE
3 x AA

Foco Principal
3W
COB
250 Lumen



Cód.	P.V.P. unid. €	
170968	8,80	12

Se suministra en caja-expositora.

Foco Superior
3 LED
30 Lumen



LINTERNA BIFOCAL COB-LED 3W



14

125x60x30 mm
105 grs.

INCLUYE
3 x AAA

Foco Principal
3W
COB
200 Lumen



Cód.	P.V.P. unid. €	
170957	6,58	12

Se suministra en caja-expositora.

Foco Superior
3 LED
30 Lumen





LINTERNA FRONTAL RECARGABLE CREE LED 12W



66x44x44 mm
285 grs.



Luz roja trasera



INSTRUCCIONES DE USO

INCLUYE



3,7 V.
2x2600 = 5200mAh

Foco Principal



Estructura de aluminio y plástico ABS.
Inclinación ajustable 90°.
Indicador de carga de batería.

Cód.	P.V.P. unid. €	
190561	44,93	1

Se suministra en caja de cartón individual.
Recambios disponibles en pág 332.

OPCIONES DE LUZ

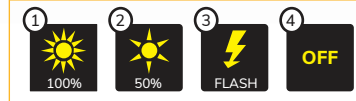

TIEMPO CARGA	DURACIÓN
4-5 Horas	2,5-8 Horas



LINTERNA FRONTAL RECARGABLE CREE LED 10W



80x73x68 mm
240 grs.



Luz roja trasera



INSTRUCCIONES DE USO

INCLUYE



3,7 V.
2x2000 = 4000 mAh

Foco Principal



Estructura de aluminio y plástico ABS.
Inclinación ajustable 90°.
Indicador de carga de batería.

OPCIONES DE LUZ

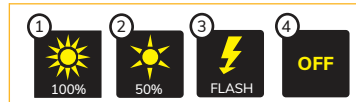

TIEMPO CARGA	DURACIÓN
4-5 Horas	2,5-8 Horas

Cód.	P.V.P. unid. €	
190562	35,72	1

Se suministra en caja de cartón individual.
Recambios disponibles en pág 332.

LINTERNA FRONTAL RECARGABLE LED 5W

90x10x80 mm
240 grs.

3,7 V.
2x1200 = 2400mAh

IP20

INCLUYE

USB C USB



4 LED
Luz roja trasera

INSTRUCCIONES DE USO

Foco Principal

ZOOM CREE LED 300 Lumen Alcance 150 m

Estructura de aluminio y plástico ABS.
Inclinación ajustable 90°.
Indicador de carga de batería.

Cód. P.V.P. unid. €

190563 24,00 1

Se suministra en caja de cartón individual.
Recambios disponibles en pág 332.

OPCIONES DE LUZ

1 100% 2 50% 3 FLASH 4 OFF

TIEMPO CARGA DURACIÓN

4 Horas 2,5 Horas

LINTERNA FRONTAL RECARGABLE FLEXIBLE COB 5W

280x70x20 mm
93 grs.

3,7 V.
1200mAh

IP44

INCLUYE

USB C USB



4 LED
Luz roja trasera

INSTRUCCIONES DE USO

Foco Principal

5 W COB 450 Lumen

Banda de nylon.
Refuerzos en plástico ABS

OPCIONES DE LUZ

1 100% 2 FLASH 3 OFF

Cód. P.V.P. unid. €

190565 19,80 1

Se suministra en caja de cartón individual.
Recambios disponibles en pág 332.

OPCIONES DE LUZ

1 100% 2 50% 3 FLASH 4 OFF

TIEMPO CARGA DURACIÓN

1,5-3 Horas 3 Horas

LINTERNA FRONTAL 10 LED

70x50x50 mm
66 grs.

INCLUYE

3 x AAA

Foco Principal

10 LED 20 Lumen Alcance 10 m



Estructura de plástico ABS.
Inclinación ajustable 180°.

Cód. P.V.P. unid. €

190568 7,31 10

Se suministra en blíster.

OPCIONES DE LUZ

1 100% 2 50% 3 FLASH 4 OFF



FOCO 3 LED RECARGABLE 10W

152x170x95 mm
440 grs.

INCLUYE



3,7 V.
2x2200 = 4400mAh



Mango ergonómico

Estructura de policarbonato, plástico ABS y goma antideslizante.

Lazo ajustable para colgar



INSTRUCCIONES DE USO

Cód.	P.V.P. unid. €	
190551	66,40	1

Se suministra en caja de cartón individual. Recambios disponibles en pág. 332.

OPCIONES DE LUZ

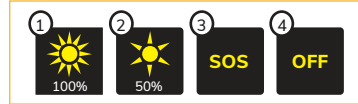

TIEMPO CARGA	DURACIÓN
4-5 Horas	3-6 Horas



LÁMPARA DE INSPECCIÓN DE MOTOR SMD 15W

1280x195x80 mm
1700 grs.



CUERPO EXTENSIBLE
127 - 210 CM



Ganchos recubiertos de goma para no dañar el capot.



INSTRUCCIONES DE USO

Cód.	P.V.P. unid. €	
190574	108,05	1

Se suministra en caja de cartón individual.

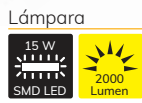

14



LÁMPARA PORTÁTIL DE OBRA

100x100x390 mm
800 grs.



TIPO DE PROTECCIÓN
CLASE II

No incluye bombilla.



Colgador metálico

Reflector metálico.

Soporte de la bombilla E27. Casquillo cerámico.

Mango ergonómico de goma antideslizante



INSTRUCCIONES DE USO

Cód.	P.V.P. unid. €	
190535	21,18	1

Se suministra en bolsa con colgador.

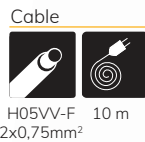



LINTERNA TUBULAR RECARGABLE DE ALUMINIO LED 10W

158x39x39 mm
221 grs.

3,7 V.
2600mAh

CE

INCLUYE

IP54



Foco Principal

10 W
CREE LED

800 Lumen

Alcance
250 m



Cód.	P.V.P. unid. €	
190578	50,00	1

Se suministra en caja de cartón individual.
Recambios disponibles en pág. 332.

OPCIONES DE LUZ

1 100% 2 50% 3 OFF

TIEMPO CARGA	DURACIÓN
4-5 Horas	2-3 Horas



LINTERNA TUBULAR RECARGABLE DE ALUMINIO LED 20W

225x43x43 mm
328 grs.

3,7 V.
4400mAh

CE

INCLUYE

IP54



Foco Principal

20 W
CREE LED

1500 Lumen

Alcance
250 m



Cód.	P.V.P. unid. €	
190579	67,80	1

Se suministra en caja de cartón individual.
Recambios disponibles en pág. 332.

OPCIONES DE LUZ

1 100% 2 50% 3 OFF

TIEMPO CARGA	DURACIÓN
4-5 Horas	2-3 Horas



LINTERNA DE ALUMINIO 9 LEDS

90x25x25 mm
67 grs.

INCLUYE

3 x AAA

CE



Cód.	L mm	P.V.P. unid. €	
170955	90	4,80	12

Se suministra en caja-expositora.

Foco Principal

9 LED 36 Lumen





LINTERNA TUBULAR DE ALUMINIO LED

27x27x172 mm
130 grs.

INCLUYE
4 x LR44

Cuerpo de aluminio

Imán en base

Imán capacidad 1,25 kg

Ø 27 mm

Foco Principal
0,5W
1 LED
20 Lumen

Cód.	P.V.P. unid. €	
190570	11,72	12

EXTENSIBLE	
	170 mm
	565 mm

Se suministra en blíster.



LINTERNA TUBULAR DE ALUMINIO LED

195x20x20 mm
76 grs.

INCLUYE
3 x LR44

Ø 20mm

Imán capacidad 3 kg

Cód.	P.V.P. unid. €	
190960	5,42	12

EXTENSIBLE	
	195 mm
	805 mm

Se suministra en caja-expositora.



LINTERNA RECARGABLE COB 30W

520x50x40 mm
495 grs.

3,7 V.
5200mAh

INCLUYE
Regulador intensidad

Foco Principal
30 W
COB
1500-3000 Lumen
3000 Lumen

360°

180°

Gancho

Indicador de carga

INSTRUCCIONES DE USO

TIEMPO CARGA DURACIÓN
4 Horas 2 Horas

Cód.	P.V.P. unid. €	
190583	94,00	1

Se suministra en caja de cartón individual.
Recambios disponibles en pág. 332.

RECAMBIOS PARA LINTERNAS Y FOCOS

Foto.	Cod.	Tipo / Descripción	Para Cód.	P.V.P. unid. €	
	190553	CABLE DE RECARGA: Entrada USB-MicroUSB (1metro)	190504 / 190539 / 190561 190562 / 190573	3,31	1
	190554	CABLE DE RECARGA: Entrada USB-USB tipo C (1metro)	190505 / 190506 / 190537 190563 / 190565 / 190578 190579 / 199227	3,31	1
	190556	CABLE DE RECARGA: Entrada USB tipo A - CC 5V redondo C (1metro)	190551 / 199220 / 199222 199233 / 199238 / 199277	3,31	1
	190558	BATERÍA: Lítio: 3,7 V - 1200 mAh	190561 / 190562 / 190563 190578 / 190579	9,75	1
	190559	ENCHUFE CARGADOR USB: Entrada: CA 100 - 240 V Salida USB: CC 5 V -1A	190504 / 190505 / 190506 190537 / 190539 / 190551 190561 / 190562 / 190563 190565 / 190573 / 190578 190579 / 190583 / 199220 199222 / 199227	5,73	1



PROYECTOR FINO RECARGABLE SMD 50W

250x72x320 mm
1560 grs.



INSTRUCCIONES DE USO



7,4 V.
11000mAh



Amplia asa para fácil transporte

Estructura del proyector en aluminio y plástico ABS

Soporte de proyector en hierro

Refuerzos de plástico en las esquinas



Cód.	P.V.P. unid. €	
199238	166,00	1

Se suministra en caja de cartón individual.
Recambios disponibles en pág. 332.



PROYECTOR FINO RECARGABLE SMD 30W

220x72x272 mm
1250 grs.



INSTRUCCIONES DE USO



7,4 V.
6600mAh

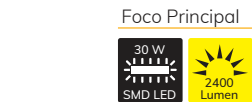

MISMAS CARACTERÍSTICAS QUE CÓD. 199238



Cód.	P.V.P. unid. €	
199233	118,00	1

Se suministra en caja de cartón individual.
Recambios disponibles en pág. 332.



PROYECTOR FINO RECARGABLE SMD 20W

180x72x272 mm
1250 grs.



INSTRUCCIONES DE USO



3,7 V.
6600mAh

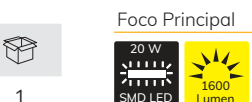

MISMAS CARACTERÍSTICAS QUE CÓD. 199238



Cód.	P.V.P. unid. €	
199227	86,00	1

Se suministra en caja de cartón individual.
Recambios disponibles en pág. 332.



FOCO DE BATERÍA RECARGABLE COB 20W

190x135x47 mm
840 grs.



3,7 V.
6600 mAh



Indicador de carga de batería

Foco Principal



Salida USB 5V-1A para carga de dispositivos externos: teléfonos móviles, tablets, GPS, drones...



INSTRUCCIONES DE USO

ASA MAGNÉTICA

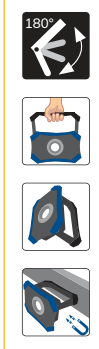

Cód.	P.V.P. unid. €	
199222	99,08	1

Se suministra en caja de cartón individual.
Recambios disponibles en pág. 332.

OPCIONES DE LUZ



TIEMPO CARGA DURACIÓN



FOCO DE BATERÍA RECARGABLE COB 10W

170x126x42 mm
430 grs.



3,7 V.
4400 mAh

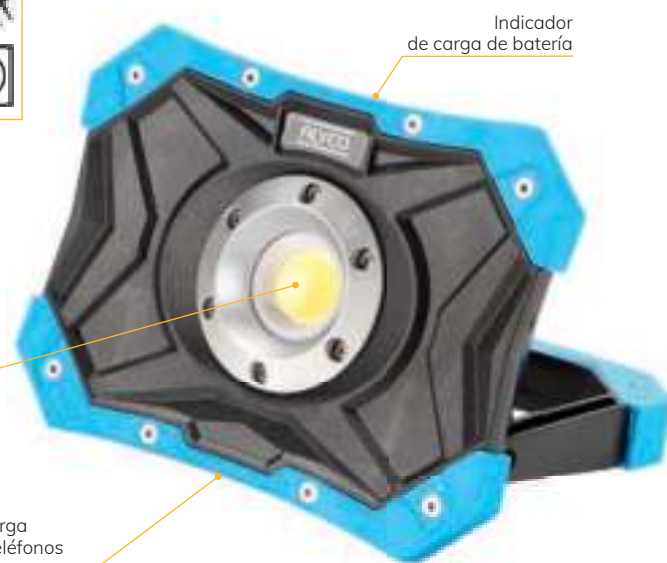

Indicador de carga de batería

Foco principal



Salida USB 5V-1A para carga de dispositivos externos: teléfonos móviles, tablets, GPS, drones...



INSTRUCCIONES DE USO

ASA MAGNÉTICA



Cód.	P.V.P. unid. €	
199220	60,34	1

Se suministra en caja de cartón individual.
Recambios disponibles en pág. 332.

OPCIONES DE LUZ



TIEMPO CARGA DURACIÓN





PROYECTOR SMD 50W

- Carcasa de aluminio extrafina.
- Marco de acero resistente.
- Vidrio templado grueso.
- Temperatura de trabajo: -20°+50°.

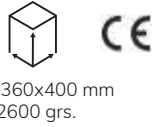

INSTRUCCIONES DE USO

CABLE



H05RN-F 3x1mm² 1,5 m



Clase energética

Cód. P.V.P. unid. €

199235 91,36 1

Se suministra en caja de cartón individual.



PROYECTOR SMD 30W

- Carcasa de aluminio extrafina.
- Marco de acero resistente.
- Vidrio templado grueso.
- Temperatura de trabajo: -20°+50°.

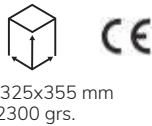

INSTRUCCIONES DE USO

CABLE



H05RN-F 3x1mm² 1,5 m



Clase energética

Cód. P.V.P. unid. €

199230 76,75 1

Se suministra en caja de cartón individual.



PROYECTOR SMD 20W

- Carcasa de aluminio extrafina.
- Marco de acero resistente.
- Vidrio templado grueso.
- Temperatura de trabajo: -20°+50°.



INSTRUCCIONES DE USO

CABLE



H05RN-F 3x1mm² 1,5 m



Clase energética

Cód. P.V.P. unid. €

199225 49,65 1

Se suministra en caja de cartón individual.

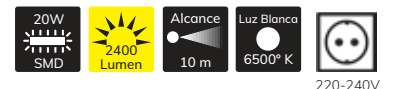





2 PROYECTORES LED CON TRÍPODE

- Carcasa de aluminio extrafina.
- Trípode de acero resistente.
- Vidrio templado grueso.
- Temperatura de trabajo: -20°/+50°.

 **CE**
725x725x180 mm
5000 grs.



CABLE

H05RN-F 3x1mm² 3 m

Cód.	P.V.P. unid. €	
199228	119,38	1

Se suministra en caja de cartón individual.

 **IP65**

 **A+**
Clase energética

Templado  Extrafino  50 mm
Inclinable  130° Trípode telescópico 
Máx: 158 cm
Mín: 67 cm

20W  SMD **x2** 2400  Lumen **x2** Alcance  20 m Luz Blanca  6500° K  220-240V





PROYECTOR SMD 60W

- Carcasa de aluminio.
- Marco de acero resistente.
- Vidrio templado grueso.
- Temperatura de trabajo: -20°/+50°.

 **CE**
298x188x305 mm
1600 grs.



CABLE

H05RN-F 3x1mm² 1,5 m

Cód.	P.V.P. unid. €	
199237	82,00	1

Se suministra en caja de cartón individual.

 **IP65**

Foco Principal  60 W SMD LED  6000 Lumen

Templado  Inclinable  190°
Asa abatible  Luz Blanca  6500° K  220-240V





PROYECTOR SMD 30W

- Carcasa de aluminio.
- Marco de acero resistente.
- Vidrio templado grueso.
- Temperatura de trabajo: -20°/+50°.

 **CE**
215x188x265 mm
1100 grs.



CABLE

H05RN-F 3x1mm² 1,5 m

Cód.	P.V.P. unid. €	
199232	58,00	1

Se suministra en caja de cartón individual.

 **IP65**

Foco Principal  30 W SMD LED  3000 Lumen

Templado  Inclinable  130°
Asa abatible  Luz Blanca  6500° K  220-240V



ENROLLACABLES DE ALTA SEGURIDAD

3 hilos x 1,5 mm² CABLE COBRE

- Base y soporte de la empuñadura metálicas.
- Carrete fabricado en plástico de gran resistencia.
- Bases para enchufe con dispositivo térmico de seguridad (botón rojo). Incluye 3 bases.
- Manivela para enrollar y desenrollar el cable.
- Empuñadura con protector de goma antideslizante.



Cu

CABLE 1,5 MM²



TIPO DE CABLE: H05RR-F 3G



MAX. 1000W - 230 V - 4,4 A

MAX. 3000W - 230 V - 13 A



290x210x365 mm
199403: 4 kgs.
199428: 7 kgs.

PROTECCIÓN CONTRA LA INTEMPERIE

- Protección 5 contra el polvo: objetos con diámetro mayor a 1 mm.
- Protección 5 contra el agua proyectada en todas las direcciones.

Cód.	L m	P.V.P. unid. €	
199403	20	78,73	1
199428	40	134,59	1

Se suministra en caja de cartón individual.



ENROLLACABLES DE ALTA SEGURIDAD

3 hilos x 2,5 mm² CABLE COBRE

- Base y soporte de la empuñadura metálicas.
- Carrete fabricado en plástico de gran resistencia.
- Bases para enchufe con dispositivo térmico de seguridad (botón rojo).
- Manivela para enrollar y desenrollar el cable.
- Empuñadura con protector de goma antideslizante.



Cu

CABLE 2,5 MM²



TIPO DE CABLE: H07RN-F 3G



MAX. 1300W - 230 V - 5,6 A

MAX. 3600W - 230 V - 15,6 A



222x300x390 mm
199401: 8 kgs.
199426: 13 kgs.

Cód.	L m	P.V.P. unid. €	
199401	25	146,46	1
199426	40	205,56	1

Se suministra en caja de cartón individual.



ENROLLACABLES CON TAPAS DE SEGURIDAD

3 hilos x 1,5 mm² CABLE COBRE

- Base y soporte de la empuñadura metálicas.
- Carrete fabricado en plástico de gran resistencia.
- Bases para enchufe con dispositivo térmico de seguridad (botón rojo).
- Manivela para enrollar y desenrollar el cable.
- Empuñadura con protector de goma antideslizante.



CON TAPAS



TIPO DE CABLE: H05VV-F 3G

MAX. 1000W - 230 V - 4,3 A

MAX. 3000W - 230 V - 13 A



200x260x340 mm
199405 - 4 kgs.
199430 - 7 kgs.

Cód.	L m	P.V.P. unid. €	
199405	25	70,36	1
199430	50	115,69	1

Se suministra en caja de cartón individual.



ENROLLACABLES

3 hilos x 1,5 mm² CABLE COBRE

- Base y soporte de la empuñadura metálicas.
- Carrete fabricado en plástico de gran resistencia.
- Bases para enchufe con dispositivo térmico de seguridad (botón rojo).
- Manivela para enrollar y desenrollar el cable.
- Empuñadura con protector de goma antideslizante.



TIPO DE CABLE: H05VV-F 3G

MAX. 1000W - 230 V - 4,3 A

MAX. 3000W - 230 V - 13 A



200x260x340 mm
199400 - 4 kgs.
199425 - 6 kgs.

Cód.	L m	P.V.P. unid. €	
199400	25	62,02	1
199425	50	112,00	1

Se suministra en caja de cartón individual.



14



ENROLLACABLES

3 hilos x 1,0 mm² CABLE COBRE

- Carrete fabricado en plástico de gran resistencia.
- Bases para enchufe con dispositivo térmico de seguridad (botón rojo).

TIPO DE CABLE: H05VV-F



MAX. 1000W - 230 V - 4,3 A

MAX. 3000W - 230 V - 10 A



Cód.	L m	P.V.P. unid. €	
199409	5	18,52	5
199410	10	27,76	5
199415	15	34,31	5

Se suministra en caja de cartón.



PROLONGADOR DE CABLE PARA EXTERIOR

3 hilos x 1,5 mm² CABLE COBRE

- Prolongador con sistema de protección infantil.
- Cable recubierto de PVC.
- Cable bipolar + tierra.

TIPO DE CABLE: H05VV-F



MAX. 3680W - 230 V - 16 A



Cód.	L m	P.V.P. unid. €	
199416	15	38,02	1
199417	25	53,79	1



PROLONGADOR DE CABLE

3 hilos x 1,5 mm² CABLE COBRE

- Prolongador con sistema de protección infantil.
- Cable recubierto de PVC.
- Cable bipolar + tierra.

TIPO DE CABLE: H05VV-F



MAX. 3680W - 230 V - 16 A



14



Cód.	L m	P.V.P. unid. €	
199472	2	7,74	1
199473	3	9,79	1
199474	4	11,92	1
199475	5	14,39	1





BASE MÚLTIPLE DE ENCHUFES + USB

3 hilos x 1,5 mm² CABLE COBRE

- Base múltiple con sistema de protección infantil.
- Interruptor manual con avisador óptico.
- Cable bipolar + tierra 3G.



LONGITUD CABLE 1,40 M



Cu

TIPO DE CABLE: H05VV-F



MAX. 3680W - 230 V - 16 A



SEGURIDAD



2 TOMAS USB
2100 mA - 5V DC



Cód.	Nº enchufes	P.V.P. unid. €	
199433	3	17,06	1
199435	5	18,72	1
199436	6	19,67	1



BASE MÚLTIPLE DE ENCHUFES CON INTERRUPTOR

3 hilos x 1,5 mm² CABLE COBRE

- Base múltiple con sistema de protección infantil.
- Base con interruptor manual con avisador óptico.
- Cable bipolar + tierra 3G.



LONGITUD CABLE 1,40 M Y 3 M



Cu

TIPO DE CABLE: H05VV-F



MAX. 3680W - 230 V - 16 A



SEGURIDAD



Cód.	Nº enchufes	L cable m	P.V.P. unid. €	
199463	3	1,4	7,82	1
199464	4	1,4	8,35	1
199465	5	1,4	8,86	1
199466	6	1,4	9,54	1
199443	3	3,0	10,83	1
199444	4	3,0	11,21	1
199445	5	3,0	11,59	1
199446	6	3,0	12,10	1

14



BASE MÚLTIPLE DE ENCHUFES

3 hilos x 1,5 mm² CABLE COBRE

- Base múltiple con sistema de protección infantil.
- Cable bipolar + tierra 3G.



LONGITUD CABLE 1,40 M



Cu

TIPO DE CABLE: H05VV-F



MAX. 3680W - 230 V - 16 A



SEGURIDAD



Cód.	Nº enchufes	P.V.P. unid. €	
199453	3	6,11	1
199454	4	6,67	1
199455	5	6,82	1
199456	6	7,39	1

 CABLE DE ARRANQUE DE COBRE DE 3,5M

PINZA
199370  **BRONCE**
160x100 mm



CABLE
Longitud 3,5 M  **Cu 100%**
Sección 35 mm²



Cód.	P.V.P. unid. €	
199375	157,83	1

Se suministra en bolsa.



 CABLE DE ARRANQUE DE COBRE DE 3,5M

PINZA
185X120 mm  **ACERO BRONCE**



CABLE
Longitud 3,5 M  **Cu 100%**
Sección 25 mm²



Cód.	P.V.P. unid. €	
199377	73,05	1

Se suministra en bolsa.



 CABLE DE ARRANQUE DE COBRE-ALUMINIO DE 3 M

PINZA
190X130 mm  **ACERO ZINC**



CABLE
Longitud 3 M  **Cu Al**
Sección 35 mm²



Cód.	P.V.P. unid. €	
199382	27,25	4

Se suministra en bolsa.



14

 CABLE DE ARRANQUE DE COBRE-ALUMINIO DE 2,5 M

PINZA
190X130 mm  **ACERO ZINC**



CABLE
Longitud 2,5 M  **Cu Al**
Sección 25 mm²



Cód.	P.V.P. unid. €	
199380	20,76	5

Se suministra en bolsa.





JUEGO DE 2 PINZAS DE BATERÍA DE BRONCE

- Cuerpo macizo de bronce.
- Con tornillo para sujeción de cable.
- Mangos ergonómicos y aislados en PVC.
- Juego de 2 pinzas (1 roja + 1 negra).



160x100 mm



Cód.	P.V.P. unid. €	
199370	40,75	1

PARA CABLE
25-35 mm²
Máx. Ø 11 mm

Se suministra en bolsa con colgador.



JUEGO DE 2 PINZAS DE BATERÍA DE BRONCE

- Cuerpo macizo de bronce.
- Con tornillo para sujeción de cable.
- Mangos ergonómicos y aislados en PVC.
- Juego de 2 pinzas (1 roja + 1 negra).



155x100 mm



Cód.	P.V.P. unid. €	
199368	34,39	1

PARA CABLE
25-35 mm²
Máx. Ø 11 mm

Se suministra en bolsa con colgador.



JUEGO DE 2 PINZAS DE BATERÍA DE ACERO

- Cuerpo en Acero recubierto de Zinc.
- Mangos ergonómicos y aislados en PVC.
- Juego de 2 pinzas (1 roja + 1 negra).



175x115 mm



Cód.	P.V.P. unid. €	
199369	3,37	12

PARA CABLE
25-35 mm²
Máx. Ø 11 mm

Se suministra en bolsa con colgador.



JUEGO DE 2 PINZAS DE BATERÍA DE ACERO

- Cuerpo en Acero recubierto de Zinc.
- Mangos ergonómicos y aislados en PVC.
- Juego de 2 pinzas (1 roja + 1 negra).



145x75 mm



Cód.	P.V.P. unid. €	
199367	2,48	12

PARA CABLE
25-35 mm²
Máx. Ø 11 mm

Se suministra en bolsa con colgador.



JUEGO DE 2 PINZAS DE BATERÍA DE ACERO

- Cuerpo en Acero recubierto de Zinc.
- Mangos ergonómicos y aislados en PVC.
- Juego de 2 pinzas (1 roja + 1 negra).



80x55 mm



Cód.	P.V.P. unid. €	
199365	1,53	12

PARA CABLE
25-35 mm²
Máx. Ø 11 mm

Se suministra en bolsa con colgador.

14

15

HERRAMIENTA VARIA



Cinta de amarre
con trinquete **345**

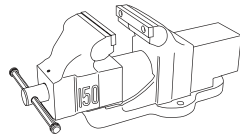

Tornillo de banco **349**

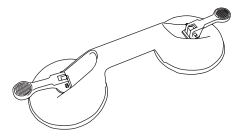

Ventosa **353**

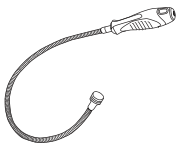

Dedo magnético **354**



Extractor **356**

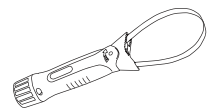

Llave para filtros **359**

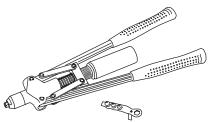

Remachadora **360**

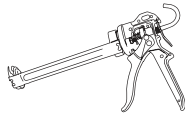

Aplicador sellante **364**



Aplicador
para mortero **365**

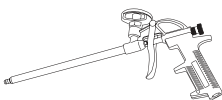

Aplicador poliuretano **365**



Bidón metálico **366**



Aceitera **366**

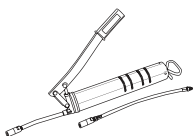

Bomba de engrase **367**

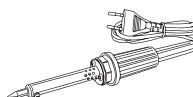

Soldador eléctrico **368**



Aplicador
termosellante **368**

SISTEMAS DE AMARRE

Nuestros sistemas de amarre o sujeción de mercancías están fabricados con los materiales más resistentes y cumpliendo con los estándares y normativas europeas establecidas para este tipo de productos, en los que la seguridad resulta esencial.

Normativa europea EN12195/2

Todos nuestros productos incluidos en las páginas 344 a 347 cumplen con los requisitos recogidos en la Normativa Europea EN12195/2. Esta normativa determina las características de todos y cada uno de los componentes de cualquier sistema de amarre, así como los modos de ensayo y de utilización.

Exigencias que deben cumplir los componentes de los sistemas de amarre:

- Partes metálicas: Los tensores de carraca, las hebillas y los ganchos deben tener una resistencia de rotura mínima del **DOBLE** de la capacidad de amarre del sistema, definida en tracción directa.
- Cintas de amarre: Las cintas, antes de la operación de cosido, deben tener una resistencia de rotura mínima del **TRIPLE** de la capacidad de amarre del sistema, definida en tracción directa.

Definición de carga (WLL): Define la tensión máxima de utilización o capacidad de amarre. Se define en tracción directa o en posición de amarre. Empleamos iconos explicativos del modo de uso en cada viñeta de esta familia.

La elongación del sistema de amarre **no debe ser nunca superior al 7%** cuando se aplique una carga igual a la capacidad de amarre del sistema.

Esta Normativa Europea no define un código de color para la identificación de la capacidad de carga.



Carga amarrado.



Carga directa.

Etiqueta del producto

Logo del distribuidor.	<p>NO APTA PARA ELEVACION DE CARGAS NÃO ADEQUADO PARA ELEVACÃO DE CARGAS NOT FOR LIFTING PAS POUR LE LEVAGE</p>
Advertencia de seguridad.	
WLL – Tensión máxima de utilización.	<p>Work Load Limit: 500 kgs</p>
Capacidad máxima de elongación de la cinta.	<p>Elongation: <7 % Polyester PES LGL: 3.0 m COD: 151010 DATE: EN 12195-2:2000 AFPS GS 2014:01</p>
Material de fabricación del producto.	
Longitud del sistema de amarre.	
Código del producto.	
Fecha de fabricación.	
Normativa Europea que cumple.	<p>Work Load Limit: 500 kgs</p>
Marca de cumplimiento de la ley de seguridad de productos alemana.	
WLL – Tensión máxima de utilización.	<p>Work Load Limit: 500 kgs</p>
Capacidad máxima de elongación de la cinta.	<p>Elongation: <7 % Polyester PES LGL: 3.0 m COD: 151010 DATE:</p>
Material de fabricación del producto.	
Longitud del sistema de amarre.	
Código del producto.	
Fecha de fabricación.	

Parte de la etiqueta no cosida a la cinta.

Parte de la etiqueta cosida a la cinta.

CINTA DE AMARRE 25MM CON TRINQUETE

- Cinta 100% poliéster de alta resistencia.
- Compuesto por cinta de 25 mm de ancho x 3 metros de largo y tensor de carraca.

EN12195/2



CARGA MÁXIMA ADMISIBLE



500 Kgs.

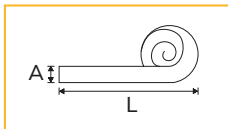

Cód.	A mm	L m	P.V.P. unid. €	
151010	25	3,0	3,47	1

CINTA DE AMARRE 25MM CON TRINQUETE

- Cinta 100% poliéster de alta resistencia.
- Compuesto por cinta de 25 mm de ancho x 5 metros de largo, tensor de carraca y 2 ganchos abiertos.
- Longitud tramo cinta con trinquete: 200 mm.

EN12195/2



CARGA MÁXIMA ADMISIBLE



700 Kgs.



350 Kgs.

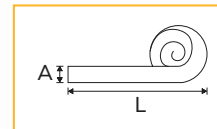

Cód.	A mm	L m	P.V.P. unid. €	
151012	25	5,0	5,10	1

**CINTA DE AMARRE
35MM CON TRINQUETE**

- Cinta 100% poliéster de alta resistencia.
- Compuesto por cinta de 35 mm de ancho x 6 metros de largo, tensor de carraca y 2 ganchos cerrados.
- Longitud tramo cinta con trinquete: 300 mm.

EN12195/2



CARGA MÁXIMA ADMISIBLE



Cód.	A mm	L m	P.V.P. unid. €	
151015	35	6,0	12,23	1

**CINTA DE AMARRE
35MM CON TRINQUETE**

- Cinta 100% poliéster de alta resistencia.
- Compuesto por cinta de 35 mm de ancho x 6 metros de largo, tensor de carraca y 2 ganchos abiertos.
- Longitud tramo cinta con trinquete: 300 mm.

EN12195/2



CARGA MÁXIMA ADMISIBLE

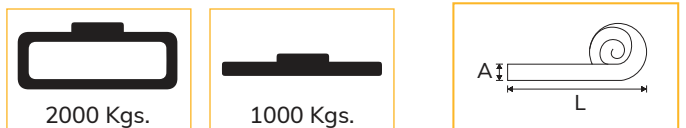

Cód.	A mm	L m	P.V.P. unid. €	
151017	35	6,0	12,23	1

**CINTA DE AMARRE
50MM CON TRINQUETE**

- Cinta 100% poliéster de alta resistencia.
- Compuesto por cinta de 50 mm de ancho x 3 longitudes diferentes (8,5 - 10,0 y 12,0 metros de largo), tensor de carraca y 2 ganchos cerrados.
- Longitud tramo cinta con trinquete: 500 mm.

EN12195/2



CARGA MÁXIMA ADMISIBLE



Cód.	A mm	L m	P.V.P. unid. €	
151020	50	8,5	19,98	1
151025	50	10,0	24,46	1
151030	50	12,0	26,10	1

**CINTA DE AMARRE
50MM CON TRINQUETE**

- Cinta 100% poliéster de alta resistencia.
- Compuesto por cinta de 50 mm de ancho x 3 longitudes diferentes (8,5 - 10,0 y 12,0 metros de largo), tensor de carraca y 2 ganchos abiertos.
- Longitud tramo cinta con trinquete: 500 mm.

EN12195/2



CARGA MÁXIMA ADMISIBLE

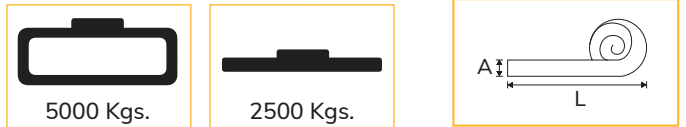

Cód.	A mm	L m	P.V.P. unid. €	
151022	50	8,5	19,98	1
151027	50	10,0	24,46	1
151032	50	12,0	26,10	1



CINCHA DE AMARRE 50MM PARA REMOLQUE

- Cinta 100% poliéster de alta resistencia.
- Compuesto por cinta de 50 mm de ancho x 4 metros de longitud con 2 ganchos planos.

EN1492/4



CARGA MÁXIMA ADMISIBLE

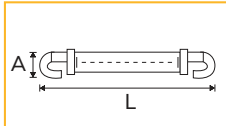
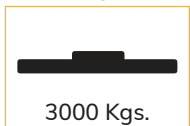

Cód.	A mm	L m	P.V.P. unid. €	
151036	50	4	9,38	1

Se suministra en bolsa individual



CINCHA DE AMARRE 50MM PORTACOCHE

- Cinta 100% poliéster de alta resistencia.
- Compuesto por cinta de 50 mm de ancho x 4 metros de longitud con 3 grandes abiertos.

EN12195/2

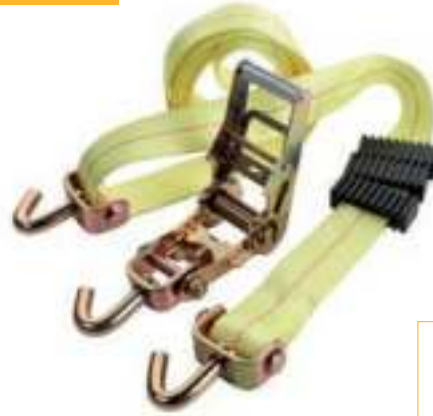
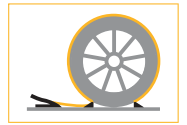

CARGA MÁXIMA ADMISIBLE

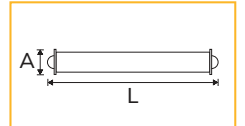
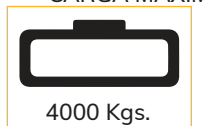

Cód.	A mm	L m	P.V.P. unid. €	
151038	50	4	28,95	1

Se suministra en bolsa individual



SET DE DOS CINTAS DE AMARRE 25MM CON HEBILLA

- Cinta 100% poliéster de alta resistencia.
- Compuesto por cinta de 25 mm de ancho x 3 metros de largo y una hebilla de amarre.

EN12195/2



CARGA MÁXIMA ADMISIBLE

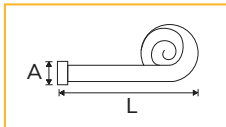
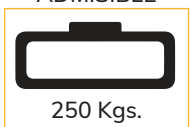

Cód.	A mm	L m	P.V.P. unid. €	
151040	25	3	3,67	1

Se suministra en blister de 2 unidades



CINTA DE AMARRE 35MM CON HEBILLA

- Cinta 100% poliéster de alta resistencia.
- Compuesto por cinta de 35 mm de ancho x 4 metros de largo y una hebilla de amarre.



CARGA MÁXIMA ADMISIBLE

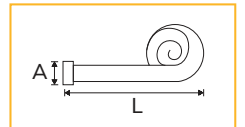

Cód.	A mm	L m	P.V.P. unid. €	
151042	35	4	5,50	1

Se suministra en blister

**CINTA DE AMARRE
25MM DE POLIÉSTER**

- Cinta 100% poliéster de alta resistencia.
- Rollo de cinta de 50 metros.



CARGA MÁXIMA
ADMISIBLE

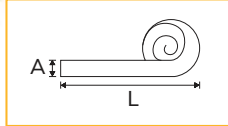

Cód.	A mm	L m	P.V.P. unid. €	
151050	25	50	11,82	1

**CINTA DE AMARRE
35MM DE POLIÉSTER**

- Cinta 100% poliéster de alta resistencia.
- Rollo de cinta de 50 metros.



CARGA MÁXIMA
ADMISIBLE

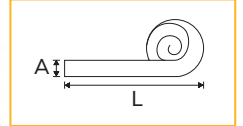
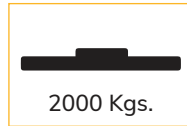

Cód.	A mm	L m	P.V.P. unid. €	
151052	35	50	27,12	1

**CINTA DE AMARRE
50MM DE POLIÉSTER**

- Cinta 100% poliéster de alta resistencia.
- Rollo de cinta de 50 metros.



CARGA MÁXIMA
ADMISIBLE

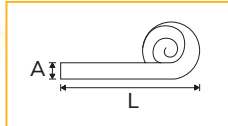
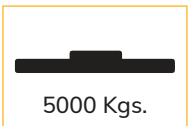

Cód.	A mm	L m	P.V.P. unid. €	
151054	50	50	50,15	1

**CARRACA INDIVIDUAL PARA
CINTA DE AMARRE DE 25MM**

- Carraca fabricada en aleación de acero con acabado anticorrosivo (zincado).
- Capacidad máxima: 800 kgs.



Para cinta 25 mm

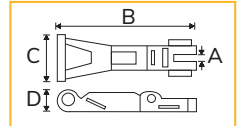

Cód.	A mm	B mm	C mm	D mm	P.V.P. unid. €	
151060	26	128	42	42	2,20	1

**CARRACA INDIVIDUAL PARA
CINTA DE AMARRE DE 35MM**

- Carraca fabricada en aleación de acero con acabado anticorrosivo (zincado).
- Capacidad máxima: 3000 kgs.



Para cinta 35 mm

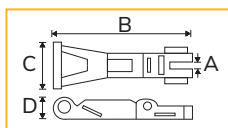

Cód.	A mm	B mm	C mm	D mm	P.V.P. unid. €	
151062	39	153	74	50	5,30	1

**CARRACA INDIVIDUAL PARA
CINTA DE AMARRE DE 50MM**

- Carraca fabricada en aleación de acero con acabado anticorrosivo (zincado).
- Capacidad máxima: 5000 kgs.



Para cinta 50 mm

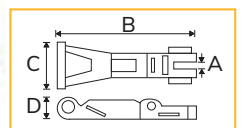

Cód.	A mm	B mm	C mm	D mm	P.V.P. unid. €	
151064	53	235	108	57	7,14	1



PACK DE PULPOS DE GOMA ELÁSTICA

- Pack compuesto por 2 gomas elásticas de \varnothing 9 mm x 800 mm de longitud con doble gancho.
- Presentación en color azul con puntos negros.



Cód.	Nº piezas	P.V.P. unid. €	
151070	2	2,36	6

Se suministra en bolsa de plástico.



PACK DE PULPOS DE GOMA ELÁSTICA

- Pack compuesto por 6 gomas elásticas con doble gancho, de: \varnothing 8 mm x 800 mm, en color rojo (2 unidades). \varnothing 8 mm x 1000 mm, en color azul (2 unidades). \varnothing 8 mm x 1500 mm, en color amarillo (2 unidades).



Cód.	Nº piezas	P.V.P. unid. €	
151072	6	5,10	1

Se suministra en bolsa de plástico.



PACK DE PULPOS DE GOMA ELÁSTICA

- Pack compuesto por 25 gomas elásticas con doble gancho, en colores amarillo, azul, verde, roja y negra de:
 - \varnothing 4 mm x 250 mm (6 unid.).
 - \varnothing 8 mm x 330 mm (5 unid.).
 - \varnothing 8 mm x 450 mm (5 unid.).
 - \varnothing 8 mm x 610 mm (5 unid.).
 - \varnothing 9 mm x 760 mm (2 unid.).
 - \varnothing 10 mm x 910 mm (2 unid.).



Cód.	Nº piezas	P.V.P. unid. €	
151074	25	13,86	1

Se suministra en bote de plástico.



PULPO DE GOMA ELÁSTICA DE 8 BRAZOS

- Pack compuesto por 4 gomas elásticas de color rojo, de \varnothing 8 mm x 800 mm de longitud, con doble gancho.

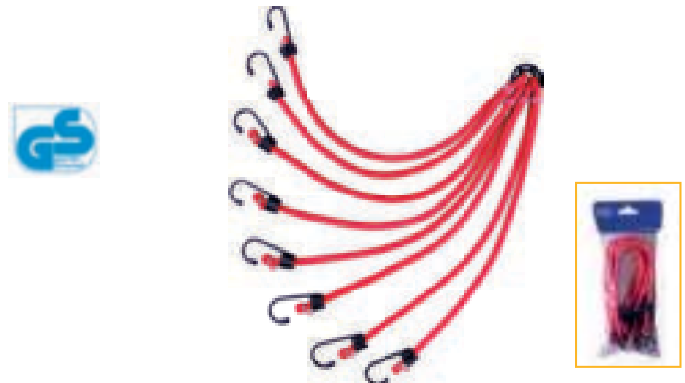

Cód.	Nº piezas	P.V.P. unid. €	
151078	4	3,22	6

Se suministra en bolsa de plástico.



RED DE AMARRE

- Red de \varnothing 4 mm en color negro, especial para sujeción de cargas, con dimensiones: 400x400 mm.
- Dispone de 6 ganchos metálicos.



Cód.	A x B mm	\varnothing mm	P.V.P. unid. €	
151080	400x400	4	2,69	3

Se suministra en bolsa de plástico.



RED DE AMARRE

- Red de \varnothing 4 mm en color negro, especial para sujeción de cargas, con dimensiones: 1800x1300 mm.
- Dispone de 12 ganchos de plástico.

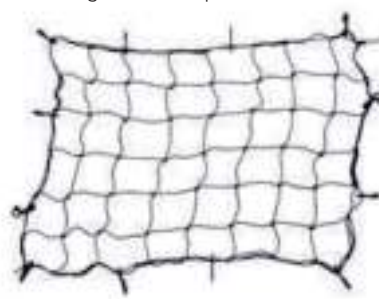

Cód.	A x B mm	\varnothing mm	P.V.P. unid. €	
151082	1800x1300	4	9,30	3

Se suministra en bolsa de plástico.



TORNILLO DE BANCO MULTIFUNCIÓN

- Fabricado en fundición nodular de alta calidad.
- Dispone de doble mordaza: parte superior, plana / parte inferior, para tubos.
- Bocas intercambiables.
- Con base giratoria a 360°.

Mordazas dentadas endurecidas. Proporcionan una fuerza de agarre óptima.

Mordazas con mandíbulas moleteadas para agarrar objetos firmemente.

Zona de golpeo endurecida en el yunque. Proporciona espacio adicional de trabajo.

Tornillo de bloqueo del giro de la cabeza.

360°

Posibilidad de girar la cabeza del tornillo de banco a 360°. 12 posiciones diferentes de bloqueo.



Proporciona una cantidad infinita de ajustes.

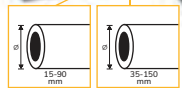

Mordazas extraíbles específicas para tubos.



Base giratoria a 360°.

CAPACIDAD APRIETE



Cód.	L mm	Peso Kgs	P.V.P. unid. €	
199362	150	25	575,00	1

Ver accesorios en página 351.

CARACTERÍSTICAS DEL TORNILLO

A mm	B mm	C mm	DxM mm	H mm
125	70	300	85x70	230



TORNILLO DE BANCO DE GUÍA REDONDA

- Bocas intercambiables.
- Bocas templadas para una mayor duración.
- Bocas moleteadas para mayor amarre.
- Posibilidad de acoplar bocas de goma magnéticas.

Dos puntos de engrase para un mantenimiento adecuado del mecanismo interior (2º punto en la parte posterior del husillo).

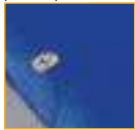

Yunque con amplia zona de golpeo.

Tornillo de banco fabricado en Acero de alta resistencia.

2º punto de engrase.

Topes laterales en la palanca de giro, para evitar su caída.



Ambas mordazas (fija y móvil) forjadas en una sola pieza.

Posibilidad de fijación sobre mesa de trabajo mediante tornillo.

Husillo interior recubierto en toda su longitud por guía cilíndrica.

15

Cód.	L mm	Peso Kgs	P.V.P. Unid. €	
199350	100	15	313,62	1
199355	125	23	422,23	1
199360	150	32	589,39	1

Ver accesorios en página 351.

CARACTERÍSTICAS DEL TORNILLO

Cód.	A mm	B mm	C mm	DxM mm	H mm	Apriete Kgs
199350	110	80	197	109x100	230	5000
199355	135	88	225	144x125	240	6500
199360	165	95	247	152x150	265	7500



TORNILLO DE BANCO GUÍA CUADRADA

- Fabricado en Acero.
- Mordaza fija y móvil forjadas en una sola pieza.
- Bocas:
 - Intercambiables.
 - Templadas para una mayor duración.
 - Moleteadas para un mejor amarre.
- Con base giratoria a 360°.
- Zona de golpeo en el yunque.
- Mordaza para tubos en la parte interior de las bocas.

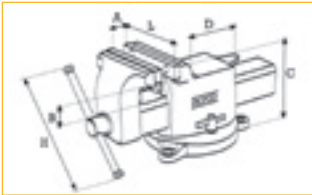

Cód.	L mm	Peso Kgs	P.V.P. Unid. €	
199300	75	6	122,01	1
199305	100	7,5	146,43	1
199310	125	11	174,86	1
199315	150	14,5	218,23	1

CARACTERÍSTICAS DEL TORNILLO						
Cód.	A mm	B mm	C mm	D mm	H mm	Apriete Kgs
199300	75	33	137	39	11	2500
199305	100	43	145	49	11	3500
199310	125	44	145	49	12	4000
199315	150	56	181	74	13	5000

Ver accesorios en página siguiente.



TORNILLO DE BANCO GUÍA CUADRADA

- Fabricado en fundición nodular.
- Bocas intercambiables.
- Con base giratoria a 360°.
- Zona de golpeo en el yunque.

CAPACIDAD APRIETE



171320



171330

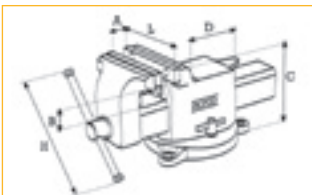

Cód.	L mm	Peso Kgs	P.V.P. Unid. €	
171320	100	7	108,00	1
171330	150	13	140,00	1

CARACTERÍSTICAS DEL TORNILLO						
Cód.	A mm	B mm	C mm	D mm	H mm	Apriete Kgs
171320	100	50	120	75	165	2000
171330	140	65	147	105	199	3000

Ver accesorios en página siguiente.



TORNILLO DE SOBREMESA

- Fabricado en hierro fundido.
- Mordazas:
 - Intercambiables.
 - Templadas para mayor duración.
 - Moleteadas para mayor amarre.
- Incluye base giratoria a 360°.
- Zona de golpeo en el yunque.
- Husillo para amarre sobre mesa de trabajo.



CAPACIDAD APRIETE

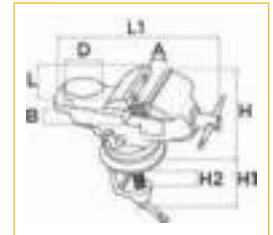

CARACTERÍSTICAS DEL TORNILLO						
A máx. mm	B mm	H mm	H1 mm	D mm	L1 mm	H2 mm
90	38	100	126	55	200	62

Cód.	L mm	Peso Kgs	P.V.P. Unid. €	
199325	65	4	79,18	1

Ver accesorios en parte inferior de esta pág.



MORDAZA MANUAL PARA TALADRO

- Fabricado en hierro fundido.
- Ranuras laterales con guías para fijarlo a la mesa.
- Utilización: taladros de mesa, mesas de trabajo.
- Mordazas intercambiables, templadas y moleteadas.



CAPACIDAD APRIETE

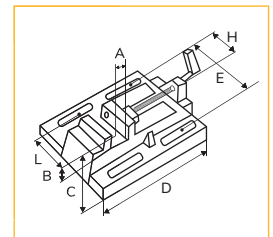

CARACTERÍSTICAS DEL TORNILLO					
A máx. mm	B mm	C mm	D mm	E mm	H mm
105	27	56	193	130	75

Cód.	L mm	P.V.P. unid. €	
199332	100	36,00	1

Ver accesorios en parte inferior de esta pág.



MORDAZAS METÁLICAS INTERCAMBIABLES

- Mordazas en Acero Cr-V. Templadas y moleteadas.
- Se suministran con tornillos para su colocación.



MORDAZAS DE GOMA INTERCAMBIABLES

- Banda magnética para acoplamiento en tornillo de banco.
- Mordazas fabricadas en goma.



Cód.	L mm	mm	Para Cód.	P.V.P. Unid. €	
199326	65	35	199325	12,12	1 par
199301	75	48	199300	21,96	1 par
171321	100	70	171320	14,80	1 par
199306	100	70	199305	27,60	1 par
199351	100	70	199350	30,46	1 par
199333	100	60	199332	20,00	1 par
199311	125	88	199310	31,62	1 par
199356	125	88	199355	39,74	1 par
171331	150	60	171330	21,20	1 par
199316	150	108	199315	33,05	1 par
199361	150	109	199360/199362	46,38	1 par
199364	∅15-90	-	199362	20,00	1 par
199363	∅35-150	35	199362	14,00	1 par

P.V.P. por pareja de mordazas.

Cód.	L mm	Para Cód.	P.V.P. Unid. €	
199303	75	199300	30,37	1 par
199308	100	171320 / 199305 199332 / 199350	36,96	1 par
199313	125	199310 / 199355	43,42	1 par
199318	150	171330 / 199315 199360 / 199362	45,93	1 par

P.V.P. por pareja de mordazas.



ALICATE SACABOCADOS DE ALTA POTENCIA

- Cuerpo pintado para evitar la oxidación.
- Muelle de apertura y palanca de cierre.
- Mangos ergonómicos con protector de plástico.
- Tambor giratorio con 6 diámetros de punzones.
- Articulación al perforar que reduce el esfuerzo.



6 DIÁMETROS DE BOCA:
2, 2'5, 3, 3'5, 4, 4'5 MM.

Empleo para perforación en cuero, textil y plástico

Cód.	L mm	P.V.P. unid. €	
111445	250	18,98	1

Se suministra en blíster.



ALICATE SACABOCADOS



- Cuerpo de acero.
- 6 puntas huecas perforadas en acero.
- 6 tamaños de punzón 2.5, 3.0, 3.5, 4.0, 4.5, 5.0 mm.



Cód.	L mm	P.V.P. unid. €	
170892	225	10,03	6

Se suministra en blíster.



JUEGO REMACHADORA DE OJETES



Incluye sacabocados de Ø 4 mm.



Incluye 100 ojetes de Ø 4 mm.

Cód.	L mm	P.V.P. unid. €	
170894	145	7,17	4

Se suministra en blíster.



TENSOR PARA ABRAZADERAS

INSTRUCCIONES DE USO



1. Colocar la abrazadera.



2. Atar la abrazadera.



3. Cortar la abrazadera.

- Presión del tensado de la abrazadera regulable.
- Tensa y corta abrazaderas entre 2'2 y 4'8 mm.



Cód.	Medida mm	P.V.P. unid. €	
108395	160x130	37,40	1

Se suministra en blíster.



SACAGRAPAS

ACERO CR-V



Empleo en automoción para la extracción de grapas

- Terminación pulido cromado.
- Mango bicomponente ergonómico.



Cód.	Ø mm	L mm	P.V.P. unid. €	
118015	8	190	6,29	6
118020	10	235	7,28	6

Se suministra en blíster.



JUEGO DE SACAGRAPAS



Empleo en automoción para la extracción de grapas



Cód.	Nº Piezas	P.V.P. unid. €	
118030	5	35,99	1

Se suministra en caja de cartón.



JUEGO DE PALANCAS DE NYLON



Empleo en extracción e instalación de molduras, salpicaderos y tapicerías de vehículos



Cód.	Nº Piezas	P.V.P. unid. €	
118035	5	28,52	1

Se suministra en blíster.



VENTOSA DE UN CUERPO

- **UTILIZACIÓN:** Cristal, plástico, metal, mármol, granito, superficies lisas.

CAPACIDAD SUCCIÓN

45kg.



Cód.	Ø mm	P.V.P. unid. €	
198005	100	20,99	2



VENTOSA DE DOBLE CUERPO

- **UTILIZACIÓN:** Cristal, plástico, metal, mármol, granito, superficies lisas.

CAPACIDAD SUCCIÓN

60kg.



Cód.	Ø mm	P.V.P. unid. €	
198010	2x100	52,28	1



MASA MAGNÉTICA



- Imán de ferrita.
- Mango giratorio 360° con muelle ajustable.
- Incluye tuercas de acero, arandelas y tornillos.



15

Cód.	Ø mm	Fuerza Kg	Amp.	P.V.P. unid. €	
198002	50	7	200	5,69	10
198004	86	30	500	13,03	10

Se suministra en blíster.



PINZA MAGNÉTICA FLEXIBLE CON LUZ

- 1 Botón para apertura de las garras.
- 2 Botón encendido/apagado luz LED.
- 3 Parte central del cuerpo flexible.
- 4 Cuerpo fabricado en Aluminio muy ligero.

Cód.	L mm	P.V.P. unid. €	
121550	600	13,78	6

Se suministra en blíster.

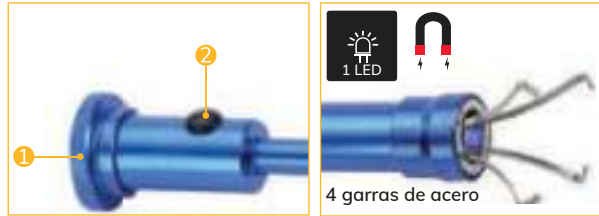

INCLUYE

 3 x LR44



ESPEJO TELESCÓPICO DE INSPECCIÓN CON LUZ



- 1 Espejo de 84x52 mm.
- 2 Junta universal para giro, inclinación y fijación.
- 3 Mango ergonómico antideslizante.

Cód.	L mm	P.V.P. unid. €	
121555	290/876	7,82	6

Se suministra en blíster.



INCLUYE

 2 x CR2032



DEDO MAGNÉTICO CON MANGO

Cód.	L mm	Ø Imán	Cap Kg	P.V.P. unid. €	
119135	510	10	1	22,44	1
119140	510	20	3	26,16	1



15 PASAHILOS EXTRAÍBLE DE NYLON

- Pasahilos de 4 mm de diámetro, en nylon.
- Hilo no conductor.

Cód.	L m	P.V.P. unid. €	
198915	15	21,51	1
198925	25	28,26	1



Para pasar todo tipo de cables

Punta recambiable



ÁNGULO MAGNÉTICO



- Cuerpo fabricado en Acero.
- Cuerpo unido por remaches.
- Parte interior con potente imán.
- Agujero para utilizar como elevador con grúa, excepto el cód. 197990.

UTILIZACIÓN:

- Soldaduras y montajes a diferentes ángulos (45°, 90°, 135°).
- Levantar cargas.
- Soporte de marcado, instalación de tubos, separado planchas.

Cód.	L mm	L1 mm	P.V.P. unid. €	
197990	85	120	5,33	10
197992	100	155	8,29	10
197995	120	185	12,92	10
197996	150	200	15,17	10



197990
197992
197995
197996

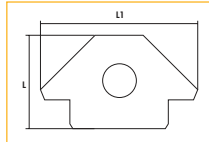

Soldadura 45°



Soldadura 90°



197990

Se suministra en blíster.



JUEGO DE 6 ÁNGULOS MAGNÉTICOS



- Ver características de los ángulos magnéticos en viñeta superior.

COMPOSICIÓN

- 2 unid. 85x120 mm (197990).
- 2 unid. 100x155 mm (197992).
- 2 unid. 120x185 mm (197995).

Cód.	P.V.P. unid. €	
197999	26,40	1

Se suministra en blíster.



ÁNGULO MAGNÉTICO CON REGULADOR DE POTENCIA DEL IMÁN



- Cuerpo fabricado en Acero.
- Cuerpo unido por remaches.
- Parte interior con potente imán.

Incluye selector para magnetizar-desmagnetizar. (Desde 0% hasta 100% de fuerza de imán).

Cód.	Fuerza kgs	P.V.P. unid. €	
197993	0-25	8,78	10
197997	0-50	12,15	10

Se suministra en blíster.

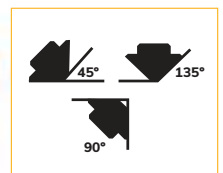

ÁNGULO MAGNÉTICO PARA INTERIORES



- Cuerpo fabricado en Acero.
- Cuerpo unido por remaches.
- Parte interior con potente imán.
- Agujero para utilizar como elevador con grúa.

Arrastre 13 Kg
Elevación 9 Kg

Cód.	P.V.P. unid. €	
197998	6,87	10

Se suministra en blíster.





EXTRACTOR REGULABLE DE 2 PATAS

ACERO CR-V

- Patas forjadas en una pieza para su utilización en trabajos de gran exigencia.

Cód.	H mm	L máx. mm	L mín mm	P.V.P. unid. €	
122300	100	85	15	70,32	1
122305	100	125	15	77,07	1
122310	150	160	20	132,64	1
122315	150	200	20	213,18	1

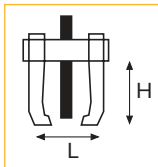

Para cambiar y extraer ruedas, engranajes, rodamientos a bolas, poleas, etc.



EXTRACTOR REVERSIBLE DE 2 PATAS

ACERO CR-V

- Extractor autocentrante.
- Terminación satinado mate.
- Husillo pavonado.

Cód.	Ø mm	P.V.P. unid. €	
122350	75	24,42	1
122355	150	45,51	1
122360	200	78,30	1



EXTRACTOR MÚLTIPLE DE 2 PATAS

ACERO CR-V

- Extremo de las patas en Acero Cr-V.
- Patas de recambio disponibles.
- Terminación satinado mate.
- Husillo pavonado.

COMPOSICIÓN

- Soporte forjado para patas de 175 mm.
- Husillo central M12 x 150 mm.
- 2 patas forjadas de 100 mm.
- 2 patas forjadas de 200 mm.
- 2 patas forjadas de 250 mm.

CAPACIDAD Ø MM

Utilización mín máx

Interna 80 180

Externa 25 130

3 LONGITUDES DE PATA: 100 / 200 / 250 MM.



Para utilizar como extractor interno y externo



15

Cód.	P.V.P. unid. €	
122365	146,18	1



PATAS DE RECAMBIO

ACERO CR-V

- Extremo de las patas en Acero Cr-V.
- Terminación satinado mate.
- Husillo pavonado.

Cód.	L mm	P.V.P. unid. €	
122210	100	14,61	1
122212	200	19,69	1
122214	250	24,61	1



Válido para 122365/122390/122395.



EXTRACTOR REVERSIBLE DE 3 PATAS



- Extractor autocentrante.
- Terminación satinado mate.
- Husillo pavonado.

Cód.	Ø mm	P.V.P. unid. €	
122375	75	33,00	1
122380	150	63,59	1
122385	200	117,42	1



EXTRACTOR MÚLTIPLE DE 3 PATAS



- Extremo de las patas en Acero Cr-V.
- Patas de recambio disponibles.
- Terminación satinado mate.
- Husillo pavonado.

3 LONGITUDES DE PATA:
100 / 200 / 250 MM.

Para utilizar como
extractor interno y externo

COMPOSICIÓN

- Soporte forjado para patas de 175 mm.
- Husillo central M12 x 150 mm.
- 3 patas forjadas de 100 mm.
- 3 patas forjadas de 200 mm.
- 3 patas forjadas de 250 mm.

CAPACIDAD Ø MM

Utilización	mín	máx
Interna	80	180
Externa	25	130

Cód.	P.V.P. unid. €	
122390	187,87	1



JUEGO DE EXTRACTOR DE 2 Y 3 PATAS



- Extremo de las patas en Acero Cr-V.
- Patas de recambio disponibles.
- Terminación satinado mate.
- Husillo pavonado.

3 LONGITUDES DE PATA:
100 / 200 / 250 MM.

6 EXTRACTORES EN 1

COMPOSICIÓN

- Soporte forjado para extractor 2 patas.
- Soporte forjado para extractor 3 patas.
- Husillo central M12 x 150 mm.
- 3 patas forjadas de 100 mm.
- 3 patas forjadas de 200 mm.
- 3 patas forjadas de 250 mm.

CAPACIDAD Ø MM

Utilización	mín	máx
Interna	80	180
Externa	25	130

Cód.	P.V.P. unid. €	
122395	228,81	1



15

Mismas características que 122365 y 122390.



JUEGO DE SEPARADORES DE GUILLOTINA

ACERO CR-V

■ Separadores en Acero Cr-V.

COMPOSICIÓN

1 Guillotina de 30 x 50 mm.
1 Guillotina de 50 x 75 mm.

Cód.	P.V.P. unid. €	
122200	120,03	1



Para la extracción de rodamientos, cajas de cambio, poleas y volantes



SEPARADOR DE GUILLOTINA

ACERO CR-V



Cód.	Ø mín mm	Ø máx mm	P.V.P. unid. €	
122204	75	105	49,48	1
122206	100	150	126,08	1



EXTRACTOR UNIVERSAL DE RÓTULAS

ACERO CR-V



Cód.	A mín/máx	B mín/máx	P.V.P. unid. €	
122220	12/50	18/22	15,53	1



EXTRACTOR DE RÓTULAS

ACERO CR-V



Cód.	A mín/máx	B mm	P.V.P. unid. €	
122225	12/50	20	28,67	1



EXTRACTOR DE RÓTULAS

ACERO CR-V



Cód.	A mín/máx	B mm	P.V.P. unid. €	
122230	60/80	20	37,11	1

15



JUEGO DE EXTRACTORES PARA TORNILLOS ROTOS

ACERO CR-V

■ Extractor de espárragos para tuercas, tornillos y pernos rotos.

COMPOSICIÓN

Nº	Ø mm	Ø "	Para métrica
1	1,4/3,6	1/8-1/4	M3-M6
2	2,1/4,9	1/4-5/16	M6-M8
3	3,1/6,5	5/16-7/16	M8-M11
4	4,8/8,8	7/16-9/16	M11-M14
5	6,2/11,0	9/16-3/4	M14-M18

Cód.	Nº Piezas	P.V.P. unid. €	
122330	5	13,37	1

Se suministra en blíster.





LLAVE DE FLEJE PARA FILTROS



Para extracción de filtros de aceite



Espesor 0,60 mm / Anchura 12 mm

Cód.	Ø Filtro mm	L mm	P.V.P. unid. €	
198852	65-110	240	26,66	6
198857	110-155	280	27,25	6

Se suministra en blíster.



REPUESTO DE FLEJE				
Cód.	Ø Filtro mm	P.V.P. unid. €		
198851	65-110	3,44	6	
198856	110-155	4,03	6	



LLAVE DE FLEJE PARA FILTROS



- Tornillo moleteado de Ø 40 mm.
- Cuerpo de aluminio.
- Terminación aluminio pintado rugoso.
- Fleje de acero de repuesto.



Para extracción de filtros de aceite



Espesor 0,60 mm / Anchura 12 mm

Cód.	Ø Filtro mm	L mm	P.V.P. unid. €	
198850	65-110	215	13,03	6
198855	110-155	260	15,40	6

Se suministra en blíster.



REPUESTO DE FLEJE				
Cód.	Ø Filtro mm	P.V.P. unid. €		
198851	65-110	3,44	6	
198856	110-155	4,03	6	



LLAVE PARA FILTROS DE 3 PATAS



- Incluye adaptador de 1/2" H x 3/8" M.

PARA FILTROS 63-120MM.
PARA ■ DE 3/8"-1/2".
PATA REDONDA Ø 10 MM.

Cód.	Medidas mm	P.V.P. unid. €	
122255	80x80x100	23,15	1

Se suministra en blíster.



Para extracción de filtros de aceite



LLAVE PARA FILTROS DE 3 PATAS



PARA FILTROS 63-102MM.
PATA PLANA 13 X 4 MM.

Cód.	Medidas mm	P.V.P. unid. €	
122250	80x80x47	13,40	1





REMACHADORA ALTA POTENCIA DE 2 MANOS

- Cuerpo fabricado en Aluminio.
- Mangos ergonómicos bimateriales.
- Incluye llave para cambiar las bocas.
- Incluye 4 bocas de diferentes tamaños.
- Con botella de plástico recogedora de remaches.

**30% MENOS ESFUERZO.
INCLUYE 4 BOCAS.**

COMPOSICIÓN

183105 PARA REMACHES

- Ø 2'4 mm - 3/32"
- Ø 3'2 mm - 1/8"
- Ø 4'0 mm - 5/32"
- Ø 4'8 mm - 3/16"

183115 PARA REMACHES

- Ø 3'2 mm - 1/8"
- Ø 4'0 mm - 5/32"
- Ø 4'8 mm - 3/16"
- Ø 6'4 mm - 1/4"



183105



183115



Utilizable con remaches inoxidables

Cód.	L mm	P.V.P. unid. €	
183105	300	45,11	1
183115	325	61,27	1



JUEGO DE REMACHADORA

- Cuerpo fabricado en aluminio.
- Palanca móvil forjada.
- Mango ergonómico.
- Cierre de seguridad.
- Bocas fabricadas en Acero.

**INCLUYE 4 BOCAS,
REMACHES Y ARANDELAS.**

COMPOSICIÓN

- 1 remachadora con cuatro bocas: 2,4 - 3,2 - 4,0 y 4,8 mm.
- 80 remaches: 20 de 2,4 mm; 20 de 3,2 mm; 20 de 4,0 mm y 20 de 4,8 mm.
- 20 arandelas: 5 de 2,4 mm; 5 de 3,2 mm; 5 de 4,0 mm y 5 de 4,8 mm.

Cód.	L mm	P.V.P. unid. €	
183100	250	39,55	1

Se suministra en caja de plástico.

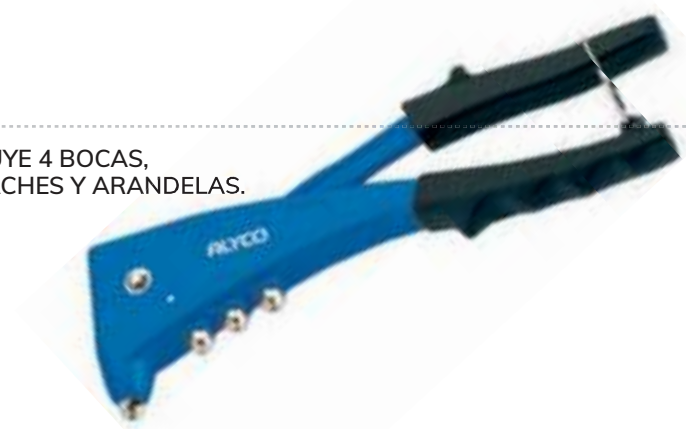

Utilizable con remaches inoxidables

Medida de caja:
325x155x55 mm.



REMACHADORA DE 2 MANOS

- Cuerpo fabricado en aluminio.
- Mangos tubulares fabricados en Acero.
- Mangos ergonómicos fabricados en goma blanda.
- Bocas fabricadas en Acero.
- Cierre de seguridad.
- Incluye llave para cambio de bocas.
- Bote de plástico para los remaches utilizados.

**INCLUYE 4 BOCAS
3,2-4,0-4,8-6,4 MM.**

Cód.	L mm	P.V.P. unid. €	
183110	450	75,25	1



Utilizable con remaches inoxidables



ACCESORIOS DE REMACHADORAS

Cód.	Descripción	Para Cód.	P.V.P. unid. €	
183107	JUEGO DE BOCAS	183105	10,14	1
183112	JUEGO DE BOCAS	183110	10,14	1
183117	JUEGO DE BOCAS	183115	10,14	1
183113	BOTE DE REMACHES	183110	4,96	1
183114	CABEZAL	183110	9,06	1



183107
183112
183117



183113



183114



REMACHADORA EXTENSIBLE

- Cuerpo fabricado en aluminio.
- Corredera con 4 remaches en Acero.
- Mango ergonómico de Aluminio.
- Bocas fabricadas en Acero.

INCLUYE 4 BOCAS
2,4-3,2-4,0-4,8 MM.

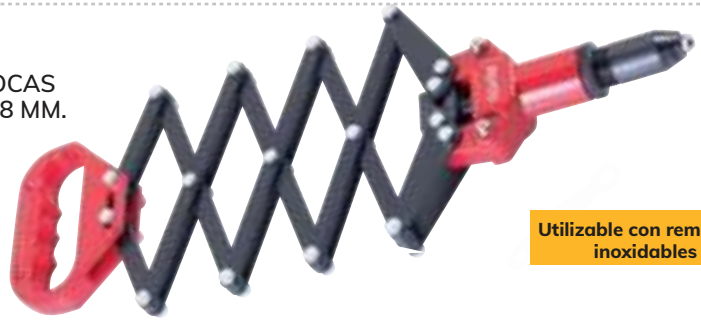

Utilizable con remaches
inoxidables

Cód.	L mm		P.V.P. unid. €	
	mín.	máx.		
183130	320	850	92,47	1



JUEGO DE REMACHADORA PARA TUERCAS

- Cuerpo fabricado en aluminio.
- Mangos ergonómicos recubiertos de PVC.
- Cierre de seguridad.

COMPOSICIÓN

- 1 remachadora para tuercas.
- 4 bocas para tuercas M3, M4, M5, M6.
- 40 tuercas: 10 - M3 / 10 - M4 / 10 - M5 / 10 - M6.

Cód.	L mm	P.V.P. unid. €	
183125	250	62,83	1



Medida caja:
325 x 155 x 55 mm.



Utilizable con remaches
inoxidables



REMACHADORA PARA TUERCAS DE 2 MANOS

- Cuerpo fabricado en aluminio.
- Mangos tubulares fabricados en Acero.
- Empuñaduras ergonómicas en goma blanda.

INCLUYE 4 BOCAS PARA
TUERCAS M5, M6, M8, M10.

Cód.	L mm	P.V.P. unid. €	
183120	450	99,95	1



Utilizable con remaches
inoxidables



BOCA DE RECAMBIO

PARA
183125



Cód.	Ø M	L mm	P.V.P. unid. €	
183126	M3	115	8,68	1
183127	M4	115	8,68	1
183128	M5	115	8,68	1
183129	M6	115	8,68	1



BOCA DE RECAMBIO

PARA
183120



Cód.	Ø M	L mm	P.V.P. unid. €	
183121	M5	70	8,84	1
183122	M6	70	8,84	1
183123	M8	70	8,84	1
183124	M10	70	8,84	1



JUEGO DE REMACHADORA

- Cuerpo de aluminio.
- Palanca móvil forjada.
- Bocas fabricadas en acero.

COMPOSICIÓN

- 40 remaches:
 - 10 de 2,4 mm · 10 de 3,2 mm
 - 10 de 4,0 mm · 10 de 4,8 mm
- Llave para cambio de bocas.
- Incluye 4 bocas 2,4 - 3,2 - 4,0 - 4,8 mm.



Cód.	L mm	Nº Piezas	P.V.P. unid. €	
170884	250	45	24,22	6

Se suministra en caja de plástico.



REMACHADORA DE DOS MANOS

- Cuerpo de aluminio.
- Mangos tubulares de acero.
- Bocas fabricadas en acero.
- Llave para cambio de bocas.
- Bote para remaches utilizados.

COMPOSICIÓN

- Incluye 4 bocas: 3,2 - 4,0 - 4,8 - 6,4 mm.

Cód.	L mm	P.V.P. unid. €	
170888	450	32,82	2



GRAPADORA 3 EN 1

GRAPADORA		
Cód.	P.V.P. unid. €	
171275	12,37	6

Incluye 600 grapas: 200 uds 171280 + 200 uds 171282 + 200 uds 171284.



GRAPAS DE RECAMBIO					
Cód.	Tipo	mm	Paquete de	P.V.P. unid. €	
171280		1.2x11.3x8	1000 u.	2,51	20
171282		1.2x6.3x12	1000 u.	2,62	20
171284		1.2x10	2000 u.	3,66	20



Precio por cada paquete.

15



GRAPADORA

GRAPADORA		
Cód.	P.V.P. unid. €	
171270	11,95	6

Incluye 600 grapas 171285.



GRAPAS DE RECAMBIO					
Cód.	Tipo	mm	Paquete de	P.V.P. unid. €	
171285		0.7x11,3x8	1000 u.	2,36	20

Precio por cada paquete.





ALICATE MULTIFUNCIÓN EN BOLSA DE NYLON

ACERO INOX

- Mangos fabricados en Aluminio anodizado.
- Se suministra con bolsa de nylon individual.



Alicate cerrado



Alicate abierto

Cód.	L abierto mm	P.V.P. unid. €	
101260	165	19,77	6

Se suministra en blíster y expositor.

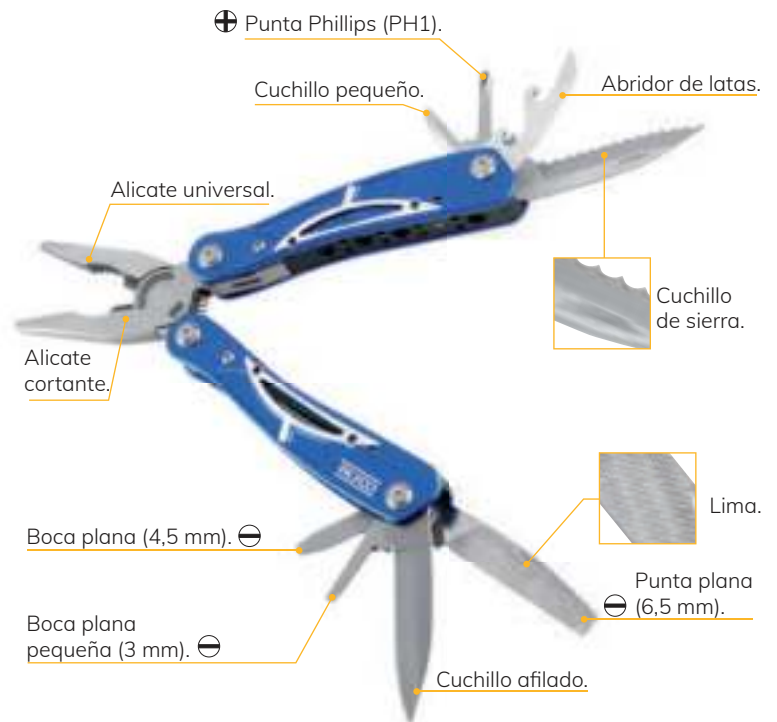

KIT DE ALICATE MULTIFUNCIÓN Y NAVAJA EN BOLSA DE NYLON

ACERO INOX

COMPOSICIÓN

- Alicate multifunción (cod. 101260).
- Navaja con mango de Aluminio.
- Bolsa de Nylon.



Cód.	Nº Piezas	P.V.P. unid. €	
101265	3	24,42	6

Se suministra en blíster y expositor.



CARACTERÍSTICAS NAVAJA:

- Hoja fabricada en Acero inoxidable.
- Hoja abatible sobre el mango.
- Mango de Aluminio anodizado.
- Con clip metálico en parte posterior.
- Con filo de corte liso.



MINI-ALICATE MULTIFUNCIÓN

ACERO INOX

FUNCIONES:

- Alicate universal.
- Alicate bocas planas.
- Boca plana 3 mm. ⊖
- Lima.
- Alicate cortacables.
- Cuchillo de sierra.
- Punta Phillips (PH1). ⊕
- Cuchillo pequeño.
- Abridor de latas con boca plana (3 mm). ⊖

Cód.	L mm		P.V.P. unid. €	
	abierto	cerrado		
101267	110	72	18,81	6

Se suministra en blíster y expositor.





APLICADOR SELLANTE DE ALTA POTENCIA

- Pistola de fricción de varilla cilíndrica.
- Tuerca de fricción de Acero.
- Mango reforzado en Aluminio de alta calidad.

RATIO FUERZA

18:1

ANTIGOTEO

Cód.	L mm	Ø mm	P.V.P. unid. €	
198807	225	50	20,59	6

PARA CARTUCHOS DE 310 ML.



Leva reforzada de 9 mm de espesor.

Empleo con productos de ALTA densidad



APLICADOR SELLANTE REFORZADO

- Pistola de fricción de varilla cilíndrica.
- Tuerca de fricción de Acero.
- Mango reforzado en Aluminio de alta calidad.

RATIO FUERZA

12:1

ANTIGOTEO

Cód.	L mm	Ø mm	P.V.P. unid. €	
198805	250	50	8,89	12

PARA CARTUCHOS DE 310 ML.

Empleo con productos de media densidad



APLICADOR SELLANTE

- Aplicador de fricción con varilla cilíndrica.
- Tuerca de fricción de acero.

Cód.	L mm	Ø mm	P.V.P. unid. €	
198802	325	50	4,95	24



15



APLICADOR SELLANTE DE FRICCIÓN

- Aplicador de fricción con varilla cilíndrica.

Cód.	L mm	Ø mm	P.V.P. unid. €	
198803	325	50	5,73	24





APLICADOR PARA MORTERO DE ALTA POTENCIA

RATIO FUERZA

24:1

ANTIGOTEO



198816
Boquillas
de recambio.



198816



Leva reforzada
de 9 mm de espesor.

Cuerpo tubular
de aluminio.

**PARA CARTUCHOS
DE 310, 400 Y 600 ML.**

Varilla perforada
de Ø 7,8 mm.

Tuerca de
aluminio.

Placa interior
metálica de 3,5 mm.

Mango de
aluminio reforzado.

Incluye boquilla de plástico
(recambios disponibles).

**Empleo con productos
de ALTA densidad**

Cód.	L mm	Ø mm	P.V.P. unid. €	
198818	380	50	26,59	2
BOQUILLAS DE RECAMBIO				
198816	Para 198818		1,24	12



APLICADOR PARA MORTERO

- Cuerpo tubular fabricado en Aluminio.
- Incluye boquilla de plástico (disponibles recambios).

RATIO FUERZA

12:1



198816
Boquillas
de recambio.



198816

Cód.	L mm	Ø mm	P.V.P. unid. €	
198810	250	50	12,28	2
198815	380	50	16,12	2
BOQUILLAS DE RECAMBIO				
198816	Para 198810 / 198815		1,24	12

**PARA CARTUCHOS
DE 310, 400 Y 600 ML.**



**Empleo con productos
de media densidad**

**PARA CARTUCHOS
DE 310 ML.**



APLICADOR PARA POLIURETANO

- Cuerpo del aplicador de zinc.
- Mango de plástico duro con forma ergonómica.
- Se suministra con 2 protectores para la punta.

Cód.	L mm	P.V.P. unid. €	
198820	350	25,41	2

**PUNTA DE ACERO
INOXIDABLE.**



**Para aplicación de
espuma de poliuretano**



APLICADOR PARA POLIURETANO TEFLONADO

- Cuerpo reforzado de aluminio.
- Varilla interior y válvula teflonadas.
- Tornillo de regulación de espuma ergonómico.
- Se suministra con 2 protectores para la punta.

Cód.	L mm	P.V.P. unid. €	
198821	350	33,51	2

**PUNTA DE ACERO INOXIDABLE.
VÁLVULA RECUBIERTA DE TEFLÓN.**



**Para aplicación de
espuma de poliuretano**



BIDÓN METÁLICO 10L

- Homologado Norma UN, para transporte de hidrocarburos.
- Fabricado en chapa de Acero de 0,8 mm.
- Cierre especial anti-fugas.
- Se suministra con boquilla flexible.

Cód.	L	Medidas mm	P.V.P. unid. €	
198870	10	275x125x380	35,55	1



BIDÓN METÁLICO 20L

- Homologado Norma UN, para transporte de hidrocarburos.
- Fabricado en chapa de Acero de 0,8 mm.
- Cierre especial anti-fugas.
- Se suministra con boquilla flexible.

Cód.	L	Medidas mm	P.V.P. unid. €	
198875	20	360x170x470	41,75	1



BOQUILLA FLEXIBLE

- Boquilla válida para bidones, cód. 198870 y 198875.

ACCESORIOS				
Cód.	Descripción	P.V.P. unid. €		
198876	Boquilla flexible	9,10	1	



ACEITERA METÁLICA

- Fabricada en chapa de Acero de 0,8 mm.
- Se suministra con 2 racores:
 - 1 racor flexible de 120 mm / 5".
 - 1 racor rígido de 120 mm / 5".

Cód.	Capacidad cc	Ø mm	P.V.P. unid. €	
198880	300	70	6,59	1



15



ACEITERA METÁLICA

- Fabricada en chapa de Acero de 0,8 mm.
- Se suministra con 2 racores:
 - 1 racor flexible de 120 mm / 5".
 - 1 racor rígido de 120 mm / 5".

Cód.	Capacidad cc	Ø mm	P.V.P. unid. €	
198882	500	80	7,35	1





BOMBA DE ENGRASE A PALANCA

- Cuerpo cromado.
- Palanca con empuñadura ergonómica.
- Con tornillo para purgado.

COMPOSICIÓN

- 1 Racor rígido de 150 mm / 6".
- 1 Racor flexible de 300 mm / 12" (198861).
- 2 Boquillas hidráulicas (198863).

Cód.	L mm	P.V.P. unid. €	
198860	400	22,08	1

En caja de cartón individual.

PRESIÓN MÁXIMA



500 BAR

CAPACIDAD

**CARTUCHO
400 cc**

**GRANEL
500 cc**



ACCESORIOS

Cód.	L mm	P.V.P. unid. €	
198861	300	4,34	1
198863	38	1,98	1



198861
Racor flexible + boquilla.

198863
Boquilla hidráulica.



INYECTOR DE ACEITE

- Incluye manguera flexible de 300 mm.

UTILIZACIÓN:

Para transmisiones, diferenciales, cajas de cambio, cárteres...

Cód.	L mm	P.V.P. unid. €	
198865	400	15,43	1

En caja de cartón individual.



Para vaciar y rellenar cualquier líquido no corrosivo



BOMBA MANUAL DE TRASVASE

- Conexión a bidón M2" G.
- Fabricada en Acero y Aluminio.

**PARA BIDONES 60-200 L.
ENTREGA 14 L/MIN.**

EXTENSIBLE

457 mm
890 mm

Cód.	L mm	P.V.P. unid. €	
198885	457/890	40,61	1

En caja de cartón individual.



Para trasvasar todo tipo de líquidos no corrosivos



15



SOLDADOR ELÉCTRICO

- Punta del soldador niquelada para mayor eficiencia.



AC 240 V.

Cód.	Potencia W	Ø punta mm	P.V.P. unid. €	
190580	30	4	15,34	1
190590	60	6	17,70	1
190596	80	8	23,82	1
PUNTAS DE RECAMBIO				
190581	para Cód. 190580		2,98	1
190591	para Cód. 190590		2,56	1
190597	para Cód. 190596		3,05	1



PUNTAS



Puntas de recambio.

Empleo en trabajos de electrónica

Se suministra en blíster.



BOMBA DESOLDADORA

INSTRUCCIONES DE USO:

Succión del estaño líquido presionando con el dedo.

Cód.	Medidas mm	P.V.P. unid. €	
190595	200x20	8,53	1

Se suministra en blíster.



PISTOLA TERMOSELLANTE

- Gatillo dispensador con control de flujo.
- Boquilla antigoteo.



INSTRUCCIONES DE USO:

- Introducir una barra de cola en el alojamiento de entrada.
- Precalentar entre 3-5 minutos.
- Presionar el gatillo y aplicar la cola.



UTILIZACIÓN:

- Madera.
- Plástico.
- Metal ligero.
- Cartón.
- Cerámica.
- Tela.

Cód.	P.V.P. unid. €	
198892	11,02	6

15

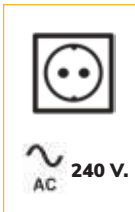

Incluye pie metálico.

Incluye 2 barras de cola de 11,2x200mm.



BARRAS DE COLA

- En bolsa de plástico con colgador.
- Cada bolsa incluye 10 barras de cola.

COLOR TRANSLÚCIDO.

Cód.	Nº Piezas	P.V.P. unid. €	
198895	10	5,92	20

Medidas: 11,2x200mm.
Peso: 20 gr.



16

HERRAMIENTA ANTICHISPA

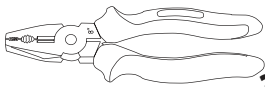

Alicatae Al-Br / Cu-Be **371**

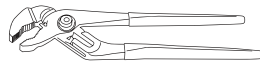

Tenaza Al-Br / Cu-Be **372**

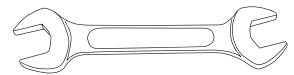

Llave fija Al-Br / Cu-Be **373**

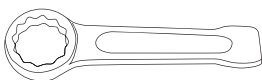

Llave de golpe Al-Br / Cu-Be **377**



Llave dinamométrica Al-Br / Cu-Be **378**

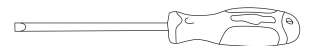

Destornillador Al-Br / Cu-Be **379**



Juego vasos Al-Br / Cu-Be **383**

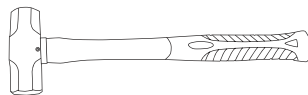

Maceta Al-Br / Cu-Be **384**

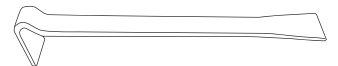

Rasqueta Al-Br / Cu-Be **385**



Cortafíos Al-Br / Cu-Be **386**



Cuña Al-Br / Cu-Be **386**



Cepillo de taza Lt / Cu **387**

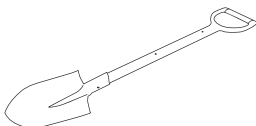

Pala Al-Br / Cu-Be **388**

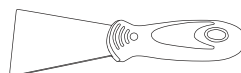

Espátula Al-Br / Cu-Be **389**

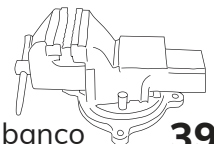

Tornillo de banco Al-Br / Cu-Be **390**

HERRAMIENTAS ANTICHISPA



Nuestra gama de herramientas antichispa ha sido concebida para su uso en entornos potencialmente explosivos, en los cuales el uso de las herramientas de acero no son recomendables por su tendencia a generar chispas que pueden provocar incendios o incluso explosiones.

Las herramientas fabricadas con materiales no ferrosos reducen el riesgo de chispas inflamables, además de tener una serie de características especiales de seguridad antimagnética y resistencia a la corrosión.

Zonas de utilización de herramientas antichispa (zonas ATEX)

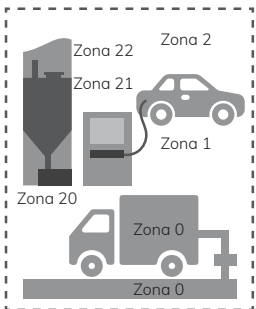

Zonas EX.

La directiva 1999/92/CE define las zonas y la seguridad de las personas trabajando en las zonas con peligro de explosión. La presencia de gases, líquidos o polvo, sobre todo en industrias petroquímicas, minas o industrias similares producen esos ambientes potencialmente explosivos.

Gases Vapores	Zona 0	Atmósfera con mezcla de aire y sustancias inflamables de manera frecuente.		Cu-Be
	Zona 1	Atmósfera con mezcla de aire y sustancias inflamables de manera ocasional.	Al-Br	Cu-Be
	Zona 2	Atmósfera con mezcla de aire y sustancias inflamables posible, pero en cortos periodos.	Al-Br	Cu-Be
Polvo	Zona 20	Atmósfera con nube de polvo combustible de manera frecuente, continua o durante largos periodos.		Cu-Be
	Zona 21	Atmósfera con nube de polvo combustible de manera ocasional.	Al-Br	Cu-Be
	Zona 22	Atmósfera con nube de polvo combustible, pero en cortos periodos.	Al-Br	Cu-Be

Características de las aleaciones aluminio-bronce (Al-Br) y cobre-berilio (Cu-Be)

AL-BR	Aluminio-Bronce (Al-Br)	CU-BE	Cobre-Berilio (Cu-Be)
<ul style="list-style-type: none"> Composición: <ul style="list-style-type: none"> -Aluminio: 10-12%. -Niquel: 3-6%. -Hierro + Manganeso: 5,8%. -Cobre + Aluminio + Niquel + Hierro + Manganeso: 99,9%. Dureza aprox: 20-30 HRC. Resistencia a la tracción: 782N/mm² – 989N/mm². Límite elástico: 450N/mm² – 550N/mm². Extensibilidad: >=5,0%. Herramienta micromagnética: 1,2%. Apropiada para operar en ambientes con concentración de etileno por debajo de 7,8%. GB Ex IIB. 		<ul style="list-style-type: none"> Composición: <ul style="list-style-type: none"> -Berilio: 1,8%-2,3%. -Cobalto + Niquel: 0,2%. -Cobalto + Niquel + Hierro: 1,2%. -Cobre + Berilio + Cobalto + Niquel + Hierro: 99,9%. Dureza aprox: 30-40 HRC. Resistencia a la tracción: 1117N/mm² – 1326N/mm². Límite elástico: 840N/mm² – 880N/mm². Extensibilidad: <=1,0%. Herramienta no magnética: 0,0%. Apropiada para operar en ambientes con concentración de hidrógeno por debajo de 21,0%. GB Ex IIC. 	

Principales campos de aplicación

- Industria petroquímica. Refinerías. Tuberías de gas y aceite. Industria del automóvil.
- Centrales eléctricas. Fabricación de pintura. Fabricación de plástico. Industria aeroespacial.
- Industria farmacéutica. Industria química. Fabricación de fuegos artificiales. Armada.
- Minas. Fuerzas Aéreas. Bombas. Destilerías.

Instrucciones de uso

Al carecer de la dureza de las herramientas convencionales, deben ser utilizadas con especial cuidado, sobre todo en uso y temperatura de exposición. Solo serán sustituidas en caso de que no superen la dureza mínima (Al-Br 30HRC, Cu-Be 40HRC). No usar herramientas con más de 65% de contenido en cobre en contacto con acetileno, por su capacidad explosiva.



Garantía

Nuestras herramientas antichispa:

- Están fabricadas siguiendo las normas internacionales de seguridad en procesos certificados por los institutos BAM y FM.
- Cumplen todas las normas internacionales de dimensiones, capacidad de corte y dureza.

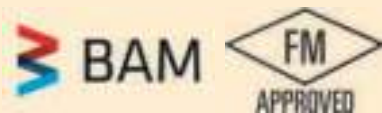



ALICATE UNIVERSAL AJUSTABLE



L mm	L"	AL-BR		CU-BE	
		Cód.	P.V.P. unid. €	Cód.	P.V.P. unid. €
150	6	127020	109,72	128020	180,43
200	8	127021	130,72	128021	214,64



ALICATE UNIVERSAL



L mm	L"	AL-BR		CU-BE	
		Cód.	P.V.P. unid. €	Cód.	P.V.P. unid. €
150	6	127008	108,62	128008	166,78
175	7	127010	119,78	128009	186,90
200	8	127012	139,36	128010	199,60
250	10	127013	184,10	128012	231,45



ALICATE DE CORTE DIAGONAL



L mm	L"	AL-BR		CU-BE	
		Cód.	P.V.P. unid. €	Cód.	P.V.P. unid. €
150	6	127018	116,33	128018	187,73
200	8	127019	124,39	128019	203,86



ALICATE DE BOCAS SEMIREDONDAS CON CORTE



L mm	L"	AL-BR		CU-BE	
		Cód.	P.V.P. unid. €	Cód.	P.V.P. unid. €
150	6	127015	115,17	128015	183,13
200	8	127016	129,00	128016	206,16



ALICATE DE BOCAS SEMIREDONDAS CURVO



L mm	L"	AL-BR		CU-BE	
		Cód.	P.V.P. unid. €	Cód.	P.V.P. unid. €
150	6	127024	134,76	128024	214,64



ALICATE DE BOCAS PLANAS



L mm	L"	AL-BR		CU-BE	
		Cód.	P.V.P. unid. €	Cód.	P.V.P. unid. €
150	6	127026	119,31	128026	196,25
200	8	127027	142,14	128027	238,94



Al-Br



Cu-Be

ALICATE DE PUNTAS REDONDAS



L mm	L"	AL-BR		CU-BE	
		Cód.	P.V.P. unid. €	Cód.	P.V.P. unid. €
150	6	127035	130,72	128035	210,60



Al-Br



Cu-Be

TENAZA PICO DE LORO



L mm	L"	AL-BR		CU-BE	
		Cód.	P.V.P. unid. €	Cód.	P.V.P. unid. €
150	6	127029	120,34	128029	160,90
250	10	127030	190,45	128030	266,05
300	12	127031	229,20	128031	343,22
350	14	127032	264,38	128032	428,22



Al-Br



Cu-Be

TENAZA CRIMPADORA PARA TERMINALES AISLADOS



L mm	L"	AL-BR		CU-BE	
		Cód.	P.V.P. unid. €	Cód.	P.V.P. unid. €
200	8	127040	168,64	128040	266,22



Al-Br



Cu-Be

TENAZA DE ARRANCAR



L mm	L"	AL-BR		CU-BE	
		Cód.	P.V.P. unid. €	Cód.	P.V.P. unid. €
200	8	127042	127,75	128042	207,30



Al-Br



Cu-Be

ALICATE PARA ARANDELAS SEEGER



INTERIORES
BOCA RECTA



Al-Br



Cu-Be

ALICATE PARA ARANDELAS SEEGER



EXTERIORES
BOCA RECTA

L mm	L"	AL-BR		CU-BE	
		Cód.	P.V.P. unid. €	Cód.	P.V.P. unid. €
200	8	127044	128,48	128044	206,93
250	10	127045	180,80	128045	292,72

L mm	L"	AL-BR		CU-BE	
		Cód.	P.V.P. unid. €	Cód.	P.V.P. unid. €
200	8	127047	128,48	128047	206,93
250	10	127048	180,80	128048	292,72



TENAZA GRIP
BOCAS CURVAS CON CORTE

Al-Br Cu-Be



AM
40 MM



L mm	L"	AL-BR		CU-BE	
		Cód.	P.V.P. unid. €	Cód.	P.V.P. unid. €
225	9	127050	228,66	128050	328,81



PINZAS DE PRECISIÓN

Al-Br Cu-Be



L mm	L"	AL-BR		CU-BE	
		Cód.	P.V.P. unid. €	Cód.	P.V.P. unid. €
150	6	127052	54,84	128052	86,89
200	8	127053	86,16	128053	133,29



TIJERA CORTACHAPAS

Al-Br Cu-Be

FILO DE
75 MM



L mm	L"	AL-BR		CU-BE	
		Cód.	P.V.P. unid. €	Cód.	P.V.P. unid. €
300	12	127055	176,72	128055	274,66



CORTABULONES

Al-Br Cu-Be



L mm	L"	AL-BR		CU-BE	
		Cód.	P.V.P. unid. €	Cód.	P.V.P. unid. €
600	24	127057	756,66	128057	1.223,53
900	36	127058	1.966,52	128058	3.278,04



LLAVE FIJA DE 2 BOCAS

Al-Br Cu-Be



mm	AL-BR		CU-BE	
	Cód.	P.V.P. unid. €	Cód.	P.V.P. unid. €
6x7	127100	20,73	128100	31,10
8x9	127101	21,88	128101	32,25
10x11	127102	25,34	128102	39,74
12x13	127103	33,40	128103	50,68
14x15	127104	43,77	128104	66,56
16x17	127105	51,83	128105	74,86
18x19	127106	54,13	128106	89,47
20x22	127107	76,02	128107	116,33
21x23	127108	81,77	128108	123,24
22x24	127115	90,56	128115	148,75
24x26	127116	111,93	128116	183,73
24x27	127109	124,39	128109	185,43
25x28	127110	134,75	128110	198,10

mm	AL-BR		CU-BE	
	Cód.	P.V.P. unid. €	Cód.	P.V.P. unid. €
27x29	127111	143,97	128111	221,45
30x32	127112	160,09	128112	256,76
32x34	127117	191,48	128117	312,58
34x36	127113	196,22	128113	326,25
36x41	127118	237,84	128118	388,46
41x46	127114	238,41	128114	436,51
46x50	127119	340,22	128119	556,33
50x55	127120	365,99	128120	597,23
55x60	127121	461,00	128121	752,95
60x65	127122	510,34	128122	833,97
65x70	127123	567,01	128123	922,69
70x80	127124	703,61	128124	1.150,25
75x85	127125	893,25	128125	1.456,96



JUEGO DE LLAVES FIJAS

Al-Br Cu-Be

COMPOSICIÓN

8x10, 10x12, 12x14,
14x17, 17x19, 19x22,
22x24, 24x27,
30x32 mm.



Nº Piezas	AL-BR		CU-BE	
	Cód.	P.V.P. unid. €	Cód.	P.V.P. unid. €
9	127126	651,34	128126	1.047,14



JUEGO DE LLAVES FIJAS

Al-Br Cu-Be

COMPOSICIÓN

6x7, 8x9, 10x11, 12x13,
14x15, 16x17, 18x19,
20x22, 21x23, 24x26,
25x28, 30x32 mm.



Nº Piezas	AL-BR		CU-BE	
	Cód.	P.V.P. unid. €	Cód.	P.V.P. unid. €
12	127127	832,50	128127	1.343,53



LLAVE COMBINADA

Al-Br Cu-Be



mm	AL-BR		CU-BE	
	Cód.	P.V.P. unid. €	Cód.	P.V.P. unid. €
6	127128	26,78	128128	49,70
7	127129	31,25	128129	54,11
8	127130	32,25	128130	56,44
9	127131	35,13	128131	63,35
10	127132	39,74	128132	70,26
11	127133	45,49	128133	73,71
12	127134	46,65	128134	81,77
13	127135	48,37	128135	87,53
14	127136	50,68	128136	90,99
15	127137	54,13	128137	92,14
16	127138	57,01	128138	100,20
17	127139	58,16	128139	110,57
18	127140	61,04	128140	114,02
19	127141	62,19	128141	116,33
20	127142	67,95	128142	125,54
21	127143	76,02	128143	139,36
22	127144	81,20	128144	147,42
23	127145	88,68	128145	154,33

mm	AL-BR		CU-BE	
	Cód.	P.V.P. unid. €	Cód.	P.V.P. unid. €
24	127146	95,60	128146	168,16
25	127147	109,42	128147	185,43
26	127148	123,81	128148	196,95
27	127149	135,91	128149	206,16
28	127150	146,27	128150	217,68
29	127151	155,49	128151	218,83
30	127152	162,40	128152	248,78
31	127153	171,61	128153	263,75
32	127154	176,22	128154	286,79
34	127155	236,74	128155	375,94
35	127156	253,70	128156	407,58
36	127157	278,00	128157	444,40
38	127158	300,06	128158	479,02
41	127159	352,01	128159	564,44
46	127165	411,66	128165	659,82
50	127166	439,27	128166	705,85
55	127167	483,06	128167	773,58
60	127168	520,61	128168	834,33



JUEGO DE LLAVES COMBINADAS

Al-Br Cu-Be

COMPOSICIÓN

8, 10, 12, 14, 17, 19,
22, 24, 27 mm.



Nº Piezas	AL-BR		CU-BE	
	Cód.	P.V.P. unid. €	Cód.	P.V.P. unid. €
9	127175	678,21	128175	1.092,80



JUEGO DE LLAVES COMBINADAS

Al-Br Cu-Be

COMPOSICIÓN

6, 8, 10, 12, 14, 17,
19, 22, 24, 27, 30,
32 mm.



Nº Piezas	AL-BR		CU-BE	
	Cód.	P.V.P. unid. €	Cód.	P.V.P. unid. €
12	127176	1.075,51	128176	1.741,57



LLAVE DE ESTRELLA ACODADA



mm	AL-BR		CU-BE	
	Cód.	P.V.P. unid. €	Cód.	P.V.P. unid. €
6x7	127180	21,31	128180	44,92
8x9	127181	23,03	128181	49,53
10x11	127182	25,34	128182	61,04
12x13	127183	31,10	128183	72,56
14x15	127184	38,01	128184	85,23
16x17	127185	49,53	128185	95,60
18x19	127186	54,13	128186	104,81
20x22	127187	65,65	128187	132,45
21x23	127188	71,41	128188	140,51
22x24	127192	90,56	128192	160,96
24x26	127193	111,93	128193	183,73
24x27	127194	119,31	128194	195,15

mm	AL-BR		CU-BE	
	Cód.	P.V.P. unid. €	Cód.	P.V.P. unid. €
25x28	127189	120,57	128189	214,65
27x29	127190	139,36	128190	229,20
30x32	127191	154,33	128191	263,75
32x34	127195	214,27	128195	349,81
34x36	127196	245,22	128196	401,35
36x41	127197	335,78	128197	547,16
41x46	127198	419,00	128198	683,02
46x50	127220	472,01	128220	771,38
50x55	127221	525,42	128221	860,10
55x60	127222	625,20	128222	1.022,47
60x70	127223	673,07	128223	1.099,82



JUEGO DE LLAVES ACODADAS



JUEGO DE LLAVES ACODADAS

COMPOSICIÓN

8x10, 10x12, 12x14, 14x17, 17x19, 19x22, 22x24, 24x27, 30x32 mm.

COMPOSICIÓN

6x7, 8x9, 10x11, 12x13, 14x15, 16x17, 18x19, 20x22, 21x23, 24x26, 25x28, 30x32 mm.



Nº Piezas	AL-BR		CU-BE	
	Cód.	P.V.P. unid. €	Cód.	P.V.P. unid. €
9	127225	661,65	128225	1.068,87

Nº Piezas	AL-BR		CU-BE	
	Cód.	P.V.P. unid. €	Cód.	P.V.P. unid. €
12	127226	841,35	128226	1.360,12



LLAVE DE ESTRELLA PLANA



mm	AL-BR		CU-BE	
	Cód.	P.V.P. unid. €	Cód.	P.V.P. unid. €
7x9	127605	22,83	128605	35,72
8x10	127606	24,67	128606	39,39
10x11	127607	26,14	128607	44,93
12x14	127608	36,82	128608	60,02
17x19	127609	51,91	128609	83,22
16x18	127610	58,92	128610	95,37

mm	AL-BR		CU-BE	
	Cód.	P.V.P. unid. €	Cód.	P.V.P. unid. €
20x22	127611	81,39	128611	134,76
21x23	127612	89,09	128612	145,08
24x27	127613	113,39	128613	187,40
25x28	127614	127,01	128614	207,30
30x32	127615	176,35	128615	287,91



LLAVE DE TUBO HEXAGONAL

Al-Br Cu-Be



mm	AL-BR		CU-BE	
	Cód.	P.V.P. unid. €	Cód.	P.V.P. unid. €
6x7	127620	60,39	128620	91,66
8x9	127621	74,01	128621	110,09
10x11	127622	86,89	128622	133,29
12x13	127623	111,93	128623	168,28
14x15	127624	142,14	128624	214,64
16x17	127625	199,18	128625	300,06

mm	AL-BR		CU-BE	
	Cód.	P.V.P. unid. €	Cód.	P.V.P. unid. €
18x19	127626	254,07	128626	385,12
20x22	127627	316,66	128627	477,55
21x23	127628	381,08	128628	578,06
24x27	127629	458,39	128629	694,07
25x28	127630	533,90	128630	810,03
27x30	127631	616,35	128631	931,17



LLAVE DE PIPA

Al-Br Cu-Be



mm	AL-BR		CU-BE	
	Cód.	P.V.P. unid. €	Cód.	P.V.P. unid. €
6	127635	108,26	128635	153,92
7	127636	108,62	128636	156,49
8	127637	109,72	128637	157,23
9	127638	111,93	128638	160,53
10	127639	113,03	128639	164,20
11	127640	115,96	128640	168,28
12	127641	120,41	128641	172,31
13	127642	130,72	128642	187,40
14	127643	135,13	128643	199,18
15	127644	146,18	128644	214,64

mm	AL-BR		CU-BE	
	Cód.	P.V.P. unid. €	Cód.	P.V.P. unid. €
16	127645	153,92	128645	223,12
17	127646	164,93	128646	238,21
18	127647	191,85	128647	280,20
19	127648	226,42	128648	330,64
21	127649	254,07	128649	369,30
22	127650	288,28	128650	419,37
24	127651	377,41	128651	543,81
27	127652	415,33	128652	598,33
30	127653	522,85	128653	756,29
32	127654	567,01	128654	821,45



LLAVE FIJA DE GOLPE

Al-Br Cu-Be



mm	AL-BR		CU-BE	
	Cód.	P.V.P. unid. €	Cód.	P.V.P. unid. €
17	127200	49,53	128200	90,99
19	127201	52,98	128201	96,75
22	127202	56,44	128202	101,35
24	127203	62,19	128203	114,02
27	127204	76,02	128204	137,06
30	127205	90,99	128205	160,09
32	127206	108,26	128206	181,98
36	127207	125,54	128207	225,74
38	127217	149,85	128217	245,59
41	127208	153,18	128208	274,12
46	127209	194,65	128209	325,94
50	127210	214,23	128210	360,50
52	127218	248,52	128218	403,91
55	127211	271,50	128211	443,42

mm	AL-BR		CU-BE	
	Cód.	P.V.P. unid. €	Cód.	P.V.P. unid. €
60	127212	306,36	128212	517,13
65	127213	390,44	128213	655,34
70	127214	458,40	128214	740,57
75	127215	534,41	128215	832,71
80	127216	659,95	128216	1.037,72
85	127219	795,31	128219	1.277,64
90	127655	947,73	128655	1.521,39
95	127656	1.090,97	128656	1.751,52
100	127657	1.269,89	128657	2.039,43
110	127658	1.589,11	128658	2.550,87
120	127659	1.747,44	128659	2.804,93
130	127660	2.004,44	128660	3.215,09
140	127661	2.243,06	128661	3.597,64
150	127662	2.516,25	128662	4.038,00



LLAVE DE ESTRELLA PLANA DE GOLPE

Ø mm	AL-BR		CU-BE	
	Cód.	P.V.P. unid. €	Cód.	P.V.P. unid. €
17	127230	55,28	128230	90,99
19	127231	61,04	128231	99,05
22	127232	63,35	128232	104,81
24	127233	72,56	128233	118,63
27	127234	87,53	128234	137,06
30	127235	101,35	128235	158,94
32	127236	110,57	128236	177,37
34	127250	123,34	128250	200,65
36	127237	125,54	128237	211,92
38	127251	158,33	128251	258,10
41	127238	164,70	128238	312,12
46	127239	181,98	128239	340,92
50	127240	217,68	128240	401,96
52	127241	269,51	128241	501,01
55	127242	275,27	128242	505,62

Ø mm	AL-BR		CU-BE	
	Cód.	P.V.P. unid. €	Cód.	P.V.P. unid. €
60	127243	286,79	128243	535,56
65	127244	332,86	128244	552,84
70	127245	383,53	128245	655,34
75	127246	438,82	128246	711,78
80	127247	477,98	128247	778,58
85	127252	604,93	128252	969,83
90	127248	680,68	128248	1.147,14
95	127253	828,83	128253	1.328,07
100	127249	953,65	128249	1.478,84
105	127254	1.050,11	128254	1.684,85
110	127255	1.205,83	128255	1.934,88
120	127256	1.432,66	128256	2.298,63
130	127257	1.685,59	128257	2.704,38
140	127258	1.943,69	128258	3.117,88
150	127259	2.229,07	128259	3.578,14



LLAVE AJUSTABLE



L mm	L"	AL-BR		CU-BE	
		Cód.	P.V.P. unid. €	Cód.	P.V.P. unid. €
100	4	127665	71,80	128665	137,33
150	6	127666	93,17	128666	156,86
200	8	127160	118,63	128160	176,22
250	10	127161	156,64	128161	217,68
300	12	127162	193,49	128162	260,30
375	15	127163	286,79	128163	390,44
450	18	127667	449,58	128667	624,46
600	24	127668	795,31	128668	1.108,26



LLAVE DE CARRACA DE ANDAMIO



Ø mm	AL-BR		CU-BE	
	Cód.	P.V.P. unid. €	Cód.	P.V.P. unid. €
14x17	127670	248,52	128670	419,37
17x19	127671	262,14	128671	439,27
19x22	127199	268,96	128199	474,71
22x24	127672	288,28	128672	503,32
24x27	127673	300,06	128673	527,99
27x30	127674	312,21	128674	547,89
30x32	127675	324,00	128675	570,72
32x36	127676	352,01	128676	618,19
36x41	127677	397,64	128677	670,13



LLAVE DE GANCHO FIJA



Ø mm	AL-BR		CU-BE	
	Cód.	P.V.P. unid. €	Cód.	P.V.P. unid. €
30-32	127680	66,26	128680	104,59
34-36	127681	81,75	128681	133,29
40-42	127682	100,51	128682	156,49
45-50	127683	115,60	128683	181,90
52-55	127684	130,72	128684	207,30
58-62	127685	142,14	128685	223,85
68-75	127686	150,21	128686	238,94
80-90	127687	172,68	128687	272,82
95-100	127688	191,85	128688	307,44
110-115	127689	211,34	128689	343,53
120-130	127690	234,90	128690	384,75
135-145	127691	275,03	128691	447,34



LLAVE DE GANCHO ARTICULADA



Ø mm	AL-BR		CU-BE	
	Cód.	P.V.P. unid. €	Cód.	P.V.P. unid. €
19-50	127695	123,34	128695	196,25
32-75	127696	127,01	128696	206,93
50-120	127697	200,65	128697	326,61
115-170	127698	344,63	128698	547,16

DINAMOMÉTRICA CON VISOR

■"	Cap. Nm	AL-BR		CU-BE	
		Cód.	P.V.P. unid. €	Cód.	P.V.P. unid. €
1/4	2-10	127700	2.195,92	128700	3.260,02
3/8	5-50	127701	2.521,75	128701	3.738,31
1/2	10-100	127702	2.934,15	128702	4.430,87
1/2	20-200	127703	3.189,68	128703	4.752,66
1/2	60-300	127704	3.441,14	128704	5.072,25
3/4	150-750	127705	10.226,26	128705	15.764,65
1	200-900	127706	11.615,45	128706	18.593,52

LLAVE STILLSON

L mm	L"	AL-BR		CU-BE	
		Cód.	P.V.P. unid. €	Cód.	P.V.P. unid. €
200	8	127708	153,15	128708	228,66
250	10	127170	201,56	128170	275,27
300	12	127709	244,49	128709	364,53
350	14	127171	322,49	128171	446,88
450	18	127172	454,94	128172	678,38
600	24	127173	669,17	128173	961,71
900	36	127710	1.057,45	128710	1.604,97
1200	48	127711	1.640,33	128711	2.610,52

LLAVE STILLSON DE AJUSTE TRANSVERSAL

L mm	L"	AL-BR		CU-BE	
		Cód.	P.V.P. unid. €	Cód.	P.V.P. unid. €
200	8	127715	123,34	128715	199,18
250	10	127716	180,43	128716	295,66
300	12	127717	255,90	128717	417,53
375	15	127718	396,17	128718	643,96
450	18	127719	547,89	128719	895,09

LLAVE ALLEN DE BOLA ACODADA

mm	AL-BR		CU-BE	
	Cód.	P.V.P. unid. €	Cód.	P.V.P. unid. €
2	127730	50,07	128730	81,39
3	127731	54,84	128731	87,99
4	127732	57,82	128732	92,44
5	127733	58,92	128733	94,64
6	127734	61,49	128734	98,67
7	127735	64,79	128735	104,59
8	127736	66,63	128736	107,89
9	127737	70,34	128737	113,03
10	127738	71,80	128738	117,84
11	127739	79,51	128739	128,48
12	127740	86,52	128740	138,80

LLAVE ALLEN ACODADA

mm	AL-BR		CU-BE	
	Cód.	P.V.P. unid. €	Cód.	P.V.P. unid. €
1.5	127745	32,42	128745	52,27
2	127270	34,68	128270	56,44
2.5	127746	36,45	128746	58,55
3	127271	37,12	128271	61,04
4	127272	38,48	128272	63,35
5	127273	39,56	128273	66,23
6	127274	40,01	128274	69,68
7	127275	41,98	128275	73,71
8	127276	46,59	128276	79,47
9	127277	50,21	128277	87,53
10	127278	53,82	128278	112,87

mm	AL-BR		CU-BE	
	Cód.	P.V.P. unid. €	Cód.	P.V.P. unid. €
11	127747	58,92	128747	114,64
12	127279	65,02	128279	131,30
13	127748	74,01	128748	141,88
14	127280	87,41	128280	148,58
15	127749	90,56	128749	154,75
16	127750	101,61	128750	164,93
17	127281	103,30	128281	171,61
18	127751	111,93	128751	183,73
19	127282	117,03	128282	196,95
21	127752	130,72	128752	210,60
22	127753	138,80	128753	226,06



LLAVE TORX ACODADA



★	AL-BR		CU-BE	
	Cód.	P.V.P. unid. €	Cód.	P.V.P. unid. €
T6	127760	46,03	128760	71,44
T7	127761	46,40	128761	71,80
T8	127762	48,24	128762	72,91
T9	127763	50,44	128763	75,47
T10	127764	51,17	128764	79,14
T15	127765	52,64	128765	83,22
T20	127766	54,84	128766	86,89
T25	127767	56,35	128767	94,64

★	AL-BR		CU-BE	
	Cód.	P.V.P. unid. €	Cód.	P.V.P. unid. €
T27	127768	60,02	128768	98,67
T30	127769	64,06	128769	102,71
T40	127770	74,37	128770	114,86
T45	127771	85,42	128771	125,55
T50	127772	98,31	128772	141,00
T55	127773	108,99	128773	160,53
T60	127774	119,31	128774	175,98



DESTORNILLADOR BOCA RECTA



⌀ x	AL-BR		CU-BE	
	mm	mm	Cód.	P.V.P. unid. €
3,0x50	127300	18,43	128300	29,07
4,0x100	127302	29,44	128302	45,67
6,0x100	127304	44,93	128304	67,77



DESTORNILLADOR BOCA PLANA



⌀ x	AL-BR		CU-BE	
	mm	mm	Cód.	P.V.P. unid. €
3,0x75	127310	20,73	128310	32,25
5,0x100	127311	27,49	128311	42,61
6,0x150	127312	35,40	128312	55,83
7,0x150	127307	36,45	128307	56,35
8,0x200	127313	50,68	128313	74,86
9,0x250	127308	58,92	128308	88,36
10,0x300	127309	70,70	128309	107,89



DESTORNILLADOR BOCA PHILLIPS



⊕ x	AL-BR		CU-BE	
	mm	Cód.	P.V.P. unid. €	Cód.
PH0x50	127315	21,00	128315	30,54
PH1x100	127316	27,19	128316	39,01
PH2x150	127317	35,67	128317	49,67
PH3x200	127318	43,65	128318	79,47
PH4x300	127319	71,44	128319	110,09



DESTORNILLADOR BOCA POZIDRIVE



⊕ x	AL-BR		CU-BE	
	mm	Cód.	P.V.P. unid. €	Cód.
PZ0x50	127800	19,90	128800	29,81
PZ1x75	127801	21,73	128801	35,72
PZ2x100	127802	37,55	128802	45,67
PZ3x150	127803	39,76	128803	61,49
PZ4x200	127804	48,60	128804	72,54



DESTORNILLADOR BOCA TORX

Al-Br Cu-Be



x mm	AL-BR		CU-BE	
	Cód.	P.V.P. unid. €	Cód.	P.V.P. unid. €
T10x75	127805	29,81	128805	46,03
T15x75	127806	32,42	128806	48,60
T20x100	127807	43,47	128807	67,77
T25x125	127808	47,87	128808	72,17
T30x150	127809	54,84	128809	79,14
T40x200	127810	62,59	128810	95,37
T45x250	127811	70,34	128811	106,42
T50x300	127812	75,11	128812	115,23
T55x350	127813	86,16	128813	133,29
T60x400	127814	97,57	128814	148,75



DESTORNILLADOR CON VASO HEXAGONAL

Al-Br Cu-Be



x mm	AL-BR		CU-BE	
	Cód.	P.V.P. unid. €	Cód.	P.V.P. unid. €
6,0x90	127815	70,70	128815	108,26
8,0x100	127816	75,47	128816	115,23
10,0x110	127817	85,42	128817	129,62
13,0x110	127818	96,84	128818	145,08
16,0x120	127819	104,18	128819	158,70
17,0x120	127820	109,72	128820	168,28



LLAVE DE VASO DE 1/2"

Al-Br Cu-Be

■ Llave de vaso de 12 caras.



mm	AL-BR		CU-BE	
	Cód.	P.V.P. unid. €	Cód.	P.V.P. unid. €
8	127510	37,55	128510	64,79
9	127511	40,49	128511	68,87
10	127512	43,47	128512	71,44
11	127513	44,93	128513	75,84
12	127514	47,87	128514	80,65
13	127515	51,17	128515	86,89
14	127516	54,84	128516	91,29
15	127517	55,98	128517	94,64
16	127518	59,29	128518	99,78
17	127519	62,59	128519	103,45
18	127520	63,69	128520	107,89
19	127521	66,26	128521	112,29

mm	AL-BR		CU-BE	
	Cód.	P.V.P. unid. €	Cód.	P.V.P. unid. €
20	127522	70,34	128522	118,94
21	127523	70,70	128523	122,24
22	127524	71,07	128524	125,55
23	127525	78,41	128525	137,33
24	127526	85,42	128526	148,75
25	127527	90,19	128527	162,36
26	127528	97,57	128528	171,95
27	127529	104,18	128529	183,73
28	127530	109,72	128530	192,21
29	127531	116,33	128531	206,93
30	127532	123,34	128532	218,72
32	127533	138,43	128533	245,59



LLAVE DE VASO DE 3/4"

Al-Br Cu-Be

■ Llave de vaso de 12 caras.



mm	AL-BR		CU-BE	
	Cód.	P.V.P. unid. €	Cód.	P.V.P. unid. €
17	127535	75,47	128535	131,09
19	127536	77,68	128536	131,46
21	127537	85,42	128537	145,08
22	127538	88,36	128538	148,75
23	127539	89,09	128539	152,78
24	127540	96,84	128540	164,57
26	127541	111,93	128541	191,48
27	127542	116,74	128542	202,90
28	127543	123,34	128543	211,70
29	127544	131,09	128544	226,06

mm	AL-BR		CU-BE	
	Cód.	P.V.P. unid. €	Cód.	P.V.P. unid. €
30	127545	138,80	128545	239,35
31	127546	149,85	128546	254,43
32	127547	157,23	128547	269,89
34	127548	169,01	128548	291,99
36	127549	180,43	128549	311,85
38	127550	192,95	128550	334,31
41	127551	214,27	128551	366,36
46	127552	252,23	128552	434,82
50	127553	275,76	128553	474,62



LLAVE DE VASO DE 1/2" - PULGADAS



Ø"	AL-BR		CU-BE	
	Cód.	P.V.P. unid. €	Cód.	P.V.P. unid. €
5/16	127555	47,50	128555	77,31
3/8	127556	48,60	128556	83,22
7/16	127557	56,35	128557	90,93
1/2	127558	64,06	128558	94,64
9/16	127559	74,01	128559	102,34
5/8	127560	79,14	128560	121,88
11/16	127561	85,42	128561	129,62
3/4	127562	89,83	128562	141,00
13/16	127563	96,84	128563	148,75
7/8	127564	101,61	128564	160,53
15/16	127565	108,99	128565	171,95
1	127566	111,93	128566	191,48
1-1/16	127567	121,14	128567	206,93
1-1/4	127568	158,33	128568	272,46
1-7/16	127569	195,15	128569	334,68



LLAVE DE VASO DE 3/4" - PULGADAS



Ø"	AL-BR		CU-BE	
	Cód.	P.V.P. unid. €	Cód.	P.V.P. unid. €
3/4	127570	96,84	128570	145,08
13/16	127571	100,88	128571	156,86
7/8	127572	108,26	128572	164,57
15/16	127573	115,60	128573	177,45
1	127574	119,31	128574	203,26
1-1/16	127575	130,72	128575	222,39
1-1/8	127576	134,76	128576	237,84
1-3/16	127577	153,56	128577	273,56
1-1/4	127578	166,44	128578	296,02
1-5/16	127579	187,77	128579	327,71
1-3/8	127580	196,25	128580	342,79
1-7/16	127581	199,92	128581	349,81
1-1/2	127582	210,60	128582	366,36
1-5/8	127583	226,79	128583	403,91
1-3/4	127584	245,95	128584	435,19
1-13/16	127585	265,12	128585	469,81
1-7/8	127586	276,90	128586	493,01
2	127587	301,57	128587	535,37



LLAVE DE VASO DE IMPACTO DE 1/2"



Ø mm	AL-BR		CU-BE	
	Cód.	P.V.P. unid. €	Cód.	P.V.P. unid. €
8	127430	51,17	128430	83,59
10	127431	55,25	128431	92,44
12	127432	62,59	128432	104,59
14	127433	70,34	128433	118,21
17	127434	81,39	128434	134,39
19	127435	86,52	128435	145,44
22	127436	93,17	128436	162,00
24	127437	109,72	128437	192,58
27	127438	135,49	128438	237,84
30	127439	161,26	128439	284,24
32	127440	180,06	128440	315,56



LLAVE DE VASO DE IMPACTO DE 3/4"



Ø mm	AL-BR		CU-BE	
	Cód.	P.V.P. unid. €	Cód.	P.V.P. unid. €
24	127445	111,93	128445	199,18
27	127446	138,43	128446	245,59
30	127447	162,73	128447	285,71
32	127448	181,53	128448	316,66
36	127449	200,65	128449	350,17
41	127450	234,54	128450	403,91
46	127451	270,99	128451	477,55
50	127452	291,62	128452	523,96



LLAVE DE VASO DE IMPACTO DE 1/2", SERIE LARGA



Ø mm	AL-BR		CU-BE	
	Cód.	P.V.P. unid. €	Cód.	P.V.P. unid. €
8	127455	78,78	128455	133,66
10	127456	89,09	128456	148,75
12	127457	100,51	128457	168,28
14	127458	112,66	128458	188,50
17	127459	127,75	128459	214,64
19	127460	138,80	128460	233,80
22	127461	149,85	128461	261,04
24	127462	176,35	128462	307,81
27	127463	217,98	128463	377,78
30	127464	257,74	128464	454,35
32	127465	286,44	128465	505,52



LLAVE DE VASO DE IMPACTO DE 3/4", SERIE LARGA



Ø mm	AL-BR		CU-BE	
	Cód.	P.V.P. unid. €	Cód.	P.V.P. unid. €
17	127471	142,14	128471	185,20
19	127472	153,92	128472	230,87
22	127473	169,75	128473	284,24
24	127474	180,06	128474	322,90
27	127475	222,02	128475	396,90
30	127476	263,61	128476	470,91
32	127477	290,89	128477	528,73
36	127478	346,83	128478	612,68
41	127479	412,76	128479	720,94
46	127480	476,45	128480	849,79
50	127481	515,47	128481	931,91



LLAVE DE CARRACA



" "	AL-BR		CU-BE	
	Cód.	P.V.P. unid. €	Cód.	P.V.P. unid. €
3/8	127504	125,91	128504	213,54
1/2	127502	206,16	128502	319,82
3/4	127503	404,26	128503	588,92
1	127505	737,49	128505	1.242,65



ALARGADERA



" "	L mm	AL-BR		CU-BE	
		Cód.	P.V.P. unid. €	Cód.	P.V.P. unid. €
3/8	75	127365	49,70	128365	74,74
3/8	150	127366	61,49	128366	95,01
1/2	100	127367	74,01	128367	115,23
1/2	125	127368	90,56	128368	122,61
1/2	200	127369	121,14	128369	165,30
1/2	250	127370	141,00	128370	177,08
3/4	200	127371	173,05	128371	252,60
3/4	430	127373	428,58	128373	635,51
1	200	127372	237,10	128372	379,61



JUNTA UNIVERSAL



" "	AL-BR		CU-BE	
	Cód.	P.V.P. unid. €	Cód.	P.V.P. unid. €
1/2	127375	81,39	128375	129,62
3/4	127376	195,15	128376	326,61
1	127377	398,37	128377	606,40



ADAPTADOR



Hembra	Macho	AL-BR		CU-BE	
		Cód.	P.V.P. unid. €	Cód.	P.V.P. unid. €
3/8	1/4	127380	40,12	128380	60,75
1/4	3/8	127381	41,76	128381	61,86
1/2	3/8	127382	55,25	128382	81,35
3/8	1/2	127383	58,92	128383	90,93
3/4	1/2	127384	86,89	128384	133,29
1/2	3/4	127385	102,59	128385	142,34
1	3/4	127386	154,66	128386	218,35
3/4	1	127387	159,36	128387	229,18
1-1/2	1	127388	332,11	128388	543,08
1	1-1/2	127389	339,91	128389	572,24



MANGO EN I



" "	L mm	AL-BR		CU-BE	
		Cód.	P.V.P. unid. €	Cód.	P.V.P. unid. €
1/2	250	127390	134,76	128390	219,08
3/4	350	127391	203,26	128391	326,97
3/4	400	127392	246,69	128392	400,24
1	400	127393	291,62	128393	469,81



MANGO ARTICULADO



" "	L mm	AL-BR		CU-BE	
		Cód.	P.V.P. unid. €	Cód.	P.V.P. unid. €
3/8	190	127394	70,34	128394	114,86
1/2	250	127395	96,84	128395	156,86
1/2	320	127396	120,41	128396	196,62
1/2	400	127397	170,11	128397	280,20
3/4	300	127398	180,06	128398	291,99
1	300	127399	253,33	128399	411,66



JUEGO DE LLAVES DE VASO DE 1/2"

COMPOSICIÓN

- 11 vasos 1/2": 10, 11, 12, 14, 17, 19, 22, 24, 27, 30 y 32 mm.
- 1 llave de carraca 1/2" de 245 mm.
- 2 alargaderas 1/2" de 125 y 250 mm.
- 1 mango en T 1/2" de 250 mm.
- 1 berbiquí 1/2" de 400 mm.



Nº Piezas	AL-BR		CU-BE	
	Cód.	P.V.P. unid. €	Cód.	P.V.P. unid. €
16	127498	1.853,86	128498	2.855,37



JUEGO DE LLAVES DE VASO DE 1/2"

COMPOSICIÓN

- 18 vasos 1/2": 10, 11, 12, 13, 14, 15, 16, 17, 18, 19, 20, 21, 22, 23, 24, 27, 30 y 32 mm.- 1 llave de carraca 1/2" de 245 mm.
- 2 alargaderas 1/2" de 125 y 250 mm.- 1 mango en T 1/2" de 250 mm. - 1 berbiquí 1/2" de 400 mm.- 1 junta universal 1/2" de 80 mm.



Nº Piezas	AL-BR		CU-BE	
	Cód.	P.V.P. unid. €	Cód.	P.V.P. unid. €
24	127500	2.692,79	128500	4.029,97



JUEGO DE LLAVES DE VASO DE 1/2"

COMPOSICIÓN

- 22 vasos 1/2": 8, 9, 10, 11, 12, 13, 14, 15, 16, 17, 18, 19, 20, 21, 22, 23, 24, 26, 27, 28, 30 y 32 mm. - 1 llave de carraca 1/2" de 245 mm.
- 2 alargaderas 1/2" de 125 y 250 mm. - 1 mango en T 1/2" de 250 mm. - 1 berbiquí 1/2" de 400 mm. - 1 junta universal 1/2" de 80 mm.
- 1 mango acodado 1/2" de 230 mm. - 1 vaso 1/2" con punta plana 13,0 x 52 mm. - 1 llave de bujía 1/2" x 13/16"



Nº Piezas	AL-BR		CU-BE	
	Cód.	P.V.P. unid. €	Cód.	P.V.P. unid. €
31	127499	2.939,29	128499	4.641,10



JUEGO DE LLAVES DE VASO DE 3/4"

COMPOSICIÓN

- 11 vasos 3/4": 21, 24, 27, 30, 32, 34, 36, 38, 41, 46 y 50 mm.
- 1 llave de carraca 3/4" de 320 mm.
- 1 alargadera 3/4" de 200 mm.
- 1 mango en T 3/4" de 400 mm.



Nº Piezas	AL-BR		CU-BE	
	Cód.	P.V.P. unid. €	Cód.	P.V.P. unid. €
14	127501	3.510,53	128501	4.663,56



Al-Br



Cu-Be

MACETA OCTOGONAL



Peso grs.	AL-BR		CU-BE	
	Cód.	P.V.P. unid. €	Cód.	P.V.P. unid. €
450	127830	63,69	128830	104,59
1000	127412	137,06	128412	259,14
1400	127831	187,77	128831	304,51
1500	127413	199,25	128413	332,86
1800	127832	237,10	128832	396,17
2000	127414	256,81	128414	399,66
2200	127833	286,44	128833	455,82
2500	127415	294,50	128415	499,86
2700	127834	346,83	128834	516,21
3000	127416	377,82	128416	615,03
3600	127835	457,66	128835	701,77

Peso grs.	AL-BR		CU-BE	
	Cód.	P.V.P. unid. €	Cód.	P.V.P. unid. €
4000	127836	517,68	128836	840,98
4500	127417	563,47	128417	886,38
5000	127418	574,72	128418	1.026,21
5400	127837	689,62	128837	1.107,52
6400	127838	817,41	128838	1.339,49
7200	127839	919,76	128839	1.474,98
8000	127419	1.033,12	128419	1.716,10
8200	127840	1.046,40	128840	1.731,62
9100	127841	1.162,41	128841	1.908,34
9900	127420	1.202,42	128420	2.176,80



Al-Br



Cu-Be

MARTILLO DE BOLA



Peso grs.	AL-BR		CU-BE	
	Cód.	P.V.P. unid. €	Cód.	P.V.P. unid. €
230	127842	36,09	128842	57,08
340	127843	52,64	128843	83,22
450	127406	66,80	128406	150,88
680	127407	101,35	128407	178,52
910	127408	128,67	128408	217,68
1130	127409	156,84	128409	260,30



Al-Br



Cu-Be

MARTILLO DE MECÁNICO



Peso grs.	AL-BR		CU-BE	
	Cód.	P.V.P. unid. €	Cód.	P.V.P. unid. €
500	127400	88,68	128400	116,33
1000	127401	160,09	128401	214,23
1500	127402	228,05	128402	340,92
2000	127403	286,79	128403	448,03
3000	127844	464,67	128844	726,44
5000	127845	762,16	128845	1.196,66



Al-Br



Cu-Be

MARTILLO DE DESCAMACIÓN



Peso grs.	AL-BR		CU-BE	
	Cód.	P.V.P. unid. €	Cód.	P.V.P. unid. €
150	127846	36,82	128846	60,02
300	127847	66,63	128847	108,26



Al-Br



Cu-Be

MARTILLO DE BOCAS DE NYLON



Peso grs.	AL-BR		CU-BE	
	Cód.	P.V.P. unid. €	Cód.	P.V.P. unid. €
800	127425	138,21	128425	202,71
1000	127848	149,85	128848	234,54



ALCOTANA PALA-PICO



Peso grs.	AL-BR		CU-BE	
	Cód.	P.V.P. unid. €	Cód.	P.V.P. unid. €
2000	127849	223,49	128849	370,40
2800	127850	335,78	128850	550,83
3200	127851	384,75	128851	616,72
3500	127852	481,22	128852	782,79



HACHA DE BOMBERO



Peso grs.	AL-BR		CU-BE	
	Cód.	P.V.P. unid. €	Cód.	P.V.P. unid. €
1800	127853	415,33	128853	601,26



RASQUETA



L mm	AL-BR		CU-BE	
	Cód.	P.V.P. unid. €	Cód.	P.V.P. unid. €
270	127360	102,51	128360	145,65



RASQUETA HOJA LARGA

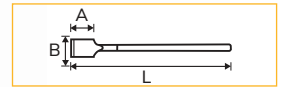

BxA mm	L mm	AL-BR		CU-BE	
		Cód.	P.V.P. unid. €	Cód.	P.V.P. unid. €
50x90	690	127854	104,95	128854	171,95
75x100	705	127361	138,21	128361	190,45
100x115	720	127362	165,85	128362	220,91
150x150	765	127363	263,75	128363	336,76



BOTADOR CILÍNDRICO



Ø mm	AL-BR		CU-BE	
	Cód.	P.V.P. unid. €	Cód.	P.V.P. unid. €
3	127855	13,62	128855	21,73
4	127856	32,78	128856	53,01
6	127857	51,91	128857	85,06
8	127858	60,02	128858	98,67
10	127859	74,74	128859	122,24
12	127860	100,51	128860	164,20
14	127861	127,01	128861	206,93
16	127862	158,33	128862	261,04
18	127863	191,48	128863	311,11
20	127864	199,18	128864	322,90



BOTADOR CÓNICO



Ø mm	AL-BR		CU-BE	
	Cód.	P.V.P. unid. €	Cód.	P.V.P. unid. €
5	127865	21,00	128865	30,95
6	127866	22,47	128866	36,82
7	127867	25,77	128867	41,96
8	127868	29,44	128868	48,24
10	127869	45,30	128869	75,47
12	127870	56,35	128870	94,64
13	127871	187,77	128871	303,40



CORTAFRÍOS

Al-Br Cu-Be

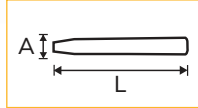

LxA mm	AL-BR		CU-BE	
	Cód.	P.V.P. unid. €	Cód.	P.V.P. unid. €
150x22	127325	61,04	128325	95,23
200x22	127326	67,95	128326	114,55
250x24	127327	108,26	128327	170,93
300x25	127872	165,30	128872	272,46
400x27	127873	214,64	128873	350,91



BURIL

Al-Br Cu-Be



L mm	AL-BR		CU-BE	
	Cód.	P.V.P. unid. €	Cód.	P.V.P. unid. €
140	127874	54,84	128874	85,06
200	127875	86,89	128875	137,33
300	127876	142,87	128876	226,79



CUÑA

Al-Br Cu-Be

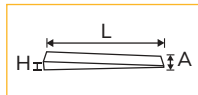

LxA mm H mm	AL-BR		CU-BE	
	Cód.	P.V.P. unid. €	Cód.	P.V.P. unid. €
100x50 10-0	127284	29,95	128284	62,19
135x50 18-0	127285	73,71	128285	148,58
150x40 8-0	127286	34,54	128286	49,53
150x25 8-0	127287	20,73	128287	41,46
150x25 13-0	127288	34,55	128288	62,19
150x50 13-0	127289	64,50	128289	111,72
180x13 6-0	127290	29,95	128290	61,04
180x32 13-0	127291	48,37	128291	77,17

LxA mm H mm	AL-BR		CU-BE	
	Cód.	P.V.P. unid. €	Cód.	P.V.P. unid. €
180x50 19-0	127292	111,72	128292	171,61
200x20 30-0	127293	79,47	128293	141,67
200x30 30-0	127294	119,78	128294	202,71
200x40 40-0	127295	206,16	128295	269,51
200x50 12-0	127296	79,47	128296	132,45
230x40 20-0	127297	120,93	128297	196,95
250x40 30-0	127298	194,65	128298	294,85
300x50 40-0	127299	349,90	128299	528,65



CEPILLO CIRCULAR

Lt Cu



CEPILLO CIRCULAR CON VÁSTAGO

Lt Cu



Ø mm	LT		CU	
	Cód.	P.V.P. unid. €	Cód.	P.V.P. unid. €
125	127880	350,91	128880	554,86

Ø mm	LT		CU	
	Cód.	P.V.P. unid. €	Cód.	P.V.P. unid. €
75	127881	153,56	128881	241,55



CEPILLO DE TAZA ONDULADA



Ø mm	LT		CU	
	Cód.	P.V.P. unid. €	Cód.	P.V.P. unid. €
100	127882	331,74	128882	527,62



CEPILLO DE TAZA TRENZADO



Ø mm	LT		CU	
	Cód.	P.V.P. unid. €	Cód.	P.V.P. unid. €
100	127883	525,42	128883	829,93



CEPILLO DE BROCHA ONDULADO



Ø mm	LT		CU	
	Cód.	P.V.P. unid. €	Cód.	P.V.P. unid. €
26	127884	136,23	128884	216,15



CEPILLO MANUAL



L mm	LT		CU	
	Cód.	P.V.P. unid. €	Cód.	P.V.P. unid. €
205	127885	96,84	128885	153,15



CEPILLO MANUAL CON MANGO DE MADERA



L mm	LT		CU	
	Cód.	P.V.P. unid. €	Cód.	P.V.P. unid. €
290	127886	51,17	128886	80,65



CEPILLO MANUAL ACODADO CON MANGO DE MADERA



L mm	LT		CU	
	Cód.	P.V.P. unid. €	Cód.	P.V.P. unid. €
196	127887	16,92	128887	29,07



ARCO DE SIERRA



L mm	AL-BR		CU-BE	
	Cód.	P.V.P. unid. €	Cód.	P.V.P. unid. €
500	127890	248,60	128890	392,58



HOJA DE SIERRA



L mm	CU-BE	
	Cód.	P.V.P. unid. €
300	128891	83,22



PALA REDONDA, MANGO ANILLA

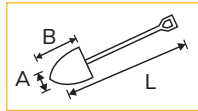

AxBxL mm	AL-BR		CU-BE	
	Cód.	P.V.P. unid. €	Cód.	P.V.P. unid. €
240x420x990	127600	325,78	128600	423,67



PALA CUADRADA, MANGO ANILLA

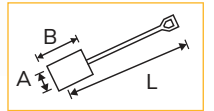

AxBxL mm	AL-BR		CU-BE	
	Cód.	P.V.P. unid. €	Cód.	P.V.P. unid. €
175x340x940	127895	225,69	128895	411,66
240x418x990	127896	290,15	128896	528,73



RASTRILLO, MANGO DE MADERA

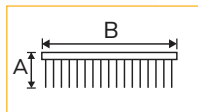

BxA mm	AL-BR		CU-BE	
	Cód.	P.V.P. unid. €	Cód.	P.V.P. unid. €
350x100	127898	305,61	128898	477,55
450x120	127899	346,83	128899	540,51



CUCHILLO



L mm	Filo mm	AL-BR		CU-BE	
		Cód.	P.V.P. unid. €	Cód.	P.V.P. unid. €
193	80	127900	81,39	128900	129,62
250	137	127901	100,51	128901	148,75



ESPÁTULA

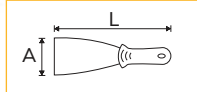

AxL mm	AL-BR		CU-BE	
	Cód.	P.V.P. unid. €	Cód.	P.V.P. unid. €
25x200	127350	50,68	128350	94,44
30x200	127351	54,13	128351	99,05
40x200	127352	58,34	128352	108,26
50x200	127353	72,56	128353	114,02
60x200	127354	84,08	128354	124,39
65x200	127358	89,46	128358	131,09



ESPÁTULA ANCHA

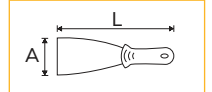

AxL mm	AL-BR		CU-BE	
	Cód.	P.V.P. unid. €	Cód.	P.V.P. unid. €
75x200	127355	90,44	128355	167,00
80x200	127356	95,60	128356	190,04
100x200	127357	101,35	128357	201,56
150x250	127359	196,98	128359	295,66



TORNILLO DE APRIETE



AxB mm	AL-BR		CU-BE	
	Cód.	P.V.P. unid. €	Cód.	P.V.P. unid. €
400x120	127905	483,43	128905	736,39



REGLA



L mm	AL-BR		CU-BE	
	Cód.	P.V.P. unid. €	Cód.	P.V.P. unid. €
500	127907	237,10	128907	350,17
1000	127908	382,18	128908	585,81



ESCUADRA



LxA mm	AL-BR		CU-BE	
	Cód.	P.V.P. unid. €	Cód.	P.V.P. unid. €
300x150	127909	403,91	128909	532,76
500x250	127910	616,72	128910	918,29



GALGA ESPESORES

■ 9 piezas.



Medidas mm	Lt	
	Cód.	P.V.P. unid. €
0,05 a 1,00	127912	110,09



EXTRACTOR DE 2 PATAS



L mm	AL-BR		CU-BE	
	Cód.	P.V.P. unid. €	Cód.	P.V.P. unid. €
100	127915	590,95	128915	965,79
150	127916	737,49	128916	1.204,36
200	127917	794,94	128917	1.300,84
350	127918	1.420,14	128918	2.318,90



EXTRACTOR DE 3 PATAS



L mm	AL-BR		CU-BE	
	Cód.	P.V.P. unid. €	Cód.	P.V.P. unid. €
100	127920	701,04	128920	1.146,18
150	127921	773,21	128921	1.262,92
200	127922	879,27	128922	1.436,70
350	127923	1.663,16	128923	2.715,80



BARRA DE DESENCOFRAR



L mm	AL-BR		CU-BE	
	Cód.	P.V.P. unid. €	Cód.	P.V.P. unid. €
400	127925	134,76	128925	219,08
600	127926	191,85	128926	315,19
800	127927	381,08	128927	622,63
1200	127928	620,06	128928	1.012,56



BARRA EN PUNTA



L x Ø mm	AL-BR		CU-BE	
	Cód.	P.V.P. unid. €	Cód.	P.V.P. unid. €
500x15	127930	104,18	128930	168,28
500x19	127931	161,26	128931	262,14
500x20	127932	180,06	128932	291,99
500x23	127933	237,10	128933	386,63
600x25	127934	324,36	128934	528,73
800x23	127935	365,99	128935	594,98
1000x30	127936	786,83	128936	1.282,81



TORNILLO DE BANCO DE GUÍA CUADRADA

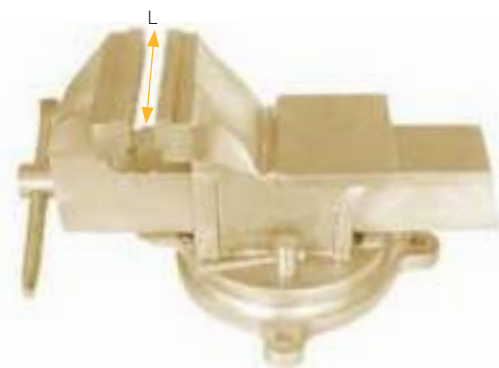

L mm	AL-BR		CU-BE	
	Cód.	P.V.P. unid. €	Cód.	P.V.P. unid. €
90	127940	3.312,66	128940	5.012,23
125	127941	5.497,17	128941	8.310,17
150	127942	8.179,45	128942	12.373,21
170	127943	11.151,56	128943	16.869,64



EMBUDO PARA ACEITE



L x ø mm	LT		CU	
	Cód.	P.V.P. unid. €	Cód.	P.V.P. unid. €
130x160	127945	81,39	128945	106,42
150x160	127946	85,42	128946	110,09



CAZO PARA ACEITE

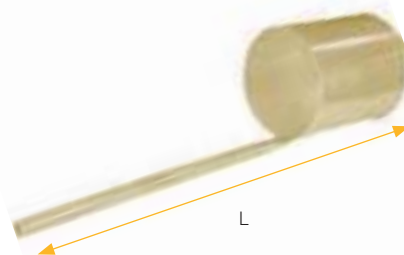

L x ø mm	LT		CU	
	Cód.	P.V.P. unid. €	Cód.	P.V.P. unid. €
350x85	127950	55,98	128950	79,14



ACEITERA PEQUEÑA



Litros	LT		CU	
	Cód.	P.V.P. unid. €	Cód.	P.V.P. unid. €
2	127952	280,57	128952	396,17



ACEITERA GRANDE



Litros	LT		CU	
	Cód.	P.V.P. unid. €	Cód.	P.V.P. unid. €
10	127954	498,55	128954	794,58



BIDON



Litros	LT		CU	
	Cód.	P.V.P. unid. €	Cód.	P.V.P. unid. €
10	127956	426,75	128956	595,39



CUBO REDONDO



Litros	LT		CU	
	Cód.	P.V.P. unid. €	Cód.	P.V.P. unid. €
14	127958	381,08	128958	485,30



CUBO CÓNICO

Lt

Cu



Litros	LT		CU	
	Cód.	P.V.P. unid. €	Cód.	P.V.P. unid. €
10	127960	282,41	128960	393,97
15	127961	365,99	128961	512,17



RECOGEDOR

Lt

Cu



LxA mm	LT		CU	
	Cód.	P.V.P. unid. €	Cód.	P.V.P. unid. €
150x130	127965	92,80	128965	125,55
200x200	127966	127,01	128966	179,69
270x250	127967	199,18	128967	269,89



POLIPASTO DE CADENA

Al-Br

Cu-Be

Capacidad Tn	M	AL-BR		CU-BE	
		Cód.	P.V.P. unid. €	Cód.	P.V.P. unid. €
0,5	2,5	127970	3.638,86	128970	4.874,17
1,0	2,5	127971	3.786,91	128971	5.012,23
1,5	2,5	127972	4.352,46	128972	5.762,28
2,0	2,5	127973	5.341,77	128973	7.073,03
3,0	3,0	127974	6.548,38	128974	9.361,75
5,0	3,0	127975	8.038,45	128975	11.144,55
10,0	3,0	127976	20.285,38	128976	26.859,49
16,0	3,0	127977	39.216,88	128977	52.073,92



MACETA OCTOGONAL

Cu

- Dureza inferior al Al-Br y Cu-Be.
- Desgaste importante durante el uso.



MACETA OCTOGONAL

Lt

- Dureza inferior al Al-Br y Cu-Be.
- Desgaste importante durante el uso.



16

Peso grs.	CU	
	Cód.	P.V.P. unid. €
900	129120	108,26
1350	129121	149,73
1800	129122	195,80
4500	129123	449,18
7200	129124	650,74
9000	129125	784,34

Peso grs.	LT	
	Cód.	P.V.P. unid. €
900	129020	90,99
1350	129021	120,93
1800	129022	161,24
4500	129023	401,96
7200	129024	495,25
9000	129025	688,75

17

HERRAMIENTA DE TITANIO

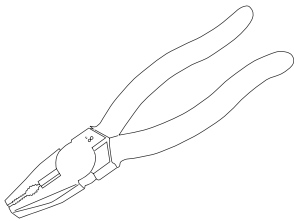

Alicata universal Ti **395**

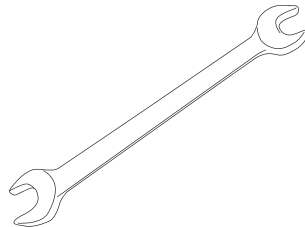

Llave fija Ti **396**

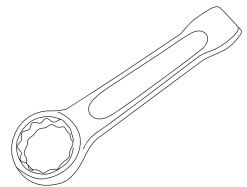

Llave estrella plana de golpe Ti **397**

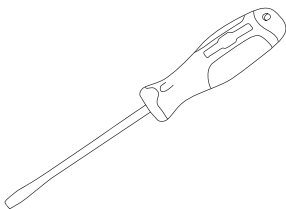

Destornillador boca plana Ti **398**

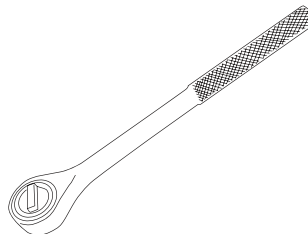

Llave de carraca Ti **399**

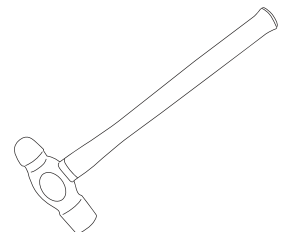

Martillo de bola Ti **400**

HERRAMIENTAS DE TITANIO



El TITANIO (Ti) es un elemento químico de color plateado, comparado, a menudo, con el acero por su dureza y resistencia a la corrosión. Debido a su estructura, se trata de un material no ferromagnético, es decir, que no se imanta. Es, además, refractario y **buen conductor del calor y de la electricidad**. Es un material altamente maleable que permite muchas configuraciones. Es muy duro y ligero, lo que hace que posea una alta relación resistencia/peso. **Su peso es un 45% menor que el del acero.**

Soporta altas temperaturas, ya que su punto de fusión es 1668°C y de ebullición 3287°C. **Es muy resistente a la erosión y a la corrosión atmosférica.** En presencia de oxígeno el titanio genera una capa de óxido de titanio (TiO₂), que es aislante y no permite que entren en el material elementos corrosivos.

Principales VENTAJAS y USOS de las herramientas de Titanio



BAJA DENSIDAD Y BAJO PESO

Las herramientas de TITANIO pesan un 45% menos que las herramientas en ACERO convencionales. Son adecuadas para la industria aeroespacial.

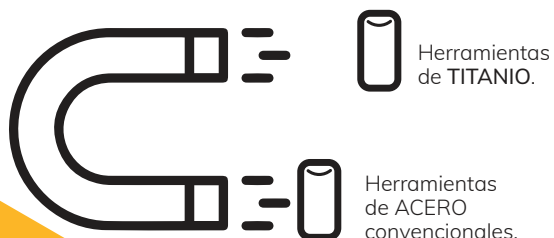

NO MAGNÉTICAS

Las herramientas de TITANIO NO se imantan. Son adecuadas en el mundo de la medicina: en aplicaciones como tratamientos de Resonancia Magnética, en intervenciones quirúrgicas, etc.

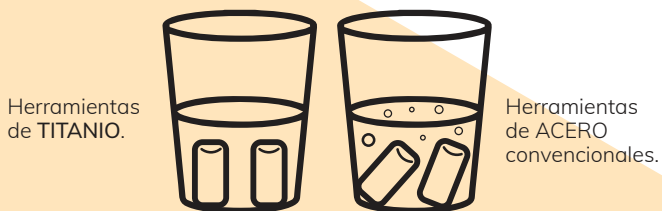

RESISTENTES A LA CORROSIÓN

Las herramientas de TITANIO son altamente resistentes a la corrosión, NO se oxidan. Son adecuadas para su uso con agua y en operaciones en aguas profundas.

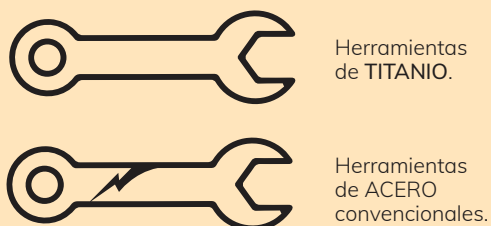

FUERTES, RESISTENTES y DURADERAS

Las herramientas de TITANIO son capaces de mantener estables sus propiedades físicas incluso en operaciones de altísimas exigencias o entornos muy hostiles. Son adecuadas para su uso en temperaturas extremadamente altas o bajas.





ALICATE UNIVERSAL

Ti



Cód.	L mm	L"	P.V.P. unid. €	
125200	150	6	645,83	1
125202	200	8	847,58	1



ALICATE UNIVERSAL AJUSTABLE

Ti



Cód.	L mm	L"	P.V.P. unid. €	
125210	150	6	604,57	1
125212	200	8	721,30	1
125214	250	10	897,66	1



ALICATE BOCAS SEMIREDONDAS CON CORTE

Ti



Cód.	L mm	L"	P.V.P. unid. €	
125220	150	6	657,61	1
125222	200	8	756,66	1



ALICATE CORTE DIAGONAL

Ti



Cód.	L mm	L"	P.V.P. unid. €	
125230	150	6	629,97	1
125232	200	8	744,51	1



ALICATE BOCAS REDONDAS

Ti



Cód.	L mm	L"	P.V.P. unid. €	
125235	150	6	663,12	1



ALICATE BOCAS PLANAS

Ti



Cód.	L mm	L"	P.V.P. unid. €	
125238	150	6	641,39	1
125240	200	8	758,86	1



TENAZA PICO LORO

Ti



Cód.	L mm	L"	P.V.P. unid. €	
125242	150	6	703,24	1
125244	200	8	847,58	1
125246	250	10	1.053,78	1



TENAZA GRIP BOCAS CURVAS

Ti



Cód.	L mm	L"	P.V.P. unid. €	
125248	225	9	1.051,58	1



ALICATE SEEGER BOCA RECTA

Ti 200 MM - 8"



Cód.	Tipo	P.V.P. unid. €	
125252	Interiores	956,21	1
125254	Exteriores	734,56	1



ALICATE PRENSA TERMINALES

Ti



Cód.	L mm	L"	P.V.P. unid. €	
125260	200	8	727,91	1



PINZA DE PRECISIÓN BOCA CURVA

Ti



Cód.	L mm	L"	P.V.P. unid. €	
125262	150	6	238,21	1
125264	200	8	358,61	1



CUCHILLO

Ti

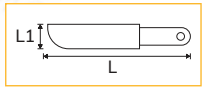

Cód.	L mm	L1 mm	P.V.P. unid. €	
125266	230	25	245,22	1
125268	250	30	262,14	1
125270	260	35	286,44	1



LLAVE FIJA DOS BOCAS

Cód.	Ø mm	L mm	P.V.P. unid. €	
125276	6x7	120	164,57	1
125278	7x9	135	195,88	1
125280	8x10	145	222,02	1
125282	10x12	165	274,29	1
125284	12x14	180	308,91	1
125286	14x17	195	360,82	1
125288	17x19	210	406,48	1
125290	19x22	225	480,49	1
125292	22x24	250	550,46	1
125294	24x27	270	679,67	1
125296	27x30	290	824,38	1
125298	30x32	310	942,59	1

Ti



LLAVE COMBINADA

Cód.	Ø mm	L mm	P.V.P. unid. €	
125302	6	105	154,66	1
125304	8	120	185,57	1
125306	10	135	233,44	1
125308	12	150	267,69	1
125310	14	175	290,89	1
125312	17	195	332,11	1
125314	19	215	352,74	1
125316	22	245	435,19	1
125318	24	265	506,63	1
125320	27	290	727,91	1
125322	30	320	880,37	1
125324	32	340	972,40	1

Ti





LLAVE DE ESTRELLA ACODADA

Ti



Cód.	Ø mm	L mm	P.V.P. unid. €	
125330	8x10	190	199,92	1
125332	10x12	200	216,88	1
125334	12x14	220	238,21	1
125336	14x17	255	290,89	1
125338	17x19	280	325,50	1
125340	19x22	300	387,36	1
125342	22x24	330	547,89	1
125344	24x27	340	715,39	1
125346	27x30	350	896,92	1
125348	30x32	370	1.078,45	1



LLAVE FIJA DE GOLPE

Ti



Cód.	Ø mm	L mm	P.V.P. unid. €	
125360	17	125	249,62	1
125362	19	125	262,51	1
125364	22	135	275,39	1
125366	24	150	308,18	1
125368	27	175	377,41	1
125370	30	190	472,78	1
125372	32	190	554,50	1
125374	36	200	653,54	1



LLAVE ESTRELLA PLANA DE GOLPE

Ti



Cód.	Ø mm	L mm	P.V.P. unid. €	
125380	17	145	270,25	1
125382	19	145	300,43	1
125384	22	155	324,00	1
125386	24	165	377,41	1
125388	27	175	451,42	1
125390	30	185	514,01	1
125392	32	185	564,44	1
125394	36	205	670,13	1



LLAVE AJUSTABLE

Ti



Cód.	L mm	Ø mm	P.V.P. unid. €	
125400	150	18	721,30	1
125402	200	24	801,92	1
125404	250	30	923,06	1
125406	300	36	1.214,31	1



LLAVE STILLSON

Ti

125418
125420
125422

Cód.	L mm	L"	Ø mm	P.V.P. unid. €	
125410	200	8	25	571,09	1
125412	250	10	30	711,36	1
125414	300	12	40	905,04	1
125416	350	14	50	1.178,96	1
125418	450	18	60	1.896,23	1
125420	600	24	75	2.525,83	1
125422	900	36	85	4.151,03	1



LLAVE DINAMOMÉTRICA

Ti



Cód.	■"	Capacidad Nm	P.V.P. unid. €	
125426	1/4	2-10	9.525,22	1
125428	3/8	5-50	10.179,49	1
125430	1/2	10-100	12.696,11	1
125432	1/2	20-200	14.875,84	1
125434	1/2	60-300	17.428,54	1
125436	3/4	150-750	19.466,87	1
125438	1	200-1000	23.339,94	1



LLAVE ALLEN

Ti

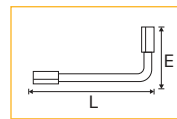

Cód.	● mm	L mm	E mm	P.V.P. unid. €	
125450	3	59	25	74,74	1
125452	4	65	30	80,29	1
125454	5	79	32	89,83	1
125456	6	85	37	109,36	1
125458	7	88	43	125,91	1
125460	8	92	44	142,87	1
125462	9	97	44	159,06	1
125464	10	110	45	181,53	1

Cód.	● mm	L mm	E mm	P.V.P. unid. €	
125466	11	119	48	205,83	1
125468	12	130	52	229,03	1
125470	13	140	54	251,87	1
125472	14	150	58	286,44	1
125474	15	156	60	325,10	1
125476	16	162	63	366,36	1
125478	17	168	65	410,89	1



LLAVE ALLEN MANGO EN T

Ti

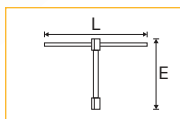

Cód.	● mm	L mm	E mm	P.V.P. unid. €	
125490	8	100	150	177,82	1
125492	10	110	150	187,77	1
125494	12	130	170	192,21	1
125496	14	140	170	200,29	1
125498	17	150	190	216,51	1
125500	19	160	220	245,22	1



LLAVE ALLEN BOLA

Ti

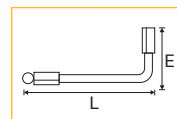

Cód.	● mm	L mm	E mm	P.V.P. unid. €	
125510	3	63	20	101,98	1
125512	4	70	25	114,13	1
125514	5	80	28	129,99	1
125516	6	90	32	142,87	1
125518	7	95	34	159,06	1
125520	8	100	36	177,45	1
125522	9	106	38	199,92	1
125524	10	112	40	224,59	1
125526	11	118	42	249,99	1
125528	12	125	45	286,44	1



DESTORNILLADOR BOCA PLANA

Ti



Cód.	⌀ mm	⊘ mm	↔ mm	P.V.P. unid. €	
125540	3,0	0,5	50	77,68	1
125542	4,0	0,8	75	88,73	1
125544	5,0	1,0	100	101,61	1
125546	6,0	1,1	150	138,06	1
125548	8,0	1,2	200	163,47	1



DESTORNILLADOR BOCA PHILLIPS

Ti



Cód.	⊕	↔ mm	P.V.P. unid. €	
125560	PH0	50	74,37	1
125562	PH1	75	82,49	1
125564	PH1	100	94,27	1
125566	PH2	150	125,91	1
125568	PH3	200	154,66	1



LLAVE DE VASO DE 1/4"

Cód.	Ø mm	L mm	P.V.P. unid. €	
125580	4	25	164,20	1
125581	5	25	168,28	1
125582	6	25	173,05	1
125583	7	25	177,45	1
125584	8	25	183,36	1
125585	9	25	191,85	1
125586	10	25	196,25	1
125587	11	25	205,10	1

Cód.	Ø mm	L mm	P.V.P. unid. €	
125588	12	26	208,77	1
125589	13	26	217,98	1
125590	14	26	229,03	1
125591	15	27	237,47	1
125592	16	27	250,72	1
125593	17	27	261,77	1
125594	18	27	270,25	1
125595	19	27	278,37	1

Ti



LLAVE DE VASO DE 1/2"

Cód.	Ø mm	L mm	P.V.P. unid. €	
125602	6	40	192,21	1
125604	8	40	206,20	1
125606	10	40	229,03	1
125608	12	40	234,90	1

Cód.	Ø mm	L mm	P.V.P. unid. €	
125610	14	40	249,62	1
125612	17	40	262,14	1
125614	19	42	278,37	1
125616	22	43	289,75	1

Ti



LLAVE DE VASO DE 3/4"

Cód.	Ø mm	L mm	P.V.P. unid. €	
125630	17	50	410,15	1
125632	19	50	430,78	1
125634	21	55	456,92	1
125636	22	55	472,01	1
125638	23	55	484,53	1
125640	24	55	511,80	1
125642	26	55	600,16	1
125644	27	55	634,41	1

Cód.	Ø mm	L mm	P.V.P. unid. €	
125646	28	55	666,06	1
125648	29	55	713,56	1
125650	30	60	754,05	1
125652	31	60	801,92	1
125654	32	60	851,62	1
125658	34	60	983,45	1
125662	36	60	1.053,78	1

Ti



LLAVE DE VASO DE IMPACTO 3/4"

Cód.	Ø mm	L mm	P.V.P. unid. €	
125666	17	50	377,41	1
125668	19	50	393,97	1
125670	22	50	412,03	1
125672	24	50	447,34	1

Cód.	Ø mm	L mm	P.V.P. unid. €	
125674	27	50	550,46	1
125676	30	50	658,72	1
125678	32	50	733,46	1

Ti



LLAVE DE CARRACA

Ti



Cód.	■"	L mm	P.V.P. unid. €	
125686	3/8	200	943,32	1
125688	1/2	245	1.294,56	1
125690	3/4	320	1.793,11	1



ALARGADERA

Ti



Cód.	■"	L mm	P.V.P. unid. €	
125700	3/8	75	188,50	1
125702	1/2	125	274,29	1
125704	1/2	250	377,41	1
125706	3/4	200	472,78	1



MANGO ARTICULADO

Ti



Cód.	■"	L mm	P.V.P. unid. €	
125710	3/8	190	307,07	1
125712	1/2	250	422,67	1



JUNIA UNIVERSAL

Ti



Cód.	■"	L mm	P.V.P. unid. €	
125730	1/2	80	423,45	1
125732	3/4	110	921,59	1



MARILO BOLA MANGO MADERA

Ti



Cód.		L mm	P.V.P. unid. €	
125770	230	300	327,71	1
125772	340	325	476,45	1
125774	450	365	642,49	1
125776	680	400	930,07	1



ESPÁTULA, MANGO MADERA

Ti

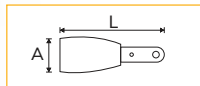

Cód.	A mm	L mm	P.V.P. unid. €	
125800	75	200	308,54	1
125802	100	200	381,81	1
125804	150	250	538,31	1



BARRA DESECOFRAR

Ti

Cód.	L mm	BxA mm	P.V.P. unid. €	
125820	500	15x15	341,69	1
125822	600	18x18	604,57	1
125824	800	20x20	1.047,50	1

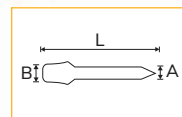

BERBIQUI

Ti



Cód.	■"	L mm	P.V.P. unid. €	
125720	3/8	300	567,01	1
125722	1/2	390	659,08	1



ADAPTADOR

Ti



Cód.	Hembra	Macho	P.V.P. unid. €	
125740	3/8"	1/4"	222,39	1
125742	1/4"	3/8"	229,03	1
125744	1/2"	3/8"	300,06	1
125746	3/8"	1/2"	319,59	1
125748	3/4"	1/2"	447,34	1
125750	1/2"	3/4"	374,84	1



CINCEL

Ti

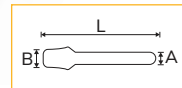

Cód.	L mm	BxA mm	P.V.P. unid. €	
125780	120	10x10	82,49	1
125782	140	12x12	90,19	1
125784	160	14x14	123,34	1
125786	160	16x16	135,13	1
125788	160	18x18	158,70	1
125790	200	20x20	234,54	1
125792	200	22x22	290,89	1



LIMA PLANA, MANGO BIMATERIAL

Ti



Cód.	L mm	L"	P.V.P. unid. €	
125810	200	8	296,39	1
125812	300	12	375,21	1
125814	350	14	447,34	1

18

HERRAMIENTA INOXIDABLE

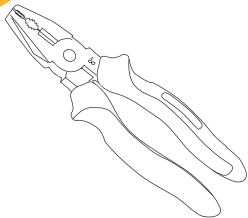

Alicata universal INOX **403**

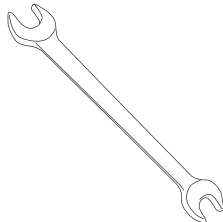

Llave fija INOX **404**



Llave fija de golpe INOX **406**



Llave fija de gancho INOX **407**

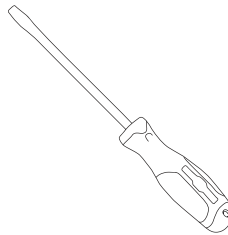

Destornillador INOX **408**

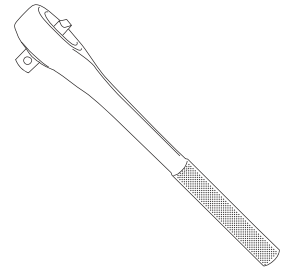

Llave de carraca INOX **409**

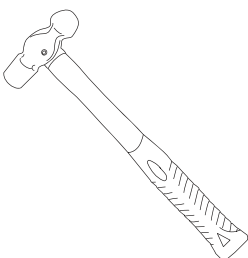

Martillo de bola INOX **411**

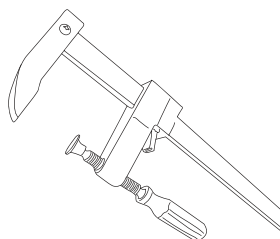

Tornillo de apriete INOX **413**

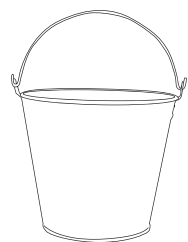

Balde INOX **414**

HERRAMIENTAS DE ACERO INOXIDABLE



**INOX
420**

Acero Inoxidable 420.

La gama de herramienta INOXIDABLE de Alyco está fabricada en Acero Inoxidable 420. Se trata de un tipo de acero martensítico, acero inoxidable altamente aleado con cromo, hierro y otros metales, ferromagnético, ideal para aplicaciones que no requieren cargas extremas y en las que la resistencia a la corrosión es importante.

El Acero Inoxidable 420 es el que presenta la mejor relación dureza/resistencia a la oxidación, frente a otros como los Aceros Inoxidables 304 y 316 que, teniendo mayor resistencia a la oxidación, no cuentan con la dureza necesaria para utilizarlos en la fabricación de herramientas manuales. Es por lo que todas nuestras herramientas INOXIDABLES han sido fabricadas en Acero Inoxidable 420.

Principales VENTAJAS y USOS de las herramientas Inoxidables



ENORMEMENTE RESISTENTES AL DESGASTE

Alcanzan un grado de dureza de 40-45 HRC. Son adecuadas para su uso en la industria aeroespacial, industria química y petroquímica, en automoción, en plantas nucleares, etc.



BASTANTE RESISTENTES A LA CORROSIÓN

Idóneas frente a la corrosión atmosférica, vapor de agua, amoníaco, derivados de petróleo y ambientes ácidos. Son adecuadas para el sector naval, aplicaciones marítimas, etc.



RESPECTUOSAS CON EL MEDIO AMBIENTE, YA QUE EN SU FABRICACIÓN NO SE EMPLEAN CROMADOS U OTROS REVESTIMIENTOS NOCIVOS

En los últimos años, las herramientas manuales de acero inoxidable son cada vez más utilizadas debido a las estrictas medidas medioambientales que se están implantando a nivel mundial. Son adecuadas para el uso en la industria farmacéutica, en medicina, en laboratorios, así como en la industria alimentaria.





ALICATE UNIVERSAL

INOX 420



Cód.	L mm	L"	P.V.P. unid. €	
126100	150	6	79,14	1
126102	175	7	95,74	1
126104	200	8	106,79	1
126106	250	10	133,29	1



ALICATE UNIVERSAL AJUSTABLE

INOX 420



Cód.	L mm	L"	P.V.P. unid. €	
126110	150	6	80,29	1
126112	200	8	95,37	1



ALICATE BOCAS SEMIREDONDAS CON CORTE

INOX 420



Cód.	L mm	L"	P.V.P. unid. €	
126116	150	6	86,89	1
126118	200	8	95,74	1



ALICATE CORTE DIAGONAL

INOX 420



Cód.	L mm	L"	P.V.P. unid. €	
126120	150	6	87,26	1
126122	200	8	95,74	1



TENAZA PICO DE LORO

INOX 420



Cód.	L mm	L"	P.V.P. unid. €	
126126	250	10	122,98	1



TENAZA GRIP BOCAS CURVAS

INOX 420



AM: Apertura Máxima

Cód.	L mm	L"	AM mm	P.V.P. unid. €	
126130	225	9	40	156,49	1



PINZA DE PRECISIÓN

INOX 420



Cód.	L mm	L"	P.V.P. unid. €	
126134	100	4	23,20	1
126136	140	6	32,78	1
126138	180	7	44,57	1
126140	250	10	60,02	1
126142	300	12	69,24	1



PINZA DE PRECISIÓN BOCA CURVA

INOX 420



Cód.	L mm	L"	P.V.P. unid. €	
126146	150	6	37,92	1
126148	200	8	60,02	1



PINZA FORCEPS

INOX 420



Cód.	L mm	L"	P.V.P. unid. €	
126150	120	5	118,21	1
126152	160	6,5	138,80	1
126154	200	8	160,53	1



CUCHILLO

INOX 420



Cód.	L mm	L"	P.V.P. unid. €	
126160	190	8	57,08	1
126162	250	10	69,24	1



LLAVE FIJA DOS BOCAS

INOX 420



Cód.	Ø mm	L mm	P.V.P. unid. €		Cód.	Ø mm	L mm	P.V.P. unid. €	
126170	6x7	92	13,99	1	126186	20x22	190	48,97	1
126172	7x9	96	14,72	1	126188	21x23	205	52,27	1
126174	8x10	100	15,09	1	126190	24x27	230	82,12	1
126176	10x11	110	17,29	1	126192	25x28	236	87,26	1
126178	12x13	120	22,10	1	126194	30x32	265	122,24	1
126180	14x15	140	29,07	1	126196	36x41	330	164,57	1
126182	16x17	150	29,81	1	126198	41x46	360	215,78	1
126184	18x19	170	43,47	1					



LLAVE COMBINADA

INOX
420

Cód.	Ø mm	L mm	P.V.P. unid. €		Cód.	Ø mm	L mm	P.V.P. unid. €	
126210	6	105	20,63	1	126244	23	265	64,79	1
126212	7	120	22,47	1	126246	24	265	69,24	1
126214	8	120	25,40	1	126248	25	265	78,04	1
126216	9	135	29,07	1	126250	26	290	86,89	1
126218	10	135	31,31	1	126252	27	290	99,41	1
126220	11	150	33,52	1	126254	30	320	120,77	1
126222	12	150	36,82	1	126256	32	340	133,29	1
126224	13	175	37,55	1	126258	34	360	155,39	1
126226	14	175	40,49	1	126260	36	360	183,73	1
126228	15	195	41,59	1	126262	38	430	198,08	1
126230	16	195	44,57	1	126264	41	430	233,80	1
126232	17	195	45,67	1	126266	46	480	272,46	1
126234	18	215	47,14	1	126268	50	520	289,42	1
126236	19	215	48,24	1	126270	55	560	318,86	1
126238	20	215	52,27	1	126272	60	595	344,99	1
126240	21	245	56,72	1	126274	65	595	378,14	1
126242	22	245	60,02	1					



LLAVE DE ESTRELLA ACODADA

INOX
420

Cód.	Ø mm	L mm	P.V.P. unid. €		Cód.	Ø mm	L mm	P.V.P. unid. €	
126280	6x7	115	14,35	1	126296	19x22	280	44,57	1
126282	7x9	130	16,19	1	126298	21x23	285	52,27	1
126284	8x10	130	17,29	1	126300	24x27	340	83,22	1
126286	10x11	140	18,80	1	126302	25x28	350	87,99	1
126288	12x13	160	23,93	1	126304	30x32	380	125,55	1
126290	14x17	220	29,44	1	126306	32x36	405	164,20	1
126292	16x18	220	35,72	1	126308	36x41	445	231,60	1
126294	18x19	250	41,22	1					

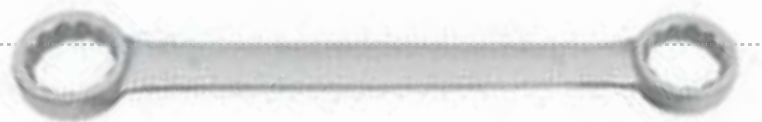

LLAVE DE ESTRELLA PLANA

INOX
420

Cód.	Ø mm	L mm	P.V.P. unid. €		Cód.	Ø mm	L mm	P.V.P. unid. €	
126320	8x10	115	17,29	1	126332	22x24	220	72,54	1
126322	9x11	125	18,02	1	126334	24x27	255	79,14	1
126324	10x12	140	23,20	1	126336	27x30	280	98,67	1
126326	14x17	165	30,54	1	126338	30x32	295	121,88	1
126328	17x19	185	36,82	1	126340	36x41	365	171,95	1
126330	19x22	200	55,98	1					



LLAVE FIJA DE GOLPE

INOX 420



Cód.	Ø mm	L mm	P.V.P. unid. €		Cód.	Ø mm	L mm	P.V.P. unid. €	
126350	17	125	36,82	1	126364	36	210	95,37	1
126352	19	125	37,92	1	126366	41	230	118,57	1
126354	22	135	40,49	1	126368	46	250	141,00	1
126356	24	150	44,93	1	126370	50	275	160,53	1
126358	27	175	55,98	1	126372	55	305	187,40	1
126360	30	190	68,50	1	126374	60	315	223,85	1
126362	32	190	80,65	1	126376	65	335	268,79	1



LLAVE ESTRELLA PLANA DE GOLPE

INOX 420



Cód.	Ø mm	L mm	P.V.P. unid. €		Cód.	Ø mm	L mm	P.V.P. unid. €	
126380	17	145	36,82	1	126400	41	225	137,33	1
126382	19	145	41,22	1	126402	46	235	152,78	1
126384	22	155	44,57	1	126404	50	250	177,08	1
126386	24	165	52,27	1	126406	55	265	211,34	1
126388	27	175	63,69	1	126408	60	274	227,20	1
126390	30	185	71,80	1	126410	65	298	245,59	1
126392	32	185	79,14	1	126412	70	320	269,89	1
126394	34	200	86,89	1	126414	75	326	307,44	1
126396	36	205	92,44	1	126416	80	350	346,10	1
126398	38	215	110,09	1					



LLAVE AJUSTABLE

INOX 420



Cód.	L mm	L"	C mm	P.V.P. unid. €		Cód.	L mm	L"	C mm	P.V.P. unid. €	
126420	100	4	13	52,64	1	126424	300	12	36	146,54	1
126421	150	6	18	67,77	1	126425	375	15	46	226,06	1
126422	200	8	24	91,29	1	126426	450	18	55	284,24	1
126423	250	10	30	114,13	1	126427	600	24	65	504,42	1



LLAVE DE GANCHO FIJA

INOX
420

Cód.	∅ mm	L mm	P.V.P. unid. €	
126430	30-32	136	45,30	1
126431	34-36	170	57,08	1
126432	40-42	170	68,87	1
126433	45-50	206	80,29	1
126434	52-55	206	90,93	1
126435	58-62	242	98,67	1
126436	68-75	242	103,81	1
126437	80-90	280	118,57	1
126438	95-100	280	133,29	1
126439	110-115	334	146,54	1
126440	120-130	334	162,00	1
126441	135-145	383	191,48	1



LLAVE DE GANCHO ARTICULADA

INOX
420

Cód.	∅ mm	L mm	P.V.P. unid. €	
126450	20-35	165	83,22	1
126451	35-60	190	98,67	1
126452	60-90	280	146,54	1
126453	90-155	330	238,94	1
126454	155-230	400	380,71	1



LLAVE ALLEN

INOX
420

Cód.	∅ mm	L mm	P.V.P. unid. €		Cód.	∅ mm	L mm	P.V.P. unid. €		Cód.	∅ mm	L mm	P.V.P. unid. €	
126460	1.5	59	22,10	1	126468	8	92	31,68	1	126476	16	162	70,34	1
126461	2	59	24,30	1	126469	9	97	35,72	1	126477	17	168	72,91	1
126462	2.5	59	25,04	1	126470	10	110	37,55	1	126478	18	173	78,04	1
126463	3	59	25,40	1	126471	11	119	40,49	1	126479	19	177	83,22	1
126464	4	65	25,77	1	126472	12	130	45,67	1	126480	21	184	89,83	1
126465	5	79	26,50	1	126473	13	140	50,81	1	126481	22	186	96,11	1
126466	6	85	27,60	1	126474	14	150	61,12	1					
126467	7	88	30,17	1	126475	15	156	62,96	1					

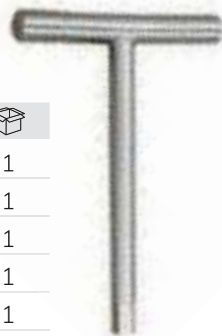

MANGO EN T HEXAGONAL

INOX
420

Cód.	∅ mm	P.V.P. unid. €	
126490	1.5	49,34	1
126491	2	51,17	1
126492	2.5	52,27	1
126493	3	53,01	1
126494	4	55,98	1
126495	5	57,08	1
126496	6	61,12	1
126497	8	66,99	1
126498	10	71,44	1

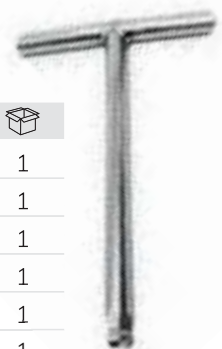

MANGO EN T ALLEN BOLA

INOX
420

Cód.	∅ mm	P.V.P. unid. €	
126500	3	22,47	1
126501	4	25,04	1
126502	5	26,50	1
126503	6	30,54	1
126504	7	34,25	1
126505	8	38,29	1
126506	9	44,57	1
126507	10	48,24	1



DESTORNILLADOR BOCA PLANA

INOX 420

Cód.	Ø mm	mm	mm	P.V.P. unid. €	
126510	3,0	0,6	75	14,72	1
126512	4,0	0,8	100	18,43	1
126514	5,0	1,0	100	19,90	1
126516	6,0	1,1	125	21,73	1
126518	7,0	1,2	150	25,77	1
126520	8,0	1,2	200	30,17	1
126522	9,0	1,6	250	40,49	1
126524	10,0	1,6	300	48,97	1
126526	11,0	1,8	350	63,69	1
126528	12,0	2,0	400	71,44	1



DESTORNILLADOR BOCA PHILLIPS

INOX 420

Cód.	+	mm	P.V.P. unid. €	
126530	PH0	50	14,72	1
126532	PH1	100	19,90	1
126534	PH2	150	25,77	1
126536	PH3	200	30,54	1
126538	PH4	300	49,34	1



DESTORNILLADOR BOCA PLANA, SERIE CORTA

INOX 420

Cód.	Ø mm	mm	P.V.P. unid. €	
126540	3,0	38	22,47	1
126542	4,0	38	25,04	1
126544	5,0	38	26,50	1
126546	6,0	38	29,07	1
126548	8,0	38	29,07	1





LLAVE DE VASO DE 1/2"

INOX
420

Cód.	Ø mm	L mm	P.V.P. unid. €		Cód.	Ø mm	L mm	P.V.P. unid. €	
126560	6	40	25,04	1	126573	19	42	48,24	1
126561	7	40	26,14	1	126574	20	42	50,81	1
126562	8	40	27,60	1	126575	21	43	52,27	1
126563	9	40	29,44	1	126576	22	43	52,27	1
126564	10	40	30,54	1	126577	23	43	57,08	1
126565	11	40	32,78	1	126578	24	43	61,12	1
126566	12	40	35,35	1	126579	25	43	67,77	1
126567	13	40	37,19	1	126580	26	43	71,44	1
126568	14	40	40,49	1	126581	27	46	75,47	1
126569	15	40	41,59	1	126582	28	46	80,29	1
126570	16	40	44,57	1	126583	29	46	85,79	1
126571	17	40	44,93	1	126584	30	46	90,93	1
126572	18	42	46,03	1	126585	32	46	99,78	1



LLAVE DE VASO DE 3/4"

INOX
420

Cód.	Ø mm	L mm	P.V.P. unid. €		Cód.	Ø mm	L mm	P.V.P. unid. €	
126590	17	50	55,98	1	126598	30	60	102,34	1
126591	19	50	56,35	1	126599	32	60	114,13	1
126592	21	55	61,12	1	126600	34	60	125,55	1
126593	22	55	62,59	1	126601	36	60	133,29	1
126594	24	55	70,34	1	126602	38	60	141,00	1
126595	26	55	80,65	1	126603	41	65	155,76	1
126596	27	55	86,89	1	126604	46	65	183,73	1
126597	29	55	96,11	1	126605	50	70	201,75	1



LLAVE DE CARRACA

INOX
420

Cód.	■ "	L mm	P.V.P. unid. €	
126610	1/2	245	133,66	1
126612	3/4	320	268,79	1



MANGO ACODADO

INOX
420

Cód.	■ "	L mm	P.V.P. unid. €	
126616	1/2	230	69,24	1
126618	3/4	280	125,55	1



BERBIQUÍ

INOX 420



Cód.	■"	L mm	P.V.P. unid. €	
126620	1/2	390	99,41	1



LLAVE DE VASO ARTICULADA

INOX 420



Cód.	○ mm	L mm	P.V.P. unid. €	
126630	8x9	200	45,63	1
126632	10x11	210	48,56	1
126634	12x13	230	58,51	1
126636	14x15	240	67,36	1
126638	16x17	250	89,05	1
126640	18x19	270	115,96	1
126642	20x22	290	130,68	1
126644	21x23	290	133,25	1
126646	24x27	330	194,37	1



JUNTA UNIVERSAL

INOX 420



Cód.	■"	L mm	P.V.P. unid. €	
126650	1/2	80	55,98	1
126652	3/4	110	134,39	1



MANGO EN T

INOX 420



Cód.	■"	L mm	P.V.P. unid. €	
126656	1/2	250	93,54	1
126658	3/4	400	171,95	1



JUEGO DE LLAVES DE VASO DE 1/2"

INOX 420

COMPOSICIÓN

- 10 vasos 1/2": 8, 10, 11, 12, 14, 17, 19, 22, 24 y 27 mm.
- 1 llave de carraca 1/2" de 245 mm.
- 1 mango articulado 1/2" de 250 mm.



Cód.	Nº Piezas	P.V.P. unid. €	
126665	12	790,50	1



JUEGO DE LLAVES DE VASO DE 1/2"

INOX 420

COMPOSICIÓN

- 18 vasos 1/2": 10, 11, 12, 13, 14, 15, 16, 17, 18, 19, 20, 21, 22, 23, 24, 27, 30 y 32 mm.
- 1 llave de carraca 1/2" de 245 mm.
- 1 mango en T 1/2".
- 1 junta universal de 1/2".
- 2 alargaderas 1/2" de 125 y 250 mm.
- 1 berbiquí 1/2".



Cód.	Nº Piezas	P.V.P. unid. €	
126670	24	1.676,04	1



**MARTILLO BOLA,
MANGO FIBRA DE VIDRIO**
INOX
420

Cód.	grs.	L mm	P.V.P. unid. €	
126680	230	280	26,50	1
126682	340	280	38,65	1
126684	450	310	50,81	1
126686	680	340	76,57	1
126688	910	350	103,45	1
126690	1130	400	125,18	1



**MARTILLO DE AJUSTADOR,
MANGO FIBRA DE VIDRIO**
INOX
420

Cód.	grs.	L mm	P.V.P. unid. €	
126700	500	310	57,08	1
126702	1000	340	106,42	1
126704	1500	400	160,53	1
126706	2000	400	207,67	1



**MARTILLO DE CARPINTERO,
MANGO FIBRA DE VIDRIO**
INOX
420

Cód.	grs.	L mm	P.V.P. unid. €	
126710	230	280	31,68	1
126712	450	300	49,70	1
126714	680	330	71,44	1



**MACETA OCTOGONAL,
MANGO FIBRA DE VIDRIO**
INOX
420

Cód.	grs.	L mm	P.V.P. unid. €	
126720	450	310	44,57	1
126722	1000	400	93,17	1
126724	1400	400	129,62	1
126726	1500	400	137,33	1
126728	1800	400	164,20	1
126730	2000	400	181,16	1
126732	2200	400	199,18	1
126734	2500	700	224,59	1
126736	2700	700	240,82	1

**MACETA MODELO ALEMAN,
MANGO FIBRA DE VIDRIO**
INOX
420

Cód.	grs.	L mm	P.V.P. unid. €	
126740	500	310	57,45	1
126742	1000	400	110,09	1
126744	1500	400	155,76	1
126746	2000	400	209,50	1

**MACETA CUADRADA,
MANGO FIBRA DE VIDRIO**
INOX
420

Cód.	grs.	L mm	P.V.P. unid. €	
126750	900	340	102,34	1
126752	1800	400	199,18	1



MARTILLO DE BOCAS DE NYLON

INOX 420



Cód.		P.V.P. unid. €	
126760	150	67,77	1
126762	250	94,64	1
126764	350	118,94	1
126766	500	153,15	1
126768	800	199,18	1
126770	1000	258,47	1



CINCEL

INOX 420

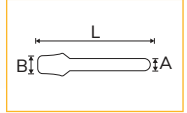

Cód.	L mm	∅ mm	B mm	P.V.P. unid. €	
126780	160	16	16	27,60	1
126782	200	18	18	40,86	1
126784	250	24	24	84,32	1
126786	300	24	24	106,42	1
126788	400	25	25	153,92	1
126790	500	25	25	195,15	1



CUÑA

Cód.	LxA mm	H mm	P.V.P. unid. €	
126800	80x13	(6-0)	5,14	1
126802	100x50	(10-0)	20,27	1
126804	135x50	(18-0)	49,34	1
126806	150x25	(8-0)	12,88	1
126808	150x25	(13-0)	21,73	1
126810	150x40	(8-0)	21,37	1
126812	150x50	(13-0)	40,86	1
126814	180x32	(13-0)	30,17	1
126816	180x50	(19-0)	69,24	1
126818	200x20	(30-0)	49,34	1
126820	200x30	(30-0)	74,37	1
126822	200x40	(40-0)	129,62	1
126824	200x50	(12-0)	51,17	1
126826	230x40	(20-0)	75,47	1
126828	250x40	(30-0)	122,98	1
126830	300x50	(40-0)	241,92	1

INOX 420

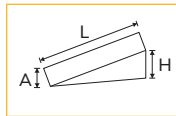

ARCO DE SIERRA

INOX 420



Cód.	L mm	P.V.P. unid. €	
126840	500	117,84	1



PALANCA

INOX 420



Cód.	L mm	P.V.P. unid. €	
126850	450	145,08	1
126852	600	254,80	1
126854	750	372,97	1
126856	900	415,70	1



BARRA DE DESENCOFRAR

INOX 420

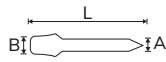

Cód.	L mm	∅ mm	B mm	P.V.P. unid. €	
126860	500	22	22	164,20	1
126862	600	25	25	224,95	1
126864	800	25	25	253,33	1
126866	1000	30	30	544,18	1



TORNILLO DE APRIETE

INOX 420

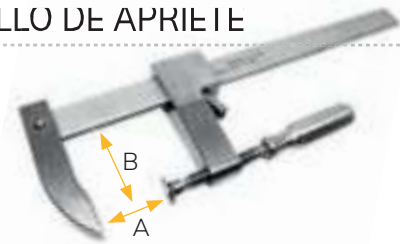

Cód.	A mm	B mm	P.V.P. unid. €	
126870	150	50	107,89	1
126872	200	50	110,46	1
126874	250	80	173,05	1
126876	300	80	195,15	1
126878	400	80	212,07	1
126880	500	80	226,06	1
126882	600	120	416,07	1
126884	800	120	479,02	1



ESPÁTULA, MANGO BIMATERIAL

INOX 420



Cód.	A mm	L mm	P.V.P. unid. €	
126890	25	200	29,07	1
126892	40	200	35,72	1
126894	50	200	44,57	1
126896	65	200	53,37	1



LLAVE STILLSON

INOX 420



Cód.	L mm	L"	P.V.P. unid. €	
126900	250	10	121,88	1
126902	300	12	153,92	1
126904	350	14	187,40	1
126906	450	18	285,71	1
126908	600	24	431,15	1
126910	900	36	802,28	1



PALA PUNTA MANGO MADERA

INOX 420

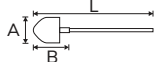

Cód.	BxA mm	L mm	P.V.P. unid. €	
126920	420x240	1450	241,55	1



PALA CUADRADA MANGO MADERA

INOX 420

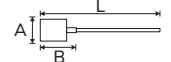

Cód.	BxA mm	L mm	P.V.P. unid. €	
126925	418x240	1450	242,65	1



TORNILLO DE BANCO

INOX 420

Cód.	L mm	Kgs	P.V.P. unid. €	
126930	75	6,2	2.711,76	1
126932	100	7,0	3.194,45	1
126934	150	19,5	5.826,71	1
126936	200	29,5	8.147,07	1
126938	250	44,5	11.144,91	1



BALDE

INOX 420

- Cod. 126940: Cuerpo cilíndrico.
- Cod. 126942 / 126944: Cuerpo cónico.

Cód.	L	L mm	P.V.P. unid. €	
126940	15	280	318,86	1
126942	10	250	202,12	1
126944	15	280	262,14	1



126940
Incluye tapa



126942
126944



EMBUDO

INOX 420



Cód.	∅ mm	L mm	P.V.P. unid. €	
126950	160	130	42,69	1
126952	160	150	43,83	1



BIDÓN JERRYCAN

INOX 420



Cód.	L	L mm	P.V.P. unid. €	
126956	10	300	291,99	1



CAZO PARA ACEITE

INOX 420



Cód.	∅ mm	L mm	P.V.P. unid. €	
126958	85	350	35,72	1



BOMBA DE ACEITE PORTÁTIL

INOX 420



Cód.	∅ mm	L mm	P.V.P. unid. €	
126960	165	1100	358,61	1

19

EXPOSITORES

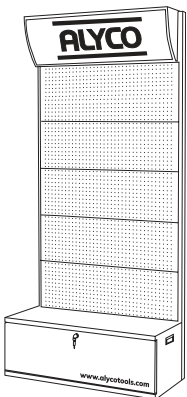

Expositor clásico

416

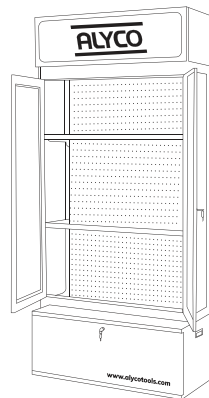

Expositor de vitrina

416

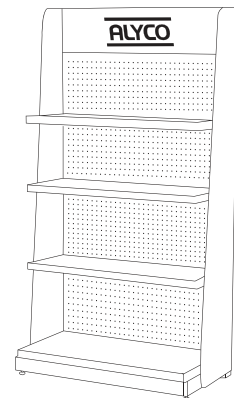

Góndola

417

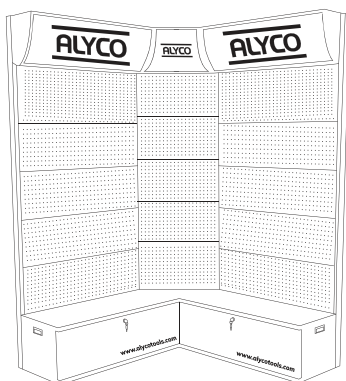

Expositor esquinero

418

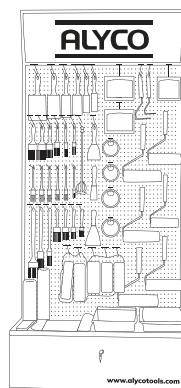

Expositor accesorios de pintura

419

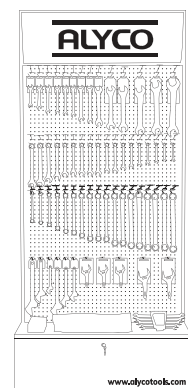

Expositor de llaves

420



EXPOSITOR CLÁSICO

- 30 ganchos incluidos (Cód. 113640).
- Baldas bajo pedido (Cod. 113636). No se incluyen en el expositor (Cód. 113503).
- Planos disponibles.



Incluye fluorescente para el cabezal.



Cajón inferior de carga con cerradura.



1000x450x2200 mm
(ancho x profundo x alto).



Cód.	Modelo	P.V.P. unid. €	
113503	EXPOSITOR	715,53	1
113636	BALDA	46,88	1
113640	GANCHO PORTAPRECIOS	2,19	1



EXPOSITOR DE VITRINA

- 30 ganchos incluidos (Cód. 113640).
- Baldas bajo pedido (Cód. 113636). No se incluyen en el expositor (Cód. 113626).
- Incluye cerradura con 2 llaves.
- Planos disponibles.



1000x500x2200 mm
(ancho x profundo x alto).



Cód.	Modelo	P.V.P. unid. €	
113626	EXPOSITOR	1.154,00	1
113636	BALDA	46,88	1
113640	GANCHO PORTAPRECIOS	2,19	1



GÓNDOLA SIMPLE

- Baldas (Cód. 113631) y ganchos (113640) disponibles bajo pedido. No se incluyen en el expositor (Cód. 113630).
- Incluye 4 patas niveladoras.
- Planos disponibles.



840x450x1600 mm
(ancho x profundo x alto).

Cód.	Modelo	P.V.P. unid. €	
113630	EXPOSITOR	429,80	1
113631	BALDA	44,40	1
113640	GANCHO PORTAPRECIOS	2,19	1



GÓNDOLA DOBLE

- Baldas (113636) y ganchos (113640) disponibles bajo pedido. No se incluyen en el expositor (Cód. 113635).
- Incluye 4 patas niveladoras.
- Planos disponibles.



Cód.	Modelo	P.V.P. unid. €	
113635	EXPOSITOR	482,28	1
113636	BALDA	46,88	1
113640	GANCHO PORTAPRECIOS	2,19	1

1000x840x1600 mm
(ancho x profundo x alto).



EXPOSITOR GIRATORIO

- Ganchos bajo pedido (Cód. 113640). No se incluyen en el expositor (Cód. 113645).
- Planos disponibles.



∅ 700x1670 mm
(diámetro x alto).

Cód.	Modelo	P.V.P. unid. €	
113645	EXPOSITOR	701,12	1
113640	GANCHO PORTAPRECIOS	2,19	1



EXPOSITOR ESQUINERO

- Ganchos bajo pedido (Cód. 113640). No se incluyen en el expositor (Cód. 113650).
- Planos disponibles.



636x840x2200 mm
(ancho x profundo x alto).

Cód.	Modelo	P.V.P. unid. €	
113650	EXPOSITOR	408,72	1
113640	GANCHO PORTAPRECIOS	2,19	1



BALDA PARA EXPOSITOR

- Balda cód. 113631 válida para expositor cód. 113630.
- Balda cód. 113636 válida para expositores cód. 113503 113626 / 113635.



No se incluyen con ningún expositor.
Se han de pedir por separado.

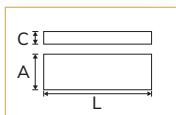

Cód.	A x B x C mm	P.V.P. unid. €	
113631	808x300x30	44,40	1
113636	965x300x30	46,88	1



GANCHO PORTA-PRECIO

- Se suministran 30 unidades con expositores cód. 113503 y 113626. En el resto de casos hay que pedirlos por separado.
- Cada gancho incluye una tarjeta plástica para colocar en la varilla superior y poder identificar el producto.



Cód.	L mm	∅ mm	P.V.P. unid. €	
113640	200	5	2,19	1



EXPOSITOR DE DESTORNILLADORES

COMPOSICIÓN

Cód	Descripción	Unid.	Fila.	Pos.	Cód	Descripción	Unid.	Fila.	Pos.
119008	PLANO 8.0x1.2x150 MM	12	1	1	170423	PHILLIPS PH3x150 MM ORANGE	12	3	1
119006	PLANO 6.5x1.2x150 MM	12	1	2	170422	PHILLIPS PH2x150 MM ORANGE	12	3	2
119007	PLANO 6.5x1.2x109 MM	12	1	3	170419	PHILLIPS PH2x100 MM ORANGE	12	3	3
119005	PLANO 5.5x1.0x125 MM	12	1	4	170421	PHILLIPS PH1x100 MM ORANGE	12	3	4
119024	RECTO 4.0x0.8x100 MM	12	1	5	170420	PHILLIPS PH0x75 MM ORANGE	12	3	5
119023	RECTO 3.0x0.5x100 MM	12	1	6	170429	PHILLIPS PH2x38 MM ORANGE	12	3	6
119004	PLANO 4.0x0.8x80 MM	12	1	7	170428	PHILLIPS PH1x38 MM ORANGE	12	3	7
119022	RECTO 2.5x0.4x75 MM	12	1	8	170433	POZIDRIVE PZ3x150 MM ORANGE	12	3	8
119014	PLANO 6.5x1.2x38 MM	12	1	9	170432	POZIDRIVE PZ2x150 MM ORANGE	12	3	9
119012	PLANO 5.5x1.0x38 MM	12	1	10	170408	PLANO 8.0x1.2x150 MM ORANGE	12	3	10
119098	TORX INVOLUBLE T45x125 MM	12	1	11	170406	PLANO 6.5x1.2x150 MM ORANGE	12	3	11
119097	TORX INVOLUBLE T40x125 MM	12	1	12	170415	RECTO 5.0x0.8x150 MM ORANGE	12	3	12
119096	TORX INVOLUBLE T30x100 MM	12	1	13	170431	POZIDRIVE PZ1x100 MM ORANGE	12	3	13
119095	TORX INVOLUBLE T27x100 MM	12	1	14	170414	RECTO 4.0x0.8x100 MM ORANGE	12	3	14
119094	TORX INVOLUBLE T25x100 MM	12	1	15	170430	POZIDRIVE PZ0x75 MM ORANGE	12	3	15
119093	TORX INVOLUBLE T20x100 MM	12	1	16	170426	PHILLIPS PH1x75 MM ORANGE	12	3	16
119092	TORX INVOLUBLE T15x80 MM	12	1	17	170418	RECTO 6.0x0.8x300 MM ORANGE	12	3	17
119091	TORX INVOLUBLE T10x80 MM	12	1	18	170427	PHILLIPS PH2x300 MM ORANGE	12	3	18
119083	CON VASO HEXAG. 13x150 MM	12	2	1	170392	PHILLIPS PH2x100 MM AISLADO ORANGE	12	4	1
119081	CON VASO HEXAG. 11x150 MM	12	2	2	170391	PHILLIPS PH1x80 MM AISLADO ORANGE	12	4	2
119079	CON VASO HEXAG. 9x150 MM	12	2	3	170384	PLANO 4.0x100 MM AISLADO ORANGE	12	4	3
119076	CON VASO HEXAG. 6x150 MM	12	2	4	170396	POZIDRIVE PZ1x80 MM AISLADO ORANGE	12	4	4
119033	PHILLIPS PH3x150 MM	12	2	5	119306	PLANO 6.5x1.2x150 MM AISLADO	12	4	5
119032	PHILLIPS PH2x150 MM	12	2	6	119308	PLANOP 8.0x1.2x150 MM AISLADO	12	4	6
119029	PHILLIPS PH2x100 MM	12	2	7	119305	PLANO 5.5x1.0x125 MM AISLADO	12	4	7
119031	PHILLIPS PH1x100 MM	12	2	8	119303	PLANO 3.0x0.5x100 MM AISLADO	12	4	8
119030	PHILLIPS PH0x75 MM	12	2	9	119304	PLANO 4.0x0.8x100 MM AISLADO	12	4	9
119035	PHILLIPS PH1x38 MM	12	2	10	119302	PLANO 2.5x0.4x80 MM AISLADO	12	4	10
119043	POZIDRIVE PZ3x150 MM	12	2	11	119312	PHILLIPS PH2x100 MM AISLADO	12	4	11
119042	POZIDRIVE PZ2x150 MM	12	2	12	119321	POZIDRIVE PZ1x100 MM AISLADO	12	4	12
119041	POZIDRIVE PZ1x100 MM	12	2	13	119322	POZIDRIVE PZ2x100 MM AISLADO	12	4	13
119040	POZIDRIVE PZ0x75 MM	12	2	14	119311	PHILLIPS PH1x100 MM AISLADO	12	4	14
119036	PHILLIPS PH2x38 MM	12	2	15	119310	PHILLIPS PH0x75 MM AISLADO	12	4	15
119038	PHILLIPS PH1x250 MM	12	2	16	170450	JUEGO 8 DEST. ORANGE	2	5	1
119010	PLANO 10.0x1.6x200 MM	12	2	17	119050	JUEGO 6 DEST. CAJA	2	5	2
119018	RECTO 6.0x1.0x300 MM	12	2	18	119330	JUEGO 6 DEST. AISLADOS CAJA	2	5	3
113503	EXPOSITOR 1000x450x2200 MM	1			119055	JUEGO 8 DEST. CAJA	2	5	4
113640	GANCHO PORTAPRECIOS Ø5 - 200 MM	70			119099	JUEGO 6 DEST. TORX INVOLUBLES	2	5	5

Cód.	Nº piezas	P.V.P. unid. €	
113720	838	4.610,94	1

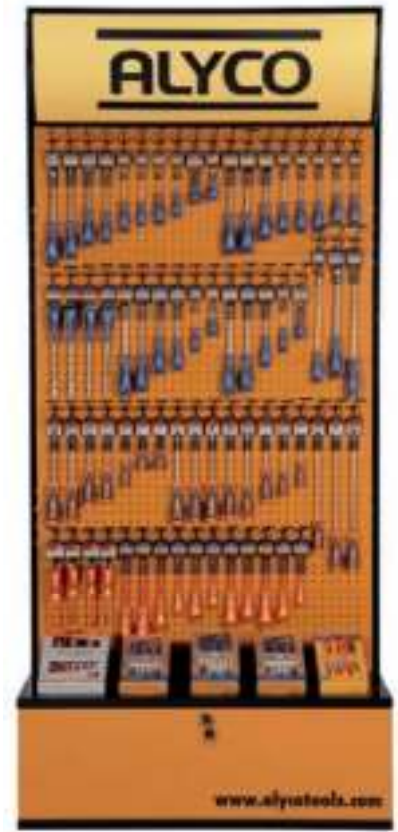

EXPOSITOR DE ACCESORIOS DE PINTURA

COMPOSICIÓN

Cód	Descripción	Unid.	Fila.	Pos.	Cód	Descripción	Unid.	Fila.	Pos.
187039	PALETINA TRIPLE SINTETICA ESP. 100MM	12	1	1	187046	PALETINA RADIADOR 60MM	6	4	1
187037	PALETINA TRIPLE SINTETICA ESP. 75MM	12	1	2	187044	PALETINA RADIADOR 40MM	6	4	2
187036	PALETINA TRIPLE SINTETICA ESP. 63MM	12	1	3	187042	PALETINA RADIADOR 20MM	6	4	3
187035	PALETINA TRIPLE SINTETICA ESP. 50MM	12	1	4	187015	PALETINA DOBLE ESTANDAR 50MM	12	4	4
187034	PALETINA TRIPLE SINTETICA ESP. 38MM	12	1	5	187014	PALETINA DOBLE ESTANDAR 40MM	12	4	5
187032	PALETINA TRIPLE SINTETICA ESP. 25MM	12	1	6	187013	PALETINA DOBLE ESTANDAR 30MM	12	4	6
187104	RECAMBIO MINI-RODILLO 100MM ACRILICO	6	1	7	187012	PALETINA DOBLE ESTANDAR 20MM	12	4	7
187124	MANGO PLASTICO 100MM MINI-RODILLO	6	1	8	196360	ESPÁTULA MANGO MADERA 60 MM	12	4	8
187122	MANGO PLASTICO 50MM MINI-RODILLO	6	1	9	187191	CINTA DE PINTOR 24MM X 50M	12	4	9
187114	RECAMBIO MINI-RODILLO 100MM LANA	6	1	10	187149	RECAMBIO RODILLO 230MM LANA	6	5	1
187026	PALETINA TRIPLE SINTETICA 60MM	12	2	1	187139	RECAMBIO RODILLO 230MM POLIAMIDA	6	5	2
187025	PALETINA TRIPLE SINTETICA 50MM	12	2	2	187157	RECAMBIO RODILLO 180MM ACRILICO	6	5	3
187024	PALETINA TRIPLE SINTETICA 40MM	12	2	3	187137	RECAMBIO RODILLO 180MM POLIAMIDA	6	5	4
187023	PALETINA TRIPLE SINTETICA 30MM	12	2	4	187147	RECAMBIO RODILLO 180MM LANA	6	5	5
187022	PALETINA TRIPLE SINTETICA 25MM	12	2	5	187189	RODILLO 230MM ACRILICO	6	5	6
187020	PALETINA TRIPLE SINTETICA 20MM	12	2	6	187187	RODILLO 180MM ACRILICO	6	5	7
198835	VARILLA MEZCLADORA REFORZADA M14	6	2	7	187092	RECAMBIO MINI-RODILLO 50MM ESPUMA	6	6	1.1
196406	ESPÁTULA INOXIDABLE M/BIMAT. 60 MM	12	2	8	187203	PAPEL PROTECCION C/CINTA 300MM X 20M	12	6	1.2
187192	CINTA DE PINTOR 48MM X 25M	12	2	9	187204	PAPEL PROTECCION C/CINTA 450MM X 20M	12	6	1.3
187094	RECAMBIO MINI-RODILLO 100MM ESPUMA	6	2	10	187102	RECAMBIO MINI-RODILLO 50MM ACRILICO	6	6	2.1
187169	RODILLO 230MM POLIAMIDA	6	2	11	187206	PAPEL PROTECCION C/CINTA 600MM X 20M	12	6	2.2
187167	RODILLO 180MM POLIAMIDA	6	2	12	187200	PLÁSTICO PROTECCION 4X5M - 7 MICRAS	12	6	3.1
187055	BROCHA REDONDA Nº 16	12	3	1	187062	PINCEL Nº 2, MANGO MADERA	12	6	3.2
187054	BROCHA REDONDA Nº 14	12	3	2	187064	PINCEL Nº 4, MANGO MADERA	12	6	3.2
187053	BROCHA REDONDA Nº 12	12	3	3	187066	PINCEL Nº 6, MANGO MADERA	12	6	3.2
187052	BROCHA REDONDA Nº 10	12	3	4	187068	PINCEL Nº 8, MANGO MADERA	12	6	3.2
187051	BROCHA REDONDA Nº 8	12	3	5	187070	PINCEL Nº 10, MANGO MADERA	12	6	3.2
187050	BROCHA REDONDA Nº 6	12	3	6	187072	PINCEL Nº 12, MANGO MADERA	12	6	3.2
196399	ESPÁTULA INOXIDABLE M/BIMAT. 30 MM	12	3	7	187074	PINCEL Nº 14, MANGO MADERA	12	6	3.2
187190	CINTA DE PINTOR 24MM X 25M	12	3	8	187076	PINCEL Nº 16, MANGO MADERA	12	6	3.2
187193	CINTA DE PINTOR 48MM X 50M	12	3	9	187080	PINCEL Nº 20, MANGO MADERA	12	6	3.2
187179	RODILLO 230MM LANA	6	3	10	187112	RECAMBIO MINI-RODILLO 50MM LANA	6	6	4.1
187177	RODILLO 180MM LANA	6	3	11	187235	SET ACCESORIOS DE PINTURA (9 PZAS.)	12	6	5
113503	EXPOSITOR 1000x450x2200 MM	1			187230	SET ACCESORIOS DE PINTURA (12 PZAS.)	12	6	6
113640	GANCHO PORTAPRECIOS Ø5 - 200 MM	50							

Cód.	Nº piezas	P.V.P. unid. €	
113715	666	2.218,56	1





EXPOSITOR DE ACCESORIOS DE FONTANERÍA

COMPOSICIÓN

Cód	Descripción	Unid.	Fila.	Pos.	Cód	Descripción	Unid.	Fila.	Pos.
111324	STILLSON FORJADA 24" 600 MM	1	1	1	111390	LLAVE COMBINADA FORJADA TUBO 3"	1	3	1
111318	STILLSON FORJADA 18" 450 MM	2	1	2	111385	LLAVE COMBINADA FORJADA TUBO 2"	1	3	2
111314	STILLSON FORJADA 14" 350 MM	2	1	3	111365	LLAVE RECTA FORJADA TUBO 2"	1	3	3
111312	STILLSON FORJADA 12" 300 MM	2	1	4	111360	LLAVE RECTA FORJADA TUBO 1-1/2"	2	3	4
111310	STILLSON FORJADA 10" 250 MM	4	1	5	111355	LLAVE RECTA FORJADA TUBO 1"	2	3	5
111308	STILLSON FORJADA 8" 200 MM	14	1	6	111522	CORTATUBOS FORJADO 12-50MM	2	3	6
111410	STILLSON DE ALUMINIO 10' 250 MM	4	1	7	111340	LLAVE CADENA FORJADA 12' 300MM	4	3	7
111412	STILLSON DE ALUMINIO 12' 300 MM	4	1	8	111338	LLAVE FORJADA CORREA 12' 300 MM	4	3	8
111414	STILLSON DE ALUMINIO 14' 350 MM	4	1	9	111330	LLAVE FORJADA CORREA 9' 225 MM	4	3	9
111418	STILLSON DE ALUMINIO 18' 450 MM	2	1	10	111419	STILLSON ACODADA 90° ALUM. 18' 450 MM	2	3	10
111424	STILLSON DE ALUMINIO 24' 600 MM	1	1	11	111425	STILLSON ACODADA 90° ALUM. 24' 600 MM	1	3	11
111505	MINICORTATUBO BR-AL-CU DIAM 3-16 MM	4	2	1	108250	CORTATUBOS PVC 27MM	2	4	1
111506	MINICORTATUBO BR-AL-CU DIAM 3-22 MM	4	2	2	108260	CORTATUBOS PVC 42MM	2	4	2
111507	MINICORTATUBO BR-AL-CU DIAM 3-28 MM	4	2	3	111514	CORTATUBOS TELESCÓPICO 3-45 MM	4	4	3
113503	EXPOSITOR 1000x450x2200 MM	1			111513	CORTATUBOS TELESCÓPICO 3-35 MM	4	4	4
113640	GANCHO PORTAPRECIOS Ø5 - 200 MM	40			111511	CORTATUBOS BR-AL-CU DIAM 15-45 MM	4	4	5
					111510	CORTATUBOS BR-AL-CU DIAM 3-30 MM	4	4	6
					111545	REBARBADOR PLÁSTICO 150 MM	6	4	7
					111436	STILLSON DE ALUMINIO 36' 900 MM	1	5	1



Cód.	Nº Piezas	P.V.P. unid. €	
113740	103	2.674,77	1



EXPOSITOR DE LLAVES

COMPOSICIÓN

Cód	Descripción	Unid.	Fila.	Pos.	Cód	Descripción	Unid.	Fila.	Pos.
191010	LLAVE FIJA 8X9 MM	10	1	1	191105	LLAVE ACODADA 6X7 MM	10	3	1
191015	LLAVE FIJA 10X11 MM	10	1	2	191110	LLAVE ACODADA 8X9 MM	10	3	2
191012	LLAVE FIJA 10X13 MM	10	1	3	191115	LLAVE ACODADA 10X11 MM	10	3	3
191020	LLAVE FIJA 12X13 MM	10	1	4	191120	LLAVE ACODADA 12X13 MM	10	3	4
191025	LLAVE FIJA 14X15 MM	10	1	5	191125	LLAVE ACODADA 14X15 MM	10	3	5
191030	LLAVE FIJA 16X17 MM	10	1	6	191128	LLAVE ACODADA 13X17 MM	10	3	6
191035	LLAVE FIJA 18X19 MM	10	1	7	191130	LLAVE ACODADA 16X17 MM	10	3	7
191040	LLAVE FIJA 20X22 MM	5	1	8	191133	LLAVE ACODADA 17X19 MM	10	3	8
191045	LLAVE FIJA 21X23 MM	5	1	9	191135	LLAVE ACODADA 18X19 MM	10	3	9
191050	LLAVE FIJA 24X26 MM	5	1	10	191138	LLAVE ACODADA 19X22 MM	5	3	10
191060	LLAVE FIJA 27X29 MM	5	1	11	191140	LLAVE ACODADA 20X22 MM	5	3	11
191070	LLAVE FIJA 30X32 MM	5	1	12	191145	LLAVE ACODADA 21X23 MM	5	3	12
191072	LLAVE FIJA 32X36 MM	5	1	13	191148	LLAVE ACODADA 22X24 MM	5	3	13
191075	LLAVE FIJA 36X41 MM	5	1	14	191150	LLAVE ACODADA 24X26 MM	5	3	14
191203	LLAVE COMBINADA 6 MM	10	2	1	191155	LLAVE ACODADA 24X27 MM	5	3	15
191206	LLAVE COMBINADA 7 MM	10	2	2	191160	LLAVE ACODADA 25X28 MM	5	3	16
191209	LLAVE COMBINADA 8 MM	10	2	3	191165	LLAVE ACODADA 27X29 MM	5	3	17
191212	LLAVE COMBINADA 9 MM	10	2	4	191170	LLAVE ACODADA 30X32 MM	5	3	18
191215	LLAVE COMBINADA 10 MM	10	2	5	172273	AJUSTABLE MOLETA LATERAL 300 MM	6	4	1
191218	LLAVE COMBINADA 11 MM	10	2	6	172271	AJUSTABLE MOLETA LATERAL 200 MM	6	4	2
191221	LLAVE COMBINADA 12 MM	10	2	7	172270	AJUSTABLE MOLETA LATERAL 150 MM	6	4	3
191224	LLAVE COMBINADA 13 MM	10	2	8	172253	AJUSTABLE 300 MM	6	4	4
191227	LLAVE COMBINADA 14 MM	5	2	9	172252	AJUSTABLE 250 MM	6	4	5
191230	LLAVE COMBINADA 15 MM	5	2	10	172251	AJUSTABLE 200 MM	6	4	6
191233	LLAVE COMBINADA 16 MM	5	2	11	172286	AJUSTABLE CORTA APERT. EXTRA 140MM	6	4	7
191236	LLAVE COMBINADA 17 MM	5	2	12	172288	AJUSTABLE CORTA APERT. EXTRA 160MM	6	4	8
191239	LLAVE COMBINADA 18 MM	5	2	13	172280	AJUSTABLE APERTURA EXTRA 150 MM	6	4	9
191242	LLAVE COMBINADA 19 MM	5	2	14	172281	AJUSTABLE APERTURA EXTRA 200 MM	6	4	10
191245	LLAVE COMBINADA 20 MM	5	2	15	172282	AJUSTABLE APERTURA EXTRA 250 MM	5	4	11
191248	LLAVE COMBINADA 21 MM	5	2	16	190182	JUEGO 10 LLAVES FIJAS AISLADAS	2	5	1
191251	LLAVE COMBINADA 22 MM	5	2	17	191085	JUEGO 12 LLAVES FIJAS 6X7-30X32 MM	2	5	2
191254	LLAVE COMBINADA 23 MM	5	2	18	191280	JUEGO 8 LLAVES COMBINADAS 8-19 MM	2	5	3
113503	EXPOSITOR 1000x450x2200 MM	1							
113640	GANCHO PORTAPRECIOS Ø5 - 200 MM	65							



Cód.	Nº Piezas	P.V.P. unid. €	
113725	441	5.845,52	1



EXPOSITOR DE ALICATES

COMPOSICIÓN

Cód	Descripción	Unid.	Fila.	Pos.	Cód	Descripción	Unid.	Fila.	Pos.
101203	UNIVERSAL 200 MM	6	1	1	115115	AJUSTE RÁPIDO 6" 150 MM	6	3	1
101202	UNIVERSAL 180 MM	6	1	2	115120	AJUSTE RÁPIDO 7" 180 MM	6	3	2
101201	UNIVERSAL 160 MM	6	1	3	115125	AJUSTE RÁPIDO 9.5" 240 MM	6	3	3
101200	UNIVERSAL 130 MM	6	1	4	115130	AJUSTE RÁPIDO 12" 300 MM	5	3	4
102201	BOCAS PLANAS 160 MM	6	1	5	106202	SEEEGER EXT. BOCA RECTA 140 MM	6	3	5
101300	BOCAS SEMI REDONDAS 140 MM	6	1	6	106203	SEEEGER EXT. BOCA RECTA 180 MM	6	3	6
101301	BOCAS SEMI REDONDAS 160 MM	6	1	7	106206	SEEEGER EXT. BOCA CURVA 140 MM	6	3	7
110310	CORTE DIAGONAL REFORZADO 180 MM	6	1	8	106207	SEEEGER EXT. BOCA CURVA 180 MM	6	3	8
101302	BOCAS SEMI REDONDAS 200 MM	6	1	9	106209	SEEEGER INT. BOCA RECTA 140 MM	6	3	9
101310	BOCAS SEMI REDONDA CURVO 200 MM	6	1	10	106210	SEEEGER INT. BOCA RECTA 180 MM	6	3	10
110311	CORTE DIAGONAL REFORZADO 200 MM	6	1	11	106212	SEEEGER INT. BOCA CURVA 140 MM	6	3	11
107101	PELACABLES 160 MM	6	1	12	106213	SEEEGER INT. BOCA CURVA 180 MM	6	3	12
101801	UNIVERSAL AISLADO 160MM	6	2	1	109101	GRIP BOCAS CURVAS 135 MM	3	4	1
101802	UNIVERSAL AISLADO 180MM	6	2	2	109102	GRIP BOCAS CURVAS 190 MM	3	4	2
101803	UNIVERSAL AISLADO 200MM	5	2	3	109103	GRIP BOCAS CURVAS 235 MM	3	4	3
101821	CORTE DIAGONAL AISLADO 160 MM	6	2	4	110320	CORTE DIAGONAL ARTICULADO 200 MM	5	4	4
101822	CORTE DIAGONAL AISLADO 180 MM	6	2	5	110322	CORTE DIAGONAL ARTICULADO 35° 200MM	5	4	5
101826	CORTE DIAGONAL REFOR. AISLADO 200 MM	6	2	6	114015	TENAZA RUSA 9" 225 MM	6	4	6
101810	PUNTAS SEMI REDONDAS AISLADO 160 MM	6	2	7	114017	TENAZA RUSA 11" 280 MM	6	4	7
101811	PUNTAS SEMI REDONDAS AISLADO 200 MM	6	2	8	108015	TIJERA 145 MM	12	4	8
101815	PUNTAS SEMI RED. CURVO AISLADO 200MM	6	2	9	108215	TIJERA 145 MM + FUNDA	12	4	9
101835	BOCAS PLANAS AISLADO 160 MM	6	2	10	108032	NAVAJA PLEGABLE FILO 65 MM	12	4	10
101830	BOCAS REDONDAS AISLADO 160 MM	6	2	11	101218	JUEGO 4 SEEEGER 140 MM	1	5	1
101845	TENACILLA CANAL AISLADA 240 MM	6	2	12	101210	JUEGO 3 ALICATES	1	5	2
113503	EXPOSITOR 1000x450x2200 MM	1			101860	JUEGO 3 ALICATES AISLADOS	1	5	3
113640	GANCHO PORTAPRECIOS Ø5 - 200 MM	50							



Cód. N° Piezas P.V.P. unid. €

113730 284 **6.304,62** 1

EXPOSITOR DE MARTILLOS

COMPOSICIÓN

Cód	Descripción	Unid.	Fila.	Pos.	Cód	Descripción	Unid.	Fila.	Pos.
196550	BOLA 455 GR. HICKORY	6	1	1	196524	PEÑA 30 MM HICKORY	6	3	1
196555	BOLA 680 GR. HICKORY	6	1	2	196523	PEÑA 25 MM HICKORY	6	3	2
196560	BOLA 910 GR. HICKORY	6	1	3	196520	PEÑA 22 MM HICKORY	6	3	3
196562	BOLA 1360 GR. HICKORY	6	1	4	196515	PEÑA 20 MM HICKORY	6	3	4
186320	BOLA 455 GR. FIBRA VIDRIO	6	1	5	186314	PEÑA 30 MM FIBRA VIDRIO	6	3	5
186324	BOLA 680 GR. FIBRA VIDRIO	6	1	6	186312	PEÑA 25 MM FIBRA VIDRIO	6	3	6
186326	BOLA 910 GR. FIBRA VIDRIO	6	1	7	186310	PEÑA 22 MM FIBRA VIDRIO	6	3	7
196715	NYLON 44 MM MADERA	6	2	1	186308	PEÑA 20 MM FIBRA VIDRIO	6	3	8
196710	NYLON 34 MM MADERA	6	2	2	186302	MACETA CUADRADA 1.5 KG. HICKORY	6	4	1
196725	NYLON 35 MM ANTIRREBOTE	6	2	3	196500	MACETA ALBANIL 1.0 KG. MADERA	6	4	2
196810	NYLON 34 MM METALICO	6	2	4	196600	MACETA ALBANIL 1.0 KG. FIBRA VIDRIO	6	4	3
196575	UÑA CURVA 800 GR. MADERA	6	2	5	196602	MACETA ALBANIL 1.5 KG. FIBRA VIDRIO	6	4	4
196570	UÑA CURVA 600 GR. MADERA	6	2	6	196790	MAZA 690 GR. ANTIRREBOTE	6	4	5
196670	UÑA CURVA 600 GR. FIBRA VIDRIO	6	2	7	196781	MAZA GOMA NEGRA 455 GR. FIBRA	6	4	6
113503	EXPOSITOR 1000x450x2200 MM	1			196787	MAZA GOMA BLANCA 455 GR. FIBRA	6	4	7
113640	GANCHO PORTAPRECIOS Ø5 - 200 MM	30			197471	CORTAFRIOS 300 MM PROTECTOR	6	5	1
					197473	CORTAFRIOS 350 MM PROTECTOR	6	5	2
					197475	CORTAFRIOS 400 MM PROTECTOR	5	5	3
					198625	HACHA 700 GR. HICKORY	6	5	4
					186354	HACHA 1000 GR. FIBRA VIDRIO	4	5	5



Cód. N° Piezas P.V.P. unid. €

113735 201 **3.377,68** 1

ÍNDICE CÓDIGO-PÁGINA

CÓD. PÁG.	CÓD. PÁG.	CÓD. PÁG.	CÓD. PÁG.	CÓD. PÁG.	CÓD. PÁG.	CÓD. PÁG.	CÓD. PÁG.
101200 87	106209 99	108380 110	111347 305	113640 418	119022 172	119241 171	120275 264
101201 87	106210 99	108390 107	111350 304	113645 418	119023 172	119242 171	120300 264
101202 87	106211 99	108392 107	111351 304	113650 418	119024 172	119302 184	120325 264
101203 87	106212 99	108395 352	111352 304	113715 419	119025 172	119303 184	120350 264
101206 86	106213 99	108400 271	111353 304	113720 419	119029 172	119304 184	120375 264
101208 86	106214 99	108405 271	111355 303	113725 420	119030 172	119305 184	120400 264
101209 86	106220 99	108410 271	111360 303	113730 421	119031 172	119306 184	120425 264
101210 88	106225 99	108415 270	111365 303	113735 421	119032 172	119308 184	120450 264
101217 88	106230 99	108420 270	111370 303	113740 420	119033 172	119310 184	120475 264
101218 99	106235 99	108425 270	111375 303	114002 103	119035 173	119311 184	120500 264
101220 99	107101 87	108490 271	111380 303	114003 103	119036 173	119312 184	120525 264
101222 99	108002 110	108492 271	111385 303	114005 103	119038 173	119321 184	120550 264
101260 363	108003 110	108505 273	111390 303	114006 103	119039 173	119322 184	120575 264
101265 363	108006 110	108510 273	111410 302	114007 103	119040 172	119330 185	120600 264
101267 363	108015 111	108520 272	111412 302	114010 103	119041 172	119331 185	120625 264
101270 116	108020 111	108525 272	111414 302	114015 103	119042 172	119332 188	120650 264
101272 114	108025 113	108530 272	111415 303	114016 103	119043 172	119335 185	120675 264
101274 116	108030 114	108550 274	111418 302	114017 103	119049 174	119336 188	120700 264
101276 116	108032 114	108555 274	111419 303	114051 26	119050 174	119338 188	120725 264
101277 115	108035 112	108560 274	111424 302	114052 26	119055 174	119339 188	120750 264
101278 115	108046 106	109007 102	111425 303	114053 23	119057 175	119341 185	120775 264
101279 115	108048 106	109009 102	111436 302	114054 24	119058 175	119344 184	120800 264
101280 115	108052 106	109015 102	111445 352	114055 25	119060 175	119345 184	120825 264
101282 115	108055 106	109101 101	111505 309	114056 25	119074 173	119346 184	120850 264
101300 87	108057 106	109102 101	111506 309	114057 24	119075 173	119347 184	120875 264
101301 87	108075 108	109103 101	111507 309	114058 24	119076 173	119348 184	120900 264
101302 87	108080 118	109104 101	111510 308	114059 26	119077 173	119349 184	120925 264
101303 86	108081 118	109105 101	111511 308	114060 23	119078 173	119350 184	120950 264
101304 86	108085 118	110301 88	111513 307	114061 23	119079 173	119351 184	120975 264
101310 87	108086 118	110302 88	111514 307	114062 25	119080 173	119352 184	121000 264
101312 86	108090 114	110303 88	111520 307	114063 25	119081 173	119353 184	121025 264
101400 33	108095 114	110304 86	111522 308	114064 23	119082 173	119361 187	121050 264
101410 33	108100 117	110305 86	111524 308	114065 24	119083 173	119362 187	121075 264
101450 31	108105 117	110307 88	111525 307	115100 92	119084 173	119363 187	121100 264
101460 31	108110 117	110309 88	111534 308	115105 92	119085 175	119364 187	121125 264
101801 94	108120 117	110310 88	111535 308	115115 91	119090 174	119365 187	121150 264
101802 94	108210 111	110311 88	111536 308	115120 91	119091 172	119366 187	121175 264
101803 94	108215 111	110320 105	111537 308	115125 91	119092 172	119367 187	121200 264
101804 93	108220 112	110322 105	111540 309	115130 91	119093 172	119368 187	121225 264
101805 93	108225 112	111100 88	111545 309	115135 91	119094 172	119369 187	121250 264
101810 94	108230 114	111101 88	111550 309	115140 91	119095 172	119370 187	121275 264
101811 94	108235 112	111199 91	111551 309	118001 285	119096 172	119371 187	121300 264
101812 93	108240 111	111200 91	113142 97	118002 285	119097 172	119372 187	121320 264
101813 93	108250 306	111201 91	113144 97	118003 285	119098 172	119373 187	121330 265
101815 94	108255 306	111212 302	113155 96	118004 285	119099 175	119375 187	121350 265
101821 94	108260 306	111214 302	113160 97	118005 285	119100 176	119501 182	121500 47
101822 94	108265 306	111218 302	113165 96	118006 285	119102 177	119502 182	121502 47
101823 93	108300 117	111224 302	113170 96	118007 285	119105 177	119503 182	121510 47
101824 93	108302 117	111236 302	113175 96	118010 285	119107 176	119515 182	121518 49
101825 94	108315 113	111308 302	113180 96	118015 352	119110 176	119525 182	121524 49
101826 94	108332 112	111310 302	113185 96	118020 352	119115 176	119529 182	121530 173
101830 95	108337 112	111312 302	113190 97	118030 352	119117 177	119530 182	121535 49
101835 95	108342 112	111314 302	113192 97	118035 353	119120 177	119531 182	121550 354
101840 95	108352 109	111318 302	113194 97	118050 141	119125 177	119535 182	121555 354
101845 95	108355 109	111324 302	113490 64	118052 141	119130 177	119536 182	121560 48
101848 95	108356 109	111330 305	113492 64	118054 141	119132 321	119537 182	121562 48
101860 95	108360 109	111336 302	113494 64	119004 172	119134 321	119538 182	121564 48
101862 93	108361 109	111338 305	113496 64	119005 172	119135 354	119539 182	121566 48
102201 87	108364 109	111339 305	113498 64	119006 172	119140 354	119540 182	121568 48
104101 87	108366 109	111340 304	113499 64	119007 172	119150 169	120100 264	121570 49
106202 99	108367 109	111341 304	113503 416	119008 172	119201 171	120125 264	121572 49
106203 99	108368 109	111342 304	113626 416	119010 172	119205 171	120150 264	122003 266
106204 99	108369 109	111343 304	113630 417	119012 173	119206 171	120175 264	122004 266
106206 99	108370 107	111344 305	113631 417	119014 173	119208 171	120200 264	122005 266
106207 99	108375 108	111345 305	113635 417	119016 173	119231 171	120225 264	122006 266
106208 99	108377 108	111346 305	113636 418	119018 173	119232 171	120250 264	122007 266

CÓD. PÁG.	CÓD. PÁG.	CÓD. PÁG.	CÓD. PÁG.	CÓD. PÁG.	CÓD. PÁG.	CÓD. PÁG.	CÓD. PÁG.
122008 266	122250 359	125050 252	125372 397	125564 398	125748 400	126220 405	126374 406
122009 266	122255 359	125060 252	125374 397	125566 398	125750 400	126222 405	126376 406
122010 266	122300 356	125200 395	125380 397	125568 398	125770 400	126224 405	126380 406
122011 266	122305 356	125202 395	125382 397	125580 399	125772 400	126226 405	126382 406
122012 266	122310 356	125210 395	125384 397	125581 399	125774 400	126228 405	126384 406
122013 266	122315 356	125212 395	125386 397	125582 399	125776 400	126230 405	126386 406
122014 266	122330 358	125214 395	125388 397	125583 399	125780 400	126232 405	126388 406
122015 266	122340 265	125220 395	125390 397	125584 399	125782 400	126234 405	126390 406
122016 266	122342 265	125222 395	125392 397	125585 399	125784 400	126236 405	126392 406
122018 266	122345 265	125230 395	125394 397	125586 399	125786 400	126238 405	126394 406
122020 266	122347 265	125232 395	125400 397	125587 399	125788 400	126240 405	126396 406
122022 266	122350 356	125235 395	125402 397	125588 399	125790 400	126242 405	126398 406
122036 266	122355 356	125238 395	125404 397	125589 399	125792 400	126244 405	126400 406
122038 266	122360 356	125240 395	125406 397	125590 399	125800 400	126246 405	126402 406
122040 266	122365 356	125242 395	125410 397	125591 399	125802 400	126248 405	126404 406
122046 266	122375 357	125244 395	125412 397	125592 399	125804 400	126250 405	126406 406
122048 266	122380 357	125246 395	125414 397	125593 399	125810 400	126252 405	126408 406
122050 266	122385 357	125248 395	125416 397	125594 399	125812 400	126254 405	126410 406
122052 266	122390 357	125252 396	125418 397	125595 399	125814 400	126256 405	126412 406
122054 266	122395 357	125254 396	125420 397	125602 399	125820 400	126258 405	126414 406
122056 266	123001 321	125260 396	125422 397	125604 399	125822 400	126260 405	126416 406
122058 266	123005 321	125262 396	125426 397	125606 399	125824 400	126262 405	126420 406
122060 266	123010 104	125264 396	125428 397	125608 399	126100 403	126264 405	126421 406
122062 266	123031 104	125266 396	125430 397	125610 399	126102 403	126266 405	126422 406
122070 267	123032 104	125268 396	125432 397	125612 399	126104 403	126268 405	126423 406
122080 267	123033 104	125270 396	125434 397	125614 399	126106 403	126270 405	126424 406
122104 266	123034 104	125276 396	125436 397	125616 399	126110 403	126272 405	126425 406
122105 266	123036 106	125278 396	125438 397	125630 399	126112 403	126274 405	126426 406
122106 266	123037 106	125280 396	125450 398	125632 399	126116 403	126280 405	126427 406
122107 266	123038 106	125282 396	125452 398	125634 399	126118 403	126282 405	126430 407
122108 266	123110 104	125284 396	125454 398	125636 399	126120 403	126284 405	126431 407
122109 266	123111 104	125286 396	125456 398	125638 399	126122 403	126286 405	126432 407
122110 266	123112 104	125288 396	125458 398	125640 399	126126 403	126288 405	126433 407
122111 266	123113 104	125290 396	125460 398	125642 399	126130 403	126290 405	126434 407
122112 266	123114 104	125292 396	125462 398	125644 399	126134 404	126292 405	126435 407
122113 266	123120 104	125294 396	125464 398	125646 399	126136 404	126294 405	126436 407
122114 266	123200 105	125296 396	125466 398	125648 399	126138 404	126296 405	126437 407
122115 266	123210 105	125298 396	125468 398	125650 399	126140 404	126298 405	126438 407
122116 266	125001 252	125302 396	125470 398	125652 399	126142 404	126300 405	126439 407
122117 266	125002 252	125304 396	125472 398	125654 399	126146 404	126302 405	126440 407
122118 266	125003 252	125306 396	125474 398	125658 399	126148 404	126304 405	126441 407
122119 266	125004 252	125308 396	125476 398	125662 399	126150 404	126306 405	126450 407
122120 266	125005 252	125310 396	125478 398	125666 399	126152 404	126308 405	126451 407
122126 266	125007 252	125312 396	125490 398	125668 399	126154 404	126320 405	126452 407
122128 266	125008 252	125314 396	125492 398	125670 399	126160 404	126322 405	126453 407
122130 266	125009 252	125316 396	125494 398	125672 399	126162 404	126324 405	126454 407
122132 266	125010 252	125318 396	125496 398	125674 399	126170 404	126326 405	126460 407
122134 266	125011 252	125320 396	125498 398	125676 399	126172 404	126328 405	126461 407
122136 266	125012 252	125322 396	125500 398	125678 399	126174 404	126330 405	126462 407
122146 266	125013 252	125324 396	125510 398	125686 399	126176 404	126332 405	126463 407
122148 266	125014 252	125330 397	125512 398	125688 399	126178 404	126334 405	126464 407
122150 266	125015 252	125332 397	125514 398	125690 399	126180 404	126336 405	126465 407
122152 266	125016 252	125334 397	125516 398	125700 399	126182 404	126338 405	126466 407
122154 266	125017 252	125336 397	125518 398	125702 399	126184 404	126340 405	126467 407
122156 266	125019 252	125338 397	125520 398	125704 399	126186 404	126350 406	126468 407
122170 267	125020 252	125340 397	125522 398	125706 399	126188 404	126352 406	126469 407
122180 267	125021 252	125342 397	125524 398	125710 400	126190 404	126354 406	126470 407
122200 358	125022 252	125344 397	125526 398	125712 400	126192 404	126356 406	126471 407
122204 358	125023 252	125346 397	125528 398	125720 400	126194 404	126358 406	126472 407
122206 358	125024 252	125348 397	125540 398	125722 400	126196 404	126360 406	126473 407
122210 356	125035 252	125360 397	125542 398	125730 400	126198 404	126362 406	126474 407
122212 356	125036 252	125362 397	125544 398	125732 400	126210 405	126364 406	126475 407
122214 356	125037 252	125364 397	125546 398	125740 400	126212 405	126366 406	126476 407
122220 358	125038 252	125366 397	125548 398	125742 400	126214 405	126368 406	126477 407
122225 358	125039 252	125368 397	125560 398	125744 400	126216 405	126370 406	126478 407
122230 358	125040 252	125370 397	125562 398	125746 400	126218 405	126372 406	126479 407

ÍNDICE CÓDIGO-PÁGINA

CÓD. PÁG.	CÓD. PÁG.	CÓD. PÁG.	CÓD. PÁG.	CÓD. PÁG.	CÓD. PÁG.	CÓD. PÁG.	CÓD. PÁG.
126480 407	126591 409	126766 412	126960 414	127135 374	127207 376	127288 386	127390 382
126481 407	126592 409	126768 412	127008 371	127136 374	127208 376	127289 386	127391 382
126490 407	126593 409	126770 412	127010 371	127137 374	127209 376	127290 386	127392 382
126491 407	126594 409	126780 412	127012 371	127138 374	127210 376	127291 386	127393 382
126492 407	126595 409	126782 412	127013 371	127139 374	127211 376	127292 386	127394 382
126493 407	126596 409	126784 412	127015 371	127140 374	127212 376	127293 386	127395 382
126494 407	126597 409	126786 412	127016 371	127141 374	127213 376	127294 386	127396 382
126495 407	126598 409	126788 412	127018 371	127142 374	127214 376	127295 386	127397 382
126496 407	126599 409	126790 412	127019 371	127143 374	127215 376	127296 386	127398 382
126497 407	126600 409	126800 412	127020 371	127144 374	127216 376	127297 386	127399 382
126498 407	126601 409	126802 412	127021 371	127145 374	127217 376	127298 386	127400 384
126500 407	126602 409	126804 412	127024 371	127146 374	127218 376	127299 386	127401 384
126501 407	126603 409	126806 412	127026 371	127147 374	127219 376	127300 379	127402 384
126502 407	126604 409	126808 412	127027 371	127148 374	127220 375	127302 379	127403 384
126503 407	126605 409	126810 412	127029 372	127149 374	127221 375	127304 379	127406 384
126504 407	126610 409	126812 412	127030 372	127150 374	127222 375	127307 379	127407 384
126505 407	126612 409	126814 412	127031 372	127151 374	127223 375	127308 379	127408 384
126506 407	126616 409	126816 412	127032 372	127152 374	127225 375	127309 379	127409 384
126507 407	126618 409	126818 412	127035 372	127153 374	127226 375	127310 379	127412 384
126510 408	126620 410	126820 412	127040 372	127154 374	127230 377	127311 379	127413 384
126512 408	126630 410	126822 412	127042 372	127155 374	127231 377	127312 379	127414 384
126514 408	126632 410	126824 412	127044 372	127156 374	127232 377	127313 379	127415 384
126516 408	126634 410	126826 412	127045 372	127157 374	127233 377	127315 379	127416 384
126518 408	126636 410	126828 412	127047 372	127158 374	127234 377	127316 379	127417 384
126520 408	126638 410	126830 412	127048 372	127159 374	127235 377	127317 379	127418 384
126522 408	126640 410	126840 412	127050 373	127160 377	127236 377	127318 379	127419 384
126524 408	126642 410	126850 412	127052 373	127161 377	127237 377	127319 379	127420 384
126526 408	126644 410	126852 412	127053 373	127162 377	127238 377	127325 386	127425 384
126528 408	126646 410	126854 412	127055 373	127163 377	127239 377	127326 386	127430 381
126530 408	126650 410	126856 412	127057 373	127165 374	127240 377	127327 386	127431 381
126532 408	126652 410	126860 413	127058 373	127166 374	127241 377	127350 389	127432 381
126534 408	126656 410	126862 413	127100 373	127167 374	127242 377	127351 389	127433 381
126536 408	126658 410	126864 413	127101 373	127168 374	127243 377	127352 389	127434 381
126538 408	126665 410	126866 413	127102 373	127170 378	127244 377	127353 389	127435 381
126540 408	126670 410	126870 413	127103 373	127171 378	127245 377	127354 389	127436 381
126542 408	126680 411	126872 413	127104 373	127172 378	127246 377	127355 389	127437 381
126544 408	126682 411	126874 413	127105 373	127173 378	127247 377	127356 389	127438 381
126546 408	126684 411	126876 413	127106 373	127175 374	127248 377	127357 389	127439 381
126548 408	126686 411	126878 413	127107 373	127176 374	127249 377	127358 389	127440 381
126560 409	126688 411	126880 413	127108 373	127180 375	127250 377	127359 389	127445 381
126561 409	126690 411	126882 413	127109 373	127181 375	127251 377	127360 385	127446 381
126562 409	126700 411	126884 413	127110 373	127182 375	127252 377	127361 385	127447 381
126563 409	126702 411	126890 413	127111 373	127183 375	127253 377	127362 385	127448 381
126564 409	126704 411	126892 413	127112 373	127184 375	127254 377	127363 385	127449 381
126565 409	126706 411	126894 413	127113 373	127185 375	127255 377	127365 382	127450 381
126566 409	126710 411	126896 413	127114 373	127186 375	127256 377	127366 382	127451 381
126567 409	126712 411	126900 413	127115 373	127187 375	127257 377	127367 382	127452 381
126568 409	126714 411	126902 413	127116 373	127188 375	127258 377	127368 382	127455 381
126569 409	126720 411	126904 413	127117 373	127189 375	127259 377	127369 382	127456 381
126570 409	126722 411	126906 413	127118 373	127190 375	127270 378	127370 382	127457 381
126571 409	126724 411	126908 413	127119 373	127191 375	127271 378	127371 382	127458 381
126572 409	126726 411	126910 413	127120 373	127192 375	127272 378	127372 382	127459 381
126573 409	126728 411	126920 413	127121 373	127193 375	127273 378	127373 382	127460 381
126574 409	126730 411	126925 413	127122 373	127194 375	127274 378	127375 382	127461 381
126575 409	126732 411	126930 414	127123 373	127195 375	127275 378	127376 382	127462 381
126576 409	126734 411	126932 414	127124 373	127196 375	127276 378	127377 382	127463 381
126577 409	126736 411	126934 414	127125 373	127197 375	127277 378	127380 382	127464 381
126578 409	126740 411	126936 414	127126 374	127198 375	127278 378	127381 382	127465 381
126579 409	126742 411	126938 414	127127 374	127199 377	127279 378	127382 382	127471 381
126580 409	126744 411	126940 414	127128 374	127200 376	127280 378	127383 382	127472 381
126581 409	126746 411	126942 414	127129 374	127201 376	127281 378	127384 382	127473 381
126582 409	126750 411	126944 414	127130 374	127202 376	127282 378	127385 382	127474 381
126583 409	126752 411	126950 414	127131 374	127203 376	127284 386	127386 382	127475 381
126584 409	126760 412	126952 414	127132 374	127204 376	127285 386	127387 382	127476 381
126585 409	126762 412	126956 414	127133 374	127205 376	127286 386	127388 382	127477 381
126590 409	126764 412	126958 414	127134 374	127206 376	127287 386	127389 382	127478 381

CÓD. PÁG.	CÓD. PÁG.	CÓD. PÁG.	CÓD. PÁG.	CÓD. PÁG.	CÓD. PÁG.	CÓD. PÁG.	CÓD. PÁG.
127479 381	127567 381	127656 376	127749 378	127855 385	127945 391	128116 373	128188 375
127480 381	127568 381	127657 376	127750 378	127856 385	127946 391	128117 373	128189 375
127481 381	127569 381	127658 376	127751 378	127857 385	127950 391	128118 373	128190 375
127498 383	127570 381	127659 376	127752 378	127858 385	127952 391	128119 373	128191 375
127499 383	127571 381	127660 376	127753 378	127859 385	127954 391	128120 373	128192 375
127500 383	127572 381	127661 376	127760 379	127860 385	127956 391	128121 373	128193 375
127501 383	127573 381	127662 376	127761 379	127861 385	127958 391	128122 373	128194 375
127502 382	127574 381	127665 377	127762 379	127862 385	127960 392	128123 373	128195 375
127503 382	127575 381	127666 377	127763 379	127863 385	127961 392	128124 373	128196 375
127504 382	127576 381	127667 377	127764 379	127864 385	127965 392	128125 373	128197 375
127505 382	127577 381	127668 377	127765 379	127865 385	127966 392	128126 374	128198 375
127510 380	127578 381	127670 377	127766 379	127866 385	127967 392	128127 374	128199 377
127511 380	127579 381	127671 377	127767 379	127867 385	127970 392	128128 374	128200 376
127512 380	127580 381	127672 377	127768 379	127868 385	127971 392	128129 374	128201 376
127513 380	127581 381	127673 377	127769 379	127869 385	127972 392	128130 374	128202 376
127514 380	127582 381	127674 377	127770 379	127870 385	127973 392	128131 374	128203 376
127515 380	127583 381	127675 377	127771 379	127871 385	127974 392	128132 374	128204 376
127516 380	127584 381	127676 377	127772 379	127872 386	127975 392	128133 374	128205 376
127517 380	127585 381	127677 377	127773 379	127873 386	127976 392	128134 374	128206 376
127518 380	127586 381	127680 377	127774 379	127874 386	127977 392	128135 374	128207 376
127519 380	127587 381	127681 377	127800 379	127875 386	128008 371	128136 374	128208 376
127520 380	127600 388	127682 377	127801 379	127876 386	128009 371	128137 374	128209 376
127521 380	127605 375	127683 377	127802 379	127880 386	128010 371	128138 374	128210 376
127522 380	127606 375	127684 377	127803 379	127881 386	128012 371	128139 374	128211 376
127523 380	127607 375	127685 377	127804 379	127882 387	128015 371	128140 374	128212 376
127524 380	127608 375	127686 377	127805 380	127883 387	128016 371	128141 374	128213 376
127525 380	127609 375	127687 377	127806 380	127884 387	128018 371	128142 374	128214 376
127526 380	127610 375	127688 377	127807 380	127885 387	128019 371	128143 374	128215 376
127527 380	127611 375	127689 377	127808 380	127886 387	128020 371	128144 374	128216 376
127528 380	127612 375	127690 377	127809 380	127887 387	128021 371	128145 374	128217 376
127529 380	127613 375	127691 377	127810 380	127890 388	128024 371	128146 374	128218 376
127530 380	127614 375	127695 377	127811 380	127895 388	128026 371	128147 374	128219 376
127531 380	127615 375	127696 377	127812 380	127896 388	128027 371	128148 374	128220 375
127532 380	127620 376	127697 377	127813 380	127898 388	128029 372	128149 374	128221 375
127533 380	127621 376	127698 377	127814 380	127899 388	128030 372	128150 374	128222 375
127535 380	127622 376	127700 378	127815 380	127900 388	128031 372	128151 374	128223 375
127536 380	127623 376	127701 378	127816 380	127901 388	128032 372	128152 374	128225 375
127537 380	127624 376	127702 378	127817 380	127905 389	128035 372	128153 374	128226 375
127538 380	127625 376	127703 378	127818 380	127907 389	128040 372	128154 374	128230 377
127539 380	127626 376	127704 378	127819 380	127908 389	128042 372	128155 374	128231 377
127540 380	127627 376	127705 378	127820 380	127909 389	128044 372	128156 374	128232 377
127541 380	127628 376	127706 378	127830 384	127910 389	128045 372	128157 374	128233 377
127542 380	127629 376	127708 378	127831 384	127912 389	128047 372	128158 374	128234 377
127543 380	127630 376	127709 378	127832 384	127915 390	128048 372	128159 374	128235 377
127544 380	127631 376	127710 378	127833 384	127916 390	128050 373	128160 377	128236 377
127545 380	127635 376	127711 378	127834 384	127917 390	128052 373	128161 377	128237 377
127546 380	127636 376	127715 378	127835 384	127918 390	128053 373	128162 377	128238 377
127547 380	127637 376	127716 378	127836 384	127920 390	128055 373	128163 377	128239 377
127548 380	127638 376	127717 378	127837 384	127921 390	128057 373	128165 374	128240 377
127549 380	127639 376	127718 378	127838 384	127922 390	128058 373	128166 374	128241 377
127550 380	127640 376	127719 378	127839 384	127923 390	128100 373	128167 374	128242 377
127551 380	127641 376	127730 378	127840 384	127925 390	128101 373	128168 374	128243 377
127552 380	127642 376	127731 378	127841 384	127926 390	128102 373	128170 378	128244 377
127553 380	127643 376	127732 378	127842 384	127927 390	128103 373	128171 378	128245 377
127555 381	127644 376	127733 378	127843 384	127928 390	128104 373	128172 378	128246 377
127556 381	127645 376	127734 378	127844 384	127930 390	128105 373	128173 378	128247 377
127557 381	127646 376	127735 378	127845 384	127931 390	128106 373	128175 374	128248 377
127558 381	127647 376	127736 378	127846 384	127932 390	128107 373	128176 374	128249 377
127559 381	127648 376	127737 378	127847 384	127933 390	128108 373	128180 375	128250 377
127560 381	127649 376	127738 378	127848 384	127934 390	128109 373	128181 375	128251 377
127561 381	127650 376	127739 378	127849 385	127935 390	128110 373	128182 375	128252 377
127562 381	127651 376	127740 378	127850 385	127936 390	128111 373	128183 375	128253 377
127563 381	127652 376	127745 378	127851 385	127940 390	128112 373	128184 375	128254 377
127564 381	127653 376	127746 378	127852 385	127941 390	128113 373	128185 375	128255 377
127565 381	127654 376	127747 378	127853 385	127942 390	128114 373	128186 375	128256 377
127566 381	127655 376	127748 378	127854 385	127943 390	128115 373	128187 375	128257 377

ÍNDICE CÓDIGO-PÁGINA

CÓD. PÁG.	CÓD. PÁG.	CÓD. PÁG.	CÓD. PÁG.	CÓD. PÁG.	CÓD. PÁG.	CÓD. PÁG.	CÓD. PÁG.
128258 377	128368 382	128455 381	128547 380	128637 376	128716 378	128836 384	128920 390
128259 377	128369 382	128456 381	128548 380	128638 376	128717 378	128837 384	128921 390
128270 378	128370 382	128457 381	128549 380	128639 376	128718 378	128838 384	128922 390
128271 378	128371 382	128458 381	128550 380	128640 376	128719 378	128839 384	128923 390
128272 378	128372 382	128459 381	128551 380	128641 376	128730 378	128840 384	128925 390
128273 378	128373 382	128460 381	128552 380	128642 376	128731 378	128841 384	128926 390
128274 378	128375 382	128461 381	128553 380	128643 376	128732 378	128842 384	128927 390
128275 378	128376 382	128462 381	128555 381	128644 376	128733 378	128843 384	128928 390
128276 378	128377 382	128463 381	128556 381	128645 376	128734 378	128844 384	128930 390
128277 378	128380 382	128464 381	128557 381	128646 376	128735 378	128845 384	128931 390
128278 378	128381 382	128465 381	128558 381	128647 376	128736 378	128846 384	128932 390
128279 378	128382 382	128471 381	128559 381	128648 376	128737 378	128847 384	128933 390
128280 378	128383 382	128472 381	128560 381	128649 376	128738 378	128848 384	128934 390
128281 378	128384 382	128473 381	128561 381	128650 376	128739 378	128849 385	128935 390
128282 378	128385 382	128474 381	128562 381	128651 376	128740 378	128850 385	128936 390
128284 386	128386 382	128475 381	128563 381	128652 376	128745 378	128851 385	128940 390
128285 386	128387 382	128476 381	128564 381	128653 376	128746 378	128852 385	128941 390
128286 386	128388 382	128477 381	128565 381	128654 376	128747 378	128853 385	128942 390
128287 386	128389 382	128478 381	128566 381	128655 376	128748 378	128854 385	128943 390
128288 386	128390 382	128479 381	128567 381	128656 376	128749 378	128855 385	128945 391
128289 386	128391 382	128480 381	128568 381	128657 376	128750 378	128856 385	128946 391
128290 386	128392 382	128481 381	128569 381	128658 376	128751 378	128857 385	128950 391
128291 386	128393 382	128498 383	128570 381	128659 376	128752 378	128858 385	128952 391
128292 386	128394 382	128499 383	128571 381	128660 376	128753 378	128859 385	128954 391
128293 386	128395 382	128500 383	128572 381	128661 376	128760 379	128860 385	128956 391
128294 386	128396 382	128501 383	128573 381	128662 376	128761 379	128861 385	128958 391
128295 386	128397 382	128502 382	128574 381	128665 377	128762 379	128862 385	128960 392
128296 386	128398 382	128503 382	128575 381	128666 377	128763 379	128863 385	128961 392
128297 386	128399 382	128504 382	128576 381	128667 377	128764 379	128864 385	128965 392
128298 386	128400 384	128505 382	128577 381	128668 377	128765 379	128865 385	128966 392
128299 386	128401 384	128510 380	128578 381	128670 377	128766 379	128866 385	128967 392
128300 379	128402 384	128511 380	128579 381	128671 377	128767 379	128867 385	128970 392
128302 379	128403 384	128512 380	128580 381	128672 377	128768 379	128868 385	128971 392
128304 379	128406 384	128513 380	128581 381	128673 377	128769 379	128869 385	128972 392
128307 379	128407 384	128514 380	128582 381	128674 377	128770 379	128870 385	128973 392
128308 379	128408 384	128515 380	128583 381	128675 377	128771 379	128871 385	128974 392
128309 379	128409 384	128516 380	128584 381	128676 377	128772 379	128872 386	128975 392
128310 379	128412 384	128517 380	128585 381	128677 377	128773 379	128873 386	128976 392
128311 379	128413 384	128518 380	128586 381	128680 377	128774 379	128874 386	128977 392
128312 379	128414 384	128519 380	128587 381	128681 377	128800 379	128875 386	129020 392
128313 379	128415 384	128520 380	128600 388	128682 377	128801 379	128876 386	129021 392
128315 379	128416 384	128521 380	128605 375	128683 377	128802 379	128880 386	129022 392
128316 379	128417 384	128522 380	128606 375	128684 377	128803 379	128881 386	129023 392
128317 379	128418 384	128523 380	128607 375	128685 377	128804 379	128882 387	129024 392
128318 379	128419 384	128524 380	128608 375	128686 377	128805 380	128883 387	129025 392
128319 379	128420 384	128525 380	128609 375	128687 377	128806 380	128884 387	129120 392
128325 386	128425 384	128526 380	128610 375	128688 377	128807 380	128885 387	129121 392
128326 386	128430 381	128527 380	128611 375	128689 377	128808 380	128886 387	129122 392
128327 386	128431 381	128528 380	128612 375	128690 377	128809 380	128887 387	129123 392
128350 389	128432 381	128529 380	128613 375	128691 377	128810 380	128890 388	129124 392
128351 389	128433 381	128530 380	128614 375	128695 377	128811 380	128891 388	129125 392
128352 389	128434 381	128531 380	128615 375	128696 377	128812 380	128895 388	129704 21
128353 389	128435 381	128532 380	128620 376	128697 377	128813 380	128896 388	129705 43
128354 389	128436 381	128533 380	128621 376	128698 377	128814 380	128898 388	129706 43
128355 389	128437 381	128535 380	128622 376	128700 378	128815 380	128899 388	129714 19
128356 389	128438 381	128536 380	128623 376	128701 378	128816 380	128900 388	129715 40
128357 389	128439 381	128537 380	128624 376	128702 378	128817 380	128901 388	129716 19
128358 389	128440 381	128538 380	128625 376	128703 378	128818 380	128905 389	129719 21
128359 389	128445 381	128539 380	128626 376	128704 378	128819 380	128907 389	129720 40
128360 385	128446 381	128540 380	128627 376	128705 378	128820 380	128908 389	129724 17
128361 385	128447 381	128541 380	128628 376	128706 378	128830 384	128909 389	129725 39
128362 385	128448 381	128542 380	128629 376	128708 378	128831 384	128910 389	129727 17
128363 385	128449 381	128543 380	128630 376	128709 378	128832 384	128915 390	129750 66
128365 382	128450 381	128544 380	128631 376	128710 378	128833 384	128916 390	129755 66
128366 382	128451 381	128545 380	128635 376	128711 378	128834 384	128917 390	129800 54
128367 382	128452 381	128546 380	128636 376	128715 378	128835 384	128918 390	129805 54

CÓD.	PÁG.	CÓD.	PÁG.	CÓD.	PÁG.	CÓD.	PÁG.	CÓD.	PÁG.	CÓD.	PÁG.	CÓD.	PÁG.
129810	55	135019	268	144026	247	164021	145	170165	228	170404	178	170572	105
129815	55	135020	268	144027	247	164022	145	170167	228	170405	178	170575	89
129820	56	135021	268	144030	247	164023	145	170170	229	170406	178	170576	100
129825	56	135022	268	144031	247	164024	145	170171	229	170408	178	170577	100
129830	56	135051	268	144032	247	164025	145	170172	229	170412	179	170578	100
129835	56	135070	268	144035	245	170003	122	170176	236	170413	178	170579	100
129840	57	135080	268	144036	245	170004	122	170177	236	170414	178	170580	90
129845	57	136001	267	144040	246	170005	122	170178	236	170415	178	170582	100
129850	57	136002	267	144045	246	170007	122	170179	236	170418	179	170584	100
129855	57	136003	267	144046	247	170011	122	170180	125	170419	178	170585	100
129860	58	136004	267	144055	246	170014	122	170182	125	170420	178	170586	100
129862	59	136005	267	144065	246	170016	122	170183	125	170421	178	170587	100
129864	59	136006	267	144075	246	170018	122	170184	125	170422	178	170588	100
129866	59	136008	267	144086	246	170019	122	170203	128	170423	178	170590	90
129868	59	136010	267	144087	246	170021	122	170204	128	170426	179	170595	90
129870	59	136012	267	144088	246	170024	122	170206	128	170427	179	170598	107
129872	59	136014	267	144092	273	170026	122	170208	128	170428	179	170602	103
129874	59	136205	267	144093	244	170027	122	170212	128	170429	179	170604	103
129876	59	136208	267	144097	273	170030	122	170214	128	170430	178	170605	154
129878	60	138001	268	144098	247	170080	122	170215	128	170431	178	170607	154
129880	60	138002	268	144099	247	170081	122	170217	128	170432	178	170609	154
129882	61	138003	268	145101	145	170082	122	170218	128	170433	178	170610	157
129884	61	138004	238	145102	145	170086	122	170220	128	170440	178	170612	157
129886	61	138005	238	145103	145	170101	125	170221	128	170441	178	170615	159
129888	61	138006	238	145104	145	170102	125	170222	128	170442	178	170617	159
131002	257	138007	238	145105	145	170103	125	170223	128	170443	178	170622	155
131004	257	138008	238	145106	145	170104	125	170224	128	170444	178	170650	143
131006	257	138010	268	145107	145	170105	125	170280	128	170445	178	170655	143
131008	257	138011	268	145108	145	170106	125	170282	128	170446	186	170660	143
131010	257	138012	268	145109	145	170107	125	170284	128	170448	179	170665	143
131011	257	138013	268	145110	145	170108	125	170338	131	170449	179	170670	143
131012	257	138014	268	149001	322	170109	125	170339	131	170450	179	170675	143
131014	257	138021	238	149002	322	170110	125	170340	131	170451	180	170681	153
131016	257	140001	322	149003	322	170111	125	170341	131	170452	183	170682	153
131018	257	140002	322	149004	322	170112	125	170342	131	170454	181	170683	153
131020	257	140003	322	149050	322	170113	125	170343	131	170457	181	170684	153
131022	257	140004	322	149055	322	170114	125	170344	131	170461	181	170685	153
131024	257	140005	322	149081	322	170115	125	170345	131	170463	180	170686	153
131031	257	140006	322	149086	322	170116	125	170346	131	170465	180	170687	153
131032	257	140007	322	149087	322	170117	125	170347	131	170490	170	170688	153
131033	257	140008	322	151010	344	170118	125	170348	131	170492	170	170690	153
131110	257	140009	322	151012	344	170119	125	170349	131	170494	170	170692	153
131112	257	140010	322	151015	345	170120	125	170350	131	170502	98	170695	170
131114	257	140012	238	151017	345	170121	125	170351	131	170503	98	170712	196
131116	257	140013	238	151020	345	170122	125	170352	131	170504	98	170715	196
131117	257	140014	238	151022	345	170123	125	170353	131	170505	98	170718	196
131118	257	140015	238	151025	345	170124	125	170354	131	170506	98	170720	206
131120	257	140016	238	151027	345	170125	125	170355	131	170507	98	170725	202
135001	268	140019	239	151030	345	170126	125	170356	131	170508	98	170730	216
135002	268	140020	238	151032	345	170127	125	170357	131	170509	90	170735	194
135003	268	140021	238	151036	346	170128	125	170358	131	170516	89	170742	32
135004	268	140022	238	151038	346	170130	313	170360	131	170518	89	170745	191
135005	268	140023	238	151040	346	170135	232	170362	131	170520	89	170751	196
135006	268	140024	238	151042	346	170136	232	170365	131	170528	90	170752	199
135007	268	140025	238	151050	347	170137	232	170367	131	170529	98	170756	206
135008	268	140026	238	151052	347	170140	230	170369	131	170530	89	170757	209
135009	268	140029	238	151054	347	170142	230	170383	186	170535	89	170758	209
135010	268	140034	238	151060	347	170145	230	170384	186	170536	89	170769	105
135011	268	140036	238	151062	347	170146	230	170385	186	170540	92	170770	104
135012	268	140050	239	151064	347	170150	227	170386	186	170542	92	170772	104
135013	268	144000	245	151070	348	170152	227	170390	186	170550	89	170774	104
135014	268	144004	244	151072	348	170154	227	170391	186	170555	89	170776	104
135015	268	144020	247	151074	348	170156	227	170392	186	170560	89	170778	104
135016	268	144021	247	151078	348	170157	227	170395	186	170562	101	170780	70
135017	268	144022	247	151080	348	170158	227	170396	186	170564	101	170781	36
135018	268	144025	247	151082	348	170160	228	170397	186	170570	89	170785	70

ÍNDICE CÓDIGO-PÁGINA

CÓD.	PÁG.	CÓD.	PÁG.	CÓD.	PÁG.	CÓD.	PÁG.	CÓD.	PÁG.	CÓD.	PÁG.	CÓD.	PÁG.	CÓD.	PÁG.
171060	233	172273	143	183360	74	186328	228	187076	294	190072	126	190264	197	190416	207
171061	233	172274	143	183370	74	186329	226	187080	294	190074	126	190266	197	190417	207
171062	289	172275	143	186100	167	186330	228	187092	296	190076	126	190268	197	190418	207
171063	289	172277	144	186104	167	186340	230	187094	296	190078	126	190270	197	190419	207
171064	233	172280	144	186105	167	186342	230	187102	296	190090	127	190280	197	190420	207
171065	233	172281	144	186106	167	186348	233	187104	296	190095	127	190282	197	190421	207
171066	289	172282	144	186107	167	186350	233	187112	296	190100	123	190284	197	190422	207
171084	299	172283	144	186108	167	186352	233	187114	296	190102	123	190286	197	190423	207
171086	299	172286	144	186110	167	186354	233	187122	296	190104	123	190288	197	190424	207
171088	299	172288	144	186112	167	186356	233	187124	296	190106	123	190290	197	190425	207
171090	299	172295	145	186114	167	186609	249	187137	295	190108	123	190295	193	190426	207
171100	82	172296	145	186115	167	186610	249	187139	295	190110	123	190300	214	190427	207
171105	81	175001	141	186116	167	186612	248	187147	295	190112	123	190302	213	190428	207
171110	84	175002	141	186117	167	186615	248	187149	295	190114	123	190304	215	190429	207
171111	32	175003	141	186118	167	186616	248	187157	295	190116	123	190305	214	190430	207
171120	80	175004	141	186120	167	186618	249	187159	295	190118	123	190308	214	190432	207
171130	69	175005	141	186122	167	186619	249	187167	295	190120	123	190310	214	190433	208
171131	35	175006	141	186123	167	186622	249	187169	295	190122	123	190311	214	190442	161
171135	69	175007	141	186124	167	186625	249	187177	295	190124	123	190312	214	190443	161
171136	35	175008	141	186125	167	186626	248	187179	295	190126	123	190313	214	190444	161
171150	241	175009	141	186126	167	186630	248	187187	295	190128	123	190314	214	190445	161
171151	241	175010	141	186130	167	186632	248	187189	295	190130	123	190315	214	190446	161
171152	241	175011	141	186131	167	186635	248	187190	297	190132	123	190316	214	190448	161
171153	241	175012	141	186140	167	186640	248	187191	297	190140	124	190317	214	190450	153
171155	241	175013	141	186141	167	186642	248	187192	297	190145	124	190318	214	190451	153
171202	161	175014	141	186145	167	186645	248	187193	297	190157	135	190319	214	190452	153
171203	161	175015	141	186146	167	186650	250	187200	297	190158	135	190320	214	190453	153
171204	161	175016	141	186150	167	186652	248	187203	297	190159	135	190321	214	190454	153
171205	161	175017	141	186151	167	186665	250	187204	297	190160	135	190322	214	190455	153
171206	161	175018	141	186155	167	186675	300	187206	297	190161	135	190324	214	190456	153
171208	161	175019	141	186156	167	186680	300	187211	296	190162	135	190327	214	190457	153
171225	161	175020	141	186160	167	186685	300	187212	296	190163	135	190330	214	190458	153
171238	253	175021	141	186161	167	186692	300	187214	297	190164	135	190332	214	190460	156
171240	183	175022	141	186165	167	186692	300	187219	296	190165	135	190340	214	190461	156
171241	252	175023	141	186166	167	187012	294	187224	297	190166	135	190342	214	190462	156
171242	252	175024	141	186168	167	187013	294	187227	298	190167	135	190345	214	190463	156
171244	252	175025	141	186170	167	187014	294	187230	298	190168	135	190354	214	190464	156
171246	252	175026	141	186172	167	187015	294	187235	298	190169	135	190355	214	190465	156
171248	252	175027	141	186175	167	187020	294	190002	120	190171	135	190356	214	190466	156
171250	183	175030	141	186176	167	187022	294	190004	120	190172	135	190358	214	190467	156
171251	252	183100	360	186178	167	187023	294	190006	120	190174	135	190360	214	190468	156
171252	252	183105	360	186180	167	187024	294	190008	120	190180	135	190365	213	190477	137
171255	252	183107	360	186182	167	187025	294	190010	120	190182	135	190366	213	190478	137
171270	362	183110	360	186185	203	187026	294	190012	120	190202	207	190367	213	190479	137
171275	362	183112	360	186187	210	187032	294	190014	120	190204	207	190368	213	190480	137
171280	362	183113	360	186200	229	187033	294	190016	120	190206	207	190369	213	190481	137
171282	362	183114	360	186202	229	187035	294	190018	120	190208	207	190370	213	190482	137
171284	362	183115	360	186204	229	187036	294	190020	120	190210	207	190371	213	190483	137
171285	362	183117	360	186300	229	187037	294	190022	120	190212	207	190372	213	190484	137
171300	113	183120	361	186302	229	187039	294	190024	120	190214	207	190373	213	190486	137
171310	113	183121	361	186304	229	187042	294	190026	120	190216	207	190374	213	190487	137
171320	350	183122	361	186308	227	187044	294	190028	120	190218	207	190383	213	190488	137
171321	351	183123	361	186309	227	187046	294	190030	120	190220	207	190384	213	190489	137
171330	350	183124	361	186310	227	187050	294	190040	121	190222	207	190385	213	190491	137
171331	351	183125	361	186312	227	187051	294	190045	121	190224	207	190386	213	190492	137
172250	143	183126	361	186313	227	187052	294	190050	126	190226	207	190390	213	190494	137
172251	143	183127	361	186314	227	187053	294	190052	126	190228	207	190391	213	190495	137
172252	143	183128	361	186315	227	187054	294	190054	126	190230	207	190392	213	190498	207
172253	143	183129	361	186315	228	187055	294	190056	126	190240	204	190393	213	190504	325
172254	143	183130	361	186318	226	187062	294	190058	126	190250	197	190408	207	190505	325
172255	143	183300	71	186319	226	187064	294	190060	126	190252	197	190410	207	190506	325
172256	143	183310	71	186320	226	187066	294	190062	126	190254	197	190411	207	190512	326
172265	144	183350	70	186321	226	187068	294	190064	126	190256	197	190412	207	190523	207
172270	143	183352	70	186324	226	187070	294	190066	126	190258	197	190413	207	190525	207
172271	143	183354	70	186326	226	187072	294	190068	126	190260	197	190414	207	190526	207
172272	143	183356	70	186327	226	187074	294	190070	126	190262	197	190415	207	190528	207

CÓD. PÁG.	CÓD. PÁG.	CÓD. PÁG.	CÓD. PÁG.	CÓD. PÁG.	CÓD. PÁG.	CÓD. PÁG.	CÓD. PÁG.
190529 207	190676 136	190870 138	191148 126	191376 138	191640 134	191945 132	192118 197
190535 330	190678 208	190875 138	191150 126	191377 138	191652 134	191947 132	192119 199
190537 326	190680 208	190880 138	191155 126	191378 138	191654 134	191950 132	192120 197
190539 326	190681 208	190885 138	191160 126	191379 138	191656 134	191951 132	192121 197
190551 330	190682 208	190917 137	191165 126	191381 138	191658 134	191952 132	192122 197
190553 332	190683 208	190919 137	191170 126	191382 138	191660 134	191990 140	192124 197
190554 332	190684 208	190922 137	191172 126	191383 138	191662 134	191995 140	192126 197
190556 332	190685 208	190924 137	191175 126	191384 138	191664 134	192003 198	192127 197
190558 332	190686 208	190927 137	191177 126	191385 138	191666 134	192004 198	192133 195
190559 332	190687 208	190930 137	191180 127	191386 138	191668 134	192005 198	192136 195
190561 328	190688 208	190932 137	191181 127	191387 138	191670 134	192006 198	192138 195
190562 328	190689 208	190934 137	191182 127	191388 138	191672 134	192008 198	192139 195
190563 329	190690 208	190936 137	191185 127	191389 138	191675 134	192014 198	192145 199
190565 329	190691 208	190941 137	191203 123	191396 129	191682 142	192015 198	192150 200
190568 329	190692 208	190946 137	191206 123	191397 129	191684 142	192016 198	192155 199
190570 332	190693 208	190950 137	191209 123	191405 139	191686 142	192018 198	192160 200
190571 324	190694 208	190955 137	191212 123	191410 139	191688 142	192021 198	192161 200
190573 324	190695 208	190960 137	191215 123	191415 139	191690 142	192022 198	192162 200
190574 330	190696 208	190965 137	191218 123	191420 139	191692 142	192023 198	192163 200
190578 331	190697 208	190970 137	191221 123	191425 139	191695 142	192031 198	192164 200
190579 331	190698 208	190975 137	191224 123	191430 139	191697 142	192032 198	192165 200
190580 368	190699 208	190980 137	191227 123	191435 139	191805 130	192033 198	192170 200
190581 368	190700 208	190985 137	191230 123	191440 139	191810 130	192039 198	192182 194
190583 332	190702 208	191004 120	191233 123	191445 139	191815 130	192040 198	192187 193
190590 368	190703 209	191005 120	191236 123	191450 139	191820 130	192041 198	192195 193
190591 368	190705 212	191010 120	191239 123	191452 139	191825 130	192042 198	192208 202
190595 368	190706 212	191012 120	191242 123	191455 139	191830 130	192043 198	192209 202
190596 368	190707 212	191015 120	191245 123	191457 139	191835 130	192044 198	192210 202
190597 368	190708 212	191020 120	191248 123	191460 139	191840 130	192045 198	192211 202
190609 46	190710 212	191025 120	191251 123	191470 139	191845 130	192046 198	192212 202
190610 46	190712 212	191028 120	191254 123	191475 139	191850 130	192047 198	192213 202
190611 46	190720 211	191030 120	191257 123	191480 139	191855 130	192048 198	192214 202
190612 46	190725 211	191033 120	191260 123	191485 139	191860 130	192049 198	192215 202
190614 46	190727 211	191035 120	191263 123	191492 142	191862 130	192050 199	192216 202
190615 46	190730 211	191038 120	191266 123	191494 142	191864 130	192051 198	192217 202
190616 46	190740 211	191040 120	191269 123	191496 142	191865 130	192052 198	192218 202
190617 46	190741 212	191045 120	191272 123	191498 142	191866 130	192053 198	192219 202
190618 46	190745 211	191047 120	191275 123	191499 142	191868 130	192054 198	192221 202
190619 46	190746 212	191050 120	191278 123	191505 140	191869 130	192055 198	192222 202
190620 46	190750 211	191055 120	191279 123	191510 140	191870 130	192056 198	192225 203
190621 46	190751 212	191060 120	191280 124	191515 140	191872 130	192057 198	192228 202
190622 46	190755 211	191065 120	191281 123	191520 140	191874 130	192058 198	192230 202
190623 46	190756 212	191070 120	191282 123	191525 140	191876 130	192059 198	192232 202
190624 46	190760 211	191072 120	191283 123	191530 140	191877 130	192060 198	192233 202
190625 46	190761 212	191073 120	191284 123	191535 140	191880 133	192064 198	192237 202
190626 46	190765 211	191075 120	191286 124	191540 140	191881 133	192065 198	192239 202
190627 46	190767 212	191076 120	191296 124	191545 140	191882 133	192066 198	192243 201
190628 46	190768 212	191077 120	191305 129	191550 140	191885 133	192068 198	192244 201
190629 46	190770 212	191080 121	191310 129	191552 140	191891 130	192100 199	192246 202
190657 136	190771 212	191081 121	191315 129	191555 140	191900 290	192101 197	192250 203
190658 136	190774 212	191082 121	191320 129	191557 140	191905 132	192102 197	192255 203
190659 136	190775 212	191085 121	191325 129	191560 140	191907 132	192103 197	192260 203
190660 136	190776 212	191086 121	191330 129	191565 140	191910 132	192104 197	192265 203
190661 136	190777 212	191096 121	191335 129	191570 140	191915 132	192105 197	192270 203
190662 136	190824 138	191105 126	191340 129	191575 140	191920 132	192106 197	192287 201
190663 136	190827 138	191110 126	191345 129	191600 133	191925 132	192107 197	192294 208
190664 136	190830 138	191115 126	191350 129	191605 133	191926 132	192108 197	192295 208
190665 136	190832 138	191120 126	191355 129	191610 133	191927 132	192109 197	192296 208
190666 136	190836 138	191125 126	191357 129	191615 133	191928 132	192110 197	192297 208
190667 136	190838 138	191128 126	191360 129	191620 133	191930 132	192111 197	192298 208
190668 136	190841 138	191130 126	191370 138	191625 133	191932 132	192112 197	192299 208
190669 136	190846 138	191133 126	191371 138	191627 133	191935 132	192113 197	192300 208
190671 136	190850 138	191135 126	191372 138	191630 134	191937 132	192114 197	192305 209
190672 136	190855 138	191138 126	191373 138	191632 134	191939 132	192115 197	192308 206
190674 136	190860 138	191140 126	191374 138	191634 134	191941 132	192116 197	192310 206
190675 136	190865 138	191145 126	191375 138	191636 134	191943 132	192117 197	192311 206

ÍNDICE CÓDIGO-PÁGINA

CÓD. PÁG.	CÓD. PÁG.	CÓD. PÁG.	CÓD. PÁG.	CÓD. PÁG.	CÓD. PÁG.	CÓD. PÁG.	CÓD. PÁG.
192312 206	192480 211	192701 27	192863 64	193172 152	193591 165	193968 166	194175 149
192313 206	192481 212	192704 27	192864 64	193173 152	193592 165	193970 155	194176 149
192314 206	192482 212	192709 18	192866 60	193174 152	193593 165	193971 166	194177 149
192315 206	192483 212	192710 39	192867 64	193175 152	193594 165	193972 166	194178 149
192316 206	192484 212	192712 18	192868 64	193176 152	193595 165	193973 166	194179 149
192317 206	192485 212	192713 27	192871 64	193178 152	193596 165	193980 166	194180 149
192318 206	192486 212	192714 27	192872 64	193181 152	193597 165	193981 166	194182 149
192319 206	192501 207	192725 45	192873 64	193182 152	193598 165	193982 166	194184 149
192320 206	192502 207	192727 45	192875 62	193206 158	193599 165	193983 166	194200 148
192321 206	192503 207	192731 69	192876 61	193207 158	193601 166	193984 166	194205 148
192322 206	192504 207	192732 34	192877 62	193208 158	193603 165	193985 166	194215 148
192323 206	192505 207	192733 69	192878 61	193209 158	193606 166	193990 166	194220 148
192324 206	192506 207	192735 68	192881 58	193210 158	193611 166	193991 166	194805 168
192325 206	192507 207	192736 34	192885 150	193215 158	193616 166	193992 166	194806 168
192326 206	192508 207	192759 72	192886 58	193220 158	193621 166	193993 166	194807 168
192327 206	192509 207	192760 75	192890 150	193225 158	193636 165	193994 166	194808 168
192328 206	192510 207	192762 75	192891 150	193227 158	193637 165	193995 166	194809 168
192329 206	192511 207	192763 75	192892 150	193230 158	193638 165	193996 166	194810 168
192330 206	192512 207	192765 73	192893 150	193240 158	193646 165	194006 158	194811 168
192332 206	192513 207	192766 75	192895 148	193245 158	193647 165	194007 158	194812 168
192333 208	192514 207	192768 75	192897 150	193250 158	193648 165	194008 158	194813 168
192334 208	192515 207	192780 44	192898 147	193255 158	193656 165	194009 158	194815 168
192343 205	192516 207	192792 68	192900 147	193260 158	193657 165	194010 158	194820 217
192344 205	192517 207	192793 68	192910 147	193270 158	193658 165	194015 158	194836 217
192348 205	192518 209	192794 68	192920 147	193283 159	193666 165	194020 158	194841 217
192352 210	192519 216	192795 72	192930 147	193290 158	193667 165	194025 158	194846 217
192355 210	192521 216	192796 72	192940 147	193292 159	193668 165	194027 158	194850 217
192356 210	192522 216	192802 67	192945 147	193369 188	193725 169	194030 158	194855 217
192358 210	192524 216	192804 67	192948 147	193465 182	193730 169	194040 158	194860 217
192360 210	192527 216	192806 67	193002 153	193467 183	193740 168	194045 158	194865 217
192362 210	192530 216	192808 67	193003 153	193503 165	193742 168	194050 158	194870 217
192363 210	192532 216	192815 41	193004 153	193506 165	193744 168	194055 158	194875 217
192365 210	192533 216	192821 73	193005 153	193511 165	193750 168	194060 158	194880 217
192383 204	192534 216	192822 73	193006 153	193516 165	193751 168	194100 149	194885 217
192384 204	192536 216	192823 73	193007 153	193521 165	193752 168	194105 149	194886 217
192386 190	192538 216	192824 73	193008 153	193536 164	193753 168	194110 149	194887 217
192388 205	192541 216	192825 38	193009 153	193537 164	193754 168	194115 149	194888 217
192389 190	192546 216	192826 16	193010 153	193538 164	193902 155	194120 149	194890 217
192392 192	192550 216	192827 16	193012 153	193546 164	193903 155	194121 149	195205 161
192393 192	192555 216	192829 73	193014 153	193547 164	193904 155	194122 149	195206 161
192394 194	192560 216	192832 44	193015 153	193548 164	193905 155	194123 149	195207 161
192401 195	192565 216	192837 63	193017 153	193556 164	193906 155	194124 149	195208 161
192404 191	192570 216	192838 51	193019 153	193557 164	193907 155	194127 149	195209 161
192405 211	192575 216	192839 51	193022 153	193558 164	193908 155	194129 149	195210 161
192406 211	192580 215	192841 63	193025 153	193566 164	193910 155	194133 149	195211 161
192407 211	192582 215	192842 52	193070 154	193567 164	193912 155	194137 149	195212 161
192408 211	192604 45	192843 52	193071 154	193568 164	193914 155	194139 149	195213 161
192409 211	192605 200	192844 53	193082 154	193570 164	193925 155	194142 149	195214 161
192410 211	192610 203	192845 53	193102 156	193571 164	193935 166	194144 149	195227 161
192412 211	192615 203	192846 62	193103 156	193572 164	193936 166	194145 149	195228 161
192414 211	192620 210	192847 62	193104 156	193573 164	193938 166	194146 149	195230 161
192417 211	192625 210	192848 62	193105 156	193574 164	193940 166	194147 149	195232 161
192420 211	192630 216	192849 63	193106 156	193575 164	193942 166	194148 149	195233 161
192425 211	192632 216	192850 62	193107 156	193576 164	193944 166	194149 149	195240 162
192427 211	192648 224	192851 63	193108 156	193578 164	193945 166	194150 149	195245 162
192430 211	192649 224	192852 63	193110 156	193580 164	193946 166	194151 149	195250 162
192440 211	192650 224	192853 63	193112 156	193581 165	193948 166	194152 149	195255 161
192445 211	192652 224	192854 59	193114 156	193582 165	193950 166	194153 149	195261 160
192450 211	192665 61	192855 60	193125 156	193583 165	193952 166	194154 149	195262 160
192455 211	192675 65	192856 59	193130 156	193584 165	193954 166	194157 149	195263 160
192460 211	192676 65	192857 59	193131 157	193585 165	193961 166	194159 149	195264 160
192470 211	192677 65	192858 60	193140 156	193586 165	193962 166	194163 149	195265 160
192475 212	192678 41	192859 59	193144 152	193587 165	193963 166	194167 149	195266 160
192476 212	192679 20	192860 59	193145 152	193588 165	193964 166	194169 149	195268 160
192477 212	192680 20	192861 60	193148 153	193589 165	193965 166	194172 149	195270 160
192478 212	192699 45	192862 64	193171 152	193590 165	193967 166	194174 149	195271 160

CÓD. PÁG.	CÓD. PÁG.	CÓD. PÁG.	CÓD. PÁG.	CÓD. PÁG.	CÓD. PÁG.	CÓD. PÁG.	CÓD. PÁG.
195274 160	195920 280	196421 299	196654 226	196911 239	197076 262	197450 241	197610 258
195282 162	195921 280	196423 299	196657 226	196915 240	197079 262	197455 241	197612 258
195284 162	195925 280	196430 299	196658 226	196916 239	197083 262	197456 241	197614 258
195309 160	195926 280	196440 299	196663 226	196920 240	197086 262	197460 242	197620 259
195310 160	195930 280	196450 299	196664 226	196921 239	197089 262	197461 242	197622 259
195315 160	195931 280	196460 299	196665 230	196925 240	197092 262	197465 242	197624 259
195320 160	196006 318	196480 299	196666 230	196926 239	197095 262	197466 242	197630 260
195325 160	196008 318	196490 299	196670 230	196930 240	197098 262	197470 241	197632 260
195327 160	196011 318	196495 299	196690 231	196935 240	197102 262	197471 241	197635 260
195330 160	196016 318	196496 299	196691 231	196940 240	197105 262	197472 241	197640 260
195340 160	196021 318	196500 229	196695 234	196942 285	197108 262	197473 241	197642 260
195350 160	196026 318	196501 229	196701 236	196945 285	197111 262	197474 241	197645 260
195625 251	196181 317	196502 229	196702 236	196950 240	197114 262	197475 241	197650 258
195630 251	196183 317	196503 231	196703 236	196952 240	197121 262	197480 242	197651 259
195700 281	196185 317	196504 231	196704 236	196955 240	197127 262	197481 242	197652 258
195701 281	196186 317	196510 227	196705 236	196956 239	197140 262	197495 255	197655 260
195705 281	196187 317	196511 227	196710 236	196957 240	197152 262	197497 256	197656 259
195706 281	196188 317	196515 227	196715 236	196960 240	197160 263	197499 253	197658 260
195708 281	196190 312	196516 227	196720 236	196961 239	197170 263	197500 253	197660 260
195709 281	196195 312	196518 229	196725 236	196962 240	197200 262	197502 253	197662 260
195710 281	196197 312	196520 227	196727 236	196965 240	197210 262	197504 253	197702 253
195711 281	196198 312	196522 227	196730 236	196966 239	197212 263	197505 253	197704 253
195715 281	196199 312	196523 227	196732 236	196970 240	197215 263	197506 253	197705 253
195716 281	196200 312	196524 227	196760 235	196971 239	197220 263	197509 253	197710 253
195717 281	196201 312	196525 232	196762 235	196975 239	197230 263	197510 253	197712 253
195718 281	196203 320	196527 227	196764 235	196977 239	197240 263	197512 253	197714 253
195720 281	196204 317	196530 232	196766 235	196989 242	197250 263	197514 253	197720 254
195721 281	196206 317	196531 232	196768 235	196994 242	197260 245	197515 253	197721 254
195723 281	196208 317	196548 226	196780 237	197001 242	197280 314	197516 253	197725 254
195724 281	196210 317	196550 226	196781 237	197003 242	197281 314	197518 254	197730 254
195725 281	196212 317	196551 226	196782 237	197014 262	197282 314	197519 254	197750 286
195726 281	196252 320	196554 226	196783 237	197016 262	197300 310	197520 254	197752 286
195730 282	196255 320	196555 226	196784 237	197017 262	197303 310	197521 254	197753 286
195731 282	196280 319	196556 226	196785 237	197019 262	197305 310	197524 254	197754 286
195740 282	196282 319	196560 226	196786 237	197020 262	197307 310	197525 254	197756 286
195741 282	196288 320	196562 226	196787 237	197021 262	197310 310	197526 254	197762 286
195750 282	196290 319	196563 226	196788 237	197022 262	197312 310	197528 254	197763 286
195751 282	196292 319	196565 230	196789 237	197024 262	197315 310	197529 254	197764 286
195760 282	196294 319	196566 230	196790 237	197025 262	197317 310	197530 254	197765 286
195761 282	196302 316	196570 230	196792 237	197027 262	197320 310	197531 254	197766 286
195762 284	196303 316	196575 230	196805 236	197029 262	197322 310	197534 256	197768 286
195764 284	196304 316	196576 230	196810 236	197030 262	197324 310	197535 256	197770 286
195768 283	196305 299	196580 231	196815 236	197032 262	197325 311	197536 256	197772 286
195770 283	196306 299	196581 231	196848 84	197033 262	197330 311	197539 256	197774 286
195772 283	196310 299	196590 231	196848 274	197035 262	197340 311	197540 256	197778 287
195774 283	196311 299	196595 234	196850 83	197037 262	197350 311	197541 256	197783 287
195775 284	196315 299	196600 228	196852 84	197038 262	197355 313	197544 256	197784 287
195776 284	196316 299	196601 228	196855 84	197040 262	197357 313	197545 256	197785 287
195780 283	196318 299	196602 228	196856 30	197041 262	197360 311	197546 256	197786 287
195785 283	196320 299	196605 228	196860 83	197043 262	197362 321	197549 256	197788 287
195786 283	196321 299	196606 228	196870 291	197044 262	197365 321	197550 255	197790 287
195787 283	196322 300	196608 228	196872 83	197046 262	197370 315	197552 255	197792 287
195788 285	196325 299	196612 227	196875 291	197048 262	197372 315	197554 255	197794 287
195790 284	196340 299	196613 227	196880 84	197051 262	197374 315	197555 261	197795 287
195792 284	196350 299	196617 227	196882 84	197052 262	197375 314	197556 261	197796 287
195795 285	196360 299	196622 227	196885 292	197054 262	197380 314	197558 261	197797 287
195796 285	196375 299	196625 232	196886 292	197056 262	197385 314	197560 261	197798 287
195800 284	196385 299	196627 232	196890 291	197057 262	197386 314	197561 261	197799 287
195900 280	196390 299	196628 227	196894 291	197059 262	197390 314	197562 261	197800 288
195901 280	196395 299	196629 227	196895 291	197060 262	197392 314	197565 261	197805 288
195905 280	196399 299	196630 232	196896 292	197064 262	197394 314	197601 254	197810 288
195906 280	196401 299	196631 232	196897 292	197065 262	197396 314	197602 258	197850 288
195910 280	196403 299	196632 227	196898 292	197067 262	197398 314	197603 254	197855 288
195911 280	196406 299	196633 232	196899 292	197068 262	197399 314	197604 258	197860 288
195915 280	196411 299	196652 226	196905 240	197070 262	197415 315	197605 254	197865 288
195916 280	196416 299	196653 226	196910 240	197073 262	197420 315	197606 258	197870 288

ÍNDICE CÓDIGO-PÁGINA

CÓD.	PÁG.	CÓD.	PÁG.	CÓD.	PÁG.	CÓD.	PÁG.	CÓD.	PÁG.	CÓD.	PÁG.	CÓD.	PÁG.	CÓD.	PÁG.
197872	288	198152	81	198266	219	198395	222	198544	279	198875	366	199305	350		
197873	288	198154	79	198267	219	198396	224	198550	279	198876	366	199306	351		
197875	288	198160	78	198268	219	198397	224	198558	279	198880	366	199308	351		
197877	288	198180	221	198269	219	198398	224	198600	276	198882	366	199310	350		
197880	288	198181	221	198270	220	198399	224	198601	278	198885	367	199311	351		
197882	288	198182	221	198275	220	198424	223	198602	278	198892	368	199313	351		
197900	288	198183	221	198276	224	198427	223	198603	276	198895	368	199315	350		
197905	288	198184	221	198277	224	198430	223	198604	276	198900	220	199316	351		
197910	288	198185	221	198278	224	198432	223	198605	276	198902	220	199318	351		
197915	288	198200	219	198279	224	198434	223	198610	276	198904	220	199325	351		
197920	288	198201	219	198285	221	198436	223	198611	278	198906	220	199326	351		
197932	290	198202	219	198286	221	198438	223	198612	278	198915	354	199332	351		
197934	290	198203	219	198288	221	198441	223	198613	276	198925	354	199333	351		
197936	290	198204	219	198290	221	198446	223	198614	277	198946	224	199335	305		
197942	290	198205	219	198292	221	198450	223	198615	276	198950	224	199350	349		
197944	290	198206	219	198294	221	198455	223	198617	277	198955	224	199351	351		
197946	290	198208	218	198297	221	198460	223	198619	277	198960	224	199355	349		
197950	289	198209	218	198299	221	198465	223	198620	233	198965	224	199356	351		
197955	289	198210	218	198300	221	198470	223	198621	277	198970	224	199360	349		
197960	289	198211	218	198301	221	198475	223	198622	277	198975	224	199361	351		
197965	289	198212	218	198302	221	198476	223	198625	233	198980	224	199362	349		
197970	290	198213	218	198304	221	198477	223	198630	233	198981	224	199363	351		
197972	290	198214	218	198306	221	198478	223	198632	233	198982	224	199364	351		
197975	290	198215	218	198308	221	198479	223	198650	234	198983	224	199365	342		
197976	290	198216	218	198310	221	198480	223	198655	234	198984	224	199367	342		
197985	290	198217	218	198312	221	198481	223	198658	234	199166	148	199368	342		
197986	290	198218	218	198314	221	198482	223	198660	234	199167	148	199369	342		
197987	290	198219	218	198316	221	198483	223	198668	235	199168	148	199370	342		
197990	355	198220	218	198317	222	198484	223	198670	235	199170	148	199375	341		
197992	355	198221	218	198319	222	198485	223	198675	235	199171	148	199377	341		
197993	355	198222	218	198321	222	198486	223	198676	235	199172	148	199380	341		
197995	355	198223	218	198322	222	198487	223	198680	231	199174	148	199382	341		
197996	355	198224	218	198324	222	198488	223	198748	235	199176	148	199400	338		
197997	355	198225	218	198327	222	198490	223	198750	234	199178	148	199401	337		
197998	355	198226	218	198330	222	198492	223	198755	234	199180	303	199403	337		
197999	355	198227	218	198332	222	198495	223	198758	234	199181	303	199405	338		
198002	353	198228	218	198334	222	198497	223	198760	234	199183	303	199409	339		
198004	353	198229	218	198336	222	198498	224	198776	235	199184	303	199410	339		
198005	353	198230	218	198338	222	198499	224	198802	364	199186	303	199415	339		
198010	353	198232	218	198341	222	198500	278	198803	364	199187	303	199416	339		
198050	289	198233	218	198346	222	198501	278	198805	364	199189	303	199417	339		
198052	289	198239	219	198350	222	198502	278	198807	364	199190	303	199425	338		
198054	289	198240	219	198355	222	198503	278	198810	365	199192	303	199426	337		
198070	289	198241	219	198360	222	198505	278	198815	365	199193	303	199428	337		
198072	289	198242	219	198370	222	198506	278	198816	365	199195	303	199430	338		
198074	289	198243	219	198371	222	198507	278	198818	365	199196	303	199433	340		
198100	77	198244	219	198372	222	198508	278	198820	365	199198	303	199435	340		
198101	29	198245	219	198373	222	198510	279	198821	365	199199	303	199436	340		
198105	77	198246	219	198374	222	198512	279	198826	300	199220	334	199443	340		
198106	29	198247	219	198375	222	198514	279	198828	300	199222	334	199444	340		
198110	76	198248	219	198376	222	198516	279	198830	300	199225	335	199445	340		
198111	29	198249	219	198377	222	198518	274	198832	300	199227	333	199446	340		
198115	76	198250	219	198378	222	198519	274	198835	300	199228	336	199453	340		
198116	29	198251	219	198379	222	198520	274	198850	359	199230	335	199454	340		
198121	76	198252	219	198380	222	198521	274	198851	359	199232	336	199455	340		
198122	76	198253	219	198381	222	198524	279	198852	359	199233	333	199456	340		
198125	82	198254	219	198382	222	198525	279	198855	359	199235	335	199463	340		
198130	82	198255	219	198383	222	198526	279	198856	359	199237	336	199464	340		
198132	79	198256	219	198384	222	198527	279	198857	359	199238	333	199465	340		
198134	81	198257	219	198385	222	198529	279	198860	367	199246	64	199466	340		
198135	80	198258	219	198386	222	198530	278	198861	367	199247	64	199472	339		
198140	292	198260	220	198387	222	198534	279	198863	367	199300	350	199473	339		
198142	292	198262	220	198390	222	198535	279	198865	367	199301	351	199474	339		
198150	78	198265	220	198392	222	198539	279	198870	366	199303	351	199475	339		

Pol. Ind. Itziar, T1 20829 Itziar-Deba (Spain) 

alycotools.com2015 

Alyco Tools 

alycotools 

T. +34 943 741 604 | alycotools.com